

SuperTrickler®

When True Precision Matters



ST101 Generation 1, 2 & 3 Owners Manual – General V3.3.2

Important Safety Instruction

Thank you for purchasing your Petersen Kowald SuperTrickler® ST101 smokeless gunpowder dispensing unit. We want you to get the best out of this easy to use and feature rich unit. Taking a small amount of time to read this manual will greatly benefit you in getting the SuperTrickler working for you and getting the most from its benefits and functionality.

The manual contains important safety, installation, and operating instructions for the SuperTrickler and compatible A&D balance (scale). Do not operate the SuperTrickler or balance unless you have read and understood the specifics of the instructions.

Petersen Kowald is a collaboration between Rex Petersen & Peter Kowald for the development of the SuperTrickler®. The manufacturing, ownership, sales, and support is the responsibility of Modgunn Security ApS (Denmark).

General Safety

Failure to follow these rules can result in property damage or serious injury. Always read and understand them before reloading ammunition.

- **Reload only when fully focused.**
Do not allow distractions such as television, visitors, or background noise.
- **Never reload under the influence.**
Alcohol, drugs, or medications that impair judgment or concentration must be avoided.
- **Understand your equipment.**
Read all reloading equipment instructions carefully. If unclear, contact the manufacturer before use.
- **Wear approved safety glasses.**
Ensure visitors in the loading area also wear protective eyewear.
- **Secure all equipment.**
Mount or place devices on a solid work surface, following manufacturer guidelines.
- **Maintain good housekeeping.**
Clean spills promptly. Keep only components needed for the current task on the bench.
- **Keep accurate records.**
The SuperTrickler can log powder batches, but you must ensure correct data entry. Label all ammunition and components clearly.
- **Store powder and primers safely.**
Keep them away from heat, flame, and children. Follow all local legal storage requirements.
- **No smoking, eating, or drinking in the loading area.**
- **Use original containers.**
Keep powder and primers in factory-marked packaging. Discard any components missing identification. Return materials to their containers immediately after use.
- **Limit powder on the bench.**
Keep only one container of propellant open at a time to avoid mistakes or mixing.
- **Follow published reloading data.**
Verify your manual is open to the correct cartridge page before loading.
- **Use only approved balances.**
The SuperTrickler is designed exclusively for A&D FZ/FX series balances. Warm up and calibrate the balance as recommended before use.

- **Keep the balance clean.**
Remove the powder cup, dust, and debris before calibration.
- **Handle calibration weights correctly.**
Ensure weights are accurate and clean. Use gloves or lifting tools—never bare hands.
- **Protect the balance.**
Do not drop the unit or place objects on it. If damaged, return it to the manufacturer or an approved repairer.
- **Avoid interference.**
Keep the balance at least 1 m (3 ft) from fluorescent lights. Do not use cell phones or strong transmitters nearby, as they may disrupt communication or calibration.
- **Minimize fire risks.**
Do not keep battery-powered devices (phones, tablets) near gunpowder.
- **Operate the touchscreen correctly.**
Use fingers or a soft blunt pointer only. Never use sharp or hard objects.

Warnings

These warnings highlight conditions that can damage the SuperTrickler® or create unsafe situations. Always follow them precisely.

- **Do not use with black powder.**
The SuperTrickler is approved for smokeless gunpowder only.
- **Never remove the bulk trickler tube while powder is in the hopper.**
Doing so will allow powder into the body of the unit and require cleaning by an authorized service center at your cost.
- **Micro SD card must be installed.**
The card blocks powder from entering the electronics bay. Do not fill or empty the unit without it.
- **Use only an appropriate power supply.**
 - Do not use the A&D balance power supply with the SuperTrickler.
 - The balance receives power directly from the SuperTrickler.
 - Power requirements:
Gen 1 & 2 units; use only the supplied 15Volt 4 Amp, PSU
Gen 3; 12Volt 2 Amp (30W) USB-C PD Charger.
It's important that the charger support 12V.
Some chargers only support 5V, 9V, 15V and 20V. They will NOT work with the SuperTrickler.

Warranty

The SuperTrickler® is covered by a two-year comprehensive warranty. This warranty includes:

- **Coverage:**
 - Main unit
 - Power supply (Gen 1 & 2)
 - MicroSD card
 - Cables and accessories
 - Shipping (both directions) for approved warranty repairs
- **Warranty period:**
Begins on the date of the supplied invoice from Modgunn Security ApS.

Transferable to second and future owners.

- **Proof of purchase required:**
 - Keep a copy of the original invoice — this is your warranty registration.
 - If you sell your unit, provide the invoice copy to the new owner.
 - Without the original invoice, warranty claims may be invalid.
 - Digital copies/images of the invoice are acceptable.
- **Claims:**
Contact: services@supertrickler.com.au

Limitations (Warranty Void If...)

- Security/warranty stickers are removed.
- Unapproved devices, wiring, or connectors are attached to the 25-pin expansion port or 9-pin scales port.
- Powder is loaded without the large rotation bulk tube in place.
- An unapproved power supply unit (PSU) is used.
- Physical abuse (as determined by Modgunn Security ApS) occurs.

Scales / Balance

Scales and balances are both weighing instruments, but they measure differently:

- **Scale:** Measures *weight* — the force of gravity acting on an object.
- **Balance:** Measures *mass* — comparing one object against another.

In reloading, the term “scale” (or “scales”) has historically been used to describe the weighing device. For consistency, this manual will use “scale” throughout when referring to the A&D FZ/FX series balance.

General Terminology

- **Scale:** Refers to the A&D FZ/FX series balance used with the SuperTrickler.
- **Weight:** The measured amount of powder displayed by the scale.
- **Powder:** Smokeless gunpowder only (never black powder).
- **Load / Charge / Drop:** Powder dispensed for the purpose of loading a bullet.
- **AI:** Acronym for *Artificial Intelligence*. In this manual, it refers to the SuperTrickler’s self-learning control system.
- **SD card:** Refers to the Micro SD card used in the SuperTrickler.

Disclaimer

Gunpowder is a hazardous material. Before using this equipment or attempting to reload ammunition:

- **Seek expert advice** on the proper use of all reloading products, handling procedures, and charge quantities.
- **Understand the risks.** Reloading involves dangerous materials and processes.
- **Responsibility:** Rex Petersen, Peter Kowald, SuperTrickler®, and Modgunn Security ApS accept no liability for harm or damage resulting from use of the SuperTrickler® or the reloading process.

This Document

This document was specifically written for the SuperTrickler® ST101 and forms part of a three-part manual set. The **Owner's Manual – General** contains broad information about the SuperTrickler®. The **Owner's Manual – Installation** covers scale setup and basic configuration. The **Owner's Manual – Profile** focuses on powder and preset profile settings, as well as detailed dispensing operations.

SuperTrickler & Modgunn Security ApS, maintain the right to change this document and or the firmware at any time without notification.

This manual and all its parts should be read and understood before operating the SuperTrickler. If you have questions, or are having difficulty understanding any of this documentation, please contact our support desk: support@supertrickler.com.au

To find the latest version of this document, and all applicable downloads, please go to one of the applicable places on our website:

Home: <https://supertrickler.com.au>

Documentation: <https://supertrickler.com.au/documentation/>

Firmware Downloads: <https://supertrickler.com.au/files/>

Powder Database files: <https://supertrickler.com.au/powder-database/>

Miscellaneous files: <https://supertrickler.com.au/miscellaneous/>

Also, there are several Facebook groups related to the SuperTrickler®:

SuperTrickler FB Group: <https://www.facebook.com/groups/174920460551694>

SuperTrickler FB Owners Group: <https://www.facebook.com/groups/1226539671258233> (you will need your order number to join this group) The owners group is where you will find the best support, only owners are in this group so that questions can be asked freely without outside interference.

Splash Screen background designed by coolvector / Freepik

Table of Contents

Table of Contents

Introduction.....	9
Vibrator Warmup Option	12
<i>Menu System & Button Arrangements</i>	14
Special Buttons	15
Hold to activate	15
Two State Buttons – OFF or Value.....	15
Quick Return.....	15
Artificial intelligence Self-Learning.....	15
Heuristics Reset:	15
Main Sub Menu	16
Soft keypads	17
Numeric Keypad	17
Alphanumeric Keypad	18
Dispensing	19
From the Main Menu	19
Dispensing Screen.....	19
Charge Setpoint.....	23
Powder / Preset / Mode / Prime - Selection Menu.....	24
Powder & Pre-set Profile Database.....	24
Powder Selection.....	24
Pre-set Charge Profile Database.....	25
Selecting a Preset profile.....	26
Creating a new pre-set	27
Modes.....	28
Ladder Mode Setup	28
Top Up Mode.....	29
Weight Logging Mode	30
Empty Hopper.....	31
<i>Operational</i>	32
Tools & Settings Menu	32
Preferences & Settings	32

Preferences.....	33
Automatic power up times.....	36
Motors.....	37
Change Bulk Tube.....	37
Motor Testing.....	38
Calibrate Scales.....	39
Scale Calibration Weight.....	39
System.....	40
System Menu.....	40
Peripherals.....	41
SD Card.....	41
Scales (Balance).....	43
Incorrect scale speed setting.....	45
Configured Scales Not Found.....	45
Programming the Scale.....	45
Powder Cup Scales Monitoring.....	48
Powder Cup Laser Sensor.....	49
Date & Time.....	50
Default Profile.....	50
System Core.....	51
Firmware Update.....	52
Important: Roll Back Strategy.....	52
Install.....	53
Update Error codes.....	54
Restore.....	56
Deep System Settings.....	57
Powder Flow Graph.....	58
Charge Weight Drift Monitoring.....	58
Micro SD Card.....	59
Card Type.....	59
Card Format.....	59
Card Removal and Insertion.....	59
Interface Ports.....	60
Log Files.....	61
Analysis Log File.....	61

Log Files Backup.....	62
Specifications for Generation 1 & 2	63
<i>Generation 3 Specific</i>	64
Power Supply Unit (PSU)	64
Door Switches.....	64
USB Flash Drive.....	65
Accessing the USB flash drive functionality.....	66
Specifications for Generation 3	67
Support	68
A Friendly Note on Support	68
Feedback.....	68
Appendix A: Upgrade/Firmware Naming Conventions	69
Appendix B: Common Problems.....	71

General

Introduction

The SuperTrickler® ST101 is the most advanced gunpowder dispenser available today. It combines speed, precision, and flexibility for both novice and experienced reloaders.

Development

- Nearly three years of design and testing went into creating this highly sophisticated, user-friendly, and accurate dispenser.
- Built for home users who demand professional-grade performance.

Accuracy

- Uses an external A&D laboratory balance with precision of **0.02, 0.01, or 0.002 grains** (depending on model).
- Powder delivery is managed by a **two-tube system**:
 - Rotating bulk tube for fast initial dispensing.
 - Fine vibrating tube for precise final trickling.
- Result: quiet, fast, and highly accurate charges.

Ease of Use

- **Novice users:** AI-driven self-learning mode works effectively out of the box.
- **Expert users:** Full manual control for fine-tuning performance with any powder type.
- The SuperTrickler is not “hard to use” — it is deeply configurable. Flexibility requires understanding, and reading the manual ensures success.

Artificial Intelligence Integration

- Employs **symbolic AI (GOFAI)** for self-learning, proactive monitoring, and dynamic control.
- AI adapts to powder profiles and preset charges, allowing personalized operation.
- Unlike fixed-sequence dispensers, the SuperTrickler makes intelligent adjustments during use.

Unique Features

- **Laser safety check:** Detects whether the powder cup is in position before dispensing.
- **Standalone color touchscreen:** Fast, clear, and intuitive interface.
- **Extensive powder database:** Easily updated or personalized; includes tracking and reporting for legal compliance in some regions.

Comprehensive Data Logging

- Multiple log files record successful and failed charges, settings, and AI decisions.
- Logs are compatible with spreadsheet programs for easy review.
- Detailed error records simplify troubleshooting and remote support.
- Date format can be customized to suit regional preferences.

Other Notable Features

- Automatic laddering.
- Unlimited preset charges.
- Configurable self-learning (enable/disable).
- Automatic warm-up timers.
- Sleep and power-down options.
- Sectional factory restore functions.
- Easy balance calibration via touchscreen.
- Verified firmware updates with rollback support.
- Visual and audio feedback for successful/failed charges (customizable).
- Expansion port for external devices (label printers, sensors, etc.).



A Friendly Note on Support

We know that seeking support can sometimes feel frustrating — especially when things don't work as expected. Many support requests arise because key sections of the manual or firmware update guide haven't been fully reviewed. This can lead to confusion around basic concepts or terminology.

Why Reading the Manual Matters

- The Owner's Manual is comprehensive, but it's designed to help you unlock the full potential of your SuperTrickler.
- Skipping sections often results in misunderstandings, such as "How do I do that?" questions that are already explained in detail.
- Using consistent terminology from the manual makes communication with support faster and clearer.

How We Handle Support Requests

- Our team may ask you to review specific sections of the manual before troubleshooting.
- This ensures we can focus on solving your issue rather than re-explaining fundamental operations.
- The **Profile Manual** is especially important for understanding advanced features and achieving the best results.

Our Commitment

- We're here to help you succeed with your SuperTrickler.
- By reading the manual carefully, you'll save time, reduce frustration, and get the most out of your system.
- Thank you for being part of the SuperTrickler community.



The Trade-off Between Speed and Consistency

The SuperTrickler® delivers **accurate charges every time**. What varies is the **consistency** of powder drops when balancing speed against reliability. Faster dispensing saves time but may occasionally produce **overshoots** — drops outside your preferred tolerance.

The Trade-off

Slower dispensing:

- Highest consistency.
- Each drop may take ~20 seconds.
- Example: 100 drops = 33 minutes 20 seconds.

Faster dispensing:

- Slightly lower consistency (e.g., 1 in 10 overshoots).
- Each drop may take ~6–10 seconds.

Example:

- 6 seconds per drop → **11 minutes total** (saving 22 minutes).
- 10 seconds per drop → **18 minutes 20 seconds total** (saving 15 minutes).

Choosing Your Approach

- Maximum consistency: Dispense slowly to minimize overshoots.
- Time efficiency: Dispense faster, accepting occasional overshoots.
- Balanced mode: Adjust speed to suit your preference for consistency vs efficiency.

 Note: 100% consistent drops are almost possible (depending on the power type) if you prioritize slower dispensing. Faster operation trades a small number of overshoots for significant time savings.

Vibrator Warmup Option

Warming up the vibrator at the start of a session is optional and simply helps release tension on the rubber mount before the vibrator calibration. This function is accessible from the Main Menu or via the Profile menu → Vibrator Speed.

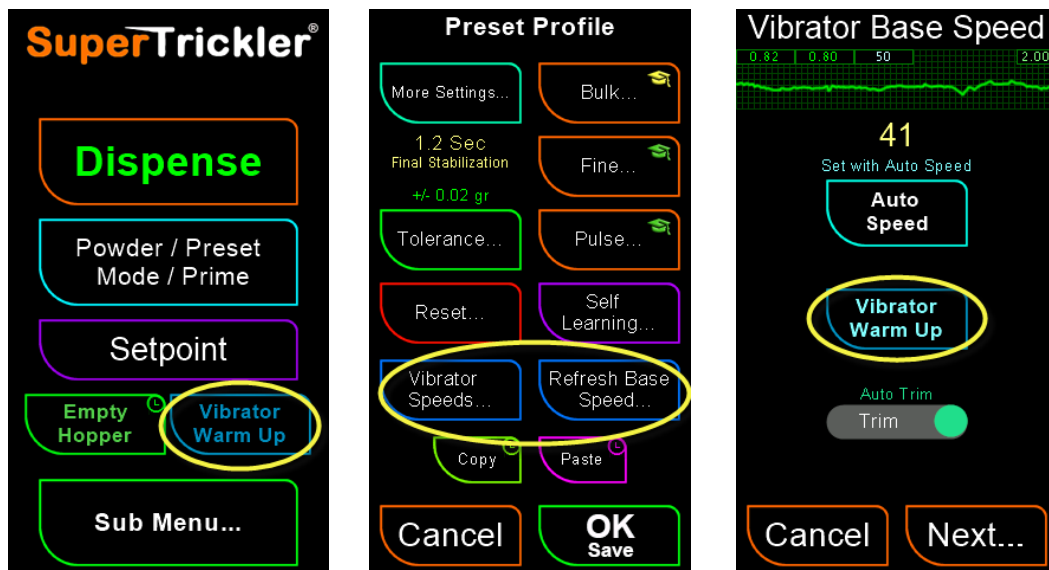

Warm-up Procedure

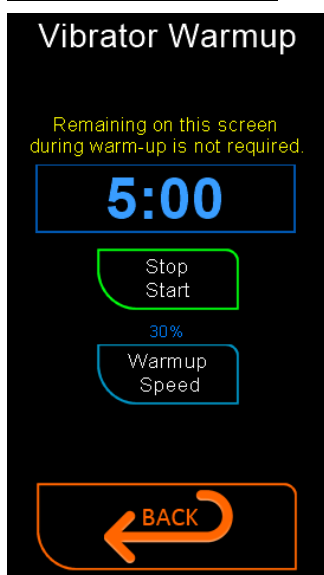

- **Background operation:**

When started from the Main Menu, the warm-up cycle continues to run in the background while you navigate to other screens and perform other tasks. The only exception is the Vibrator Base Speed screen, which will immediately cancel any active warm-up cycle when opened.

- ✳ **Start/Stop control:**

Use the green button to start or stop the warm-up.

- Once started the vibrator runs for 30 seconds.
- To stop early, press the green button again.

⚠ **Warning:** Please ensure the cup is in position before running the warm-up.

- ✳ **Vibrator Warmup Speed:** Sets the speed used during the vibrator warm-up cycle. If the speed is too high, it may cause excessive wear on

the unit, and any powder in the hopper may be thrown past the cup. If the speed is too low, the warm-up may be ineffective. This value should be adjusted to gently approximate the vibrator's normal operating speed. Units fitted with the generation-3 or upgraded silicon motor mount typically require less speed than those using the original rubber mounting system.

Warmup Operation

The warmup cycle runs for 5 minutes, operating for 3 seconds and then stopping for 7 seconds, mimicking an intensive approximate duty cycle. This approach warms the vibrator mount gently and evenly without causing excessive wear. If the cup requires emptying during this process, the seven-second pause provides more than enough time to do so without interrupting the operation. During the warmup, a beep will sound every 60 seconds to remind you to check the cup level if powder is present in the hopper.

Calibration Procedure

For best results, calibrate the vibrator base speed after the tube has been unused for some time and at the start of each session.

- **Pre-run with powder:**
If the tube has not been primed, run the vibrator with powder using the vibrator warm-up to prime and stabilize the tube.
- **Empty the cup first:**
Ensure the powder cup is empty before calibration.
- **Proceed with calibration:**
Follow the on-screen instructions to set the base speed.

Filling and Emptying the Gunpowder Hopper.



Changing powders requires careful handling to maintain **consistency** and prevent contamination. Always ensure the hopper and scale are clean before adding new powder.

Filling the Hopper

- **Do not overfill.**
- **Optional funnel:** A short funnel may be used in the hopper opening to aid pouring.
- **Steps:**
 1. Confirm the **Micro SD card is installed** (prevents powder entering the electronics bay).
 2. Pour **only smokeless gunpowder** into the hopper.
 3. Do not fill past the hopper opening.
 4. If using a funnel, it may remain in place during operation.

Emptying the Hopper

You do not need to power-down the SuperTrickler to empty the hopper. Powder may be returned to the original container or a catch bowl.

- **Important:** The rotating bulk tube must remain in place during emptying.
- **Steps:**
 1. Confirm the **Micro SD card is installed**.
 2. **Remove the powder cup.**
 3. From the main menu, press and hold the Empty Hopper button for ~1.5 seconds.
 -  This prevents accidental activation of other menu buttons.
 4. Lift the SuperTrickler gently from the scale (do not lift the scale).
 5. Tilt the unit backwards ~45° to expose the hopper gate.
 6. Position over a catch bowl or funnel into the original container.
 7. Open the hopper gate fully to release powder.
 8. Once flow stops, close the gate and keep the unit tilted.
 9. Rotate the bulk tube clockwise several times by hand while gently shaking the unit.
 10. Re-open the gate to release any remaining powder.
 11. Close the gate and reseal the unit on the scale.
 -  The SuperTrickler cannot be seated unless the hopper gate is fully closed.
 12. **Touch the screen anywhere for at least 3 seconds** to close the filling screen and return to the main menu.

 **Warning:** Do not force the SuperTrickler onto the scale. If the hopper gate is not fully closed, damage may occur

Menu System & Button Arrangements

The SuperTrickler menu system is designed around workflow and practical use. It is divided into three main sections:

- **Dispensing:** Core functionality for powder selection, setpoints, and dispensing operations.
- **Operational:** Tools, settings and preferences for general functionality.
- **System:** Advanced configuration, restore options, and testing.

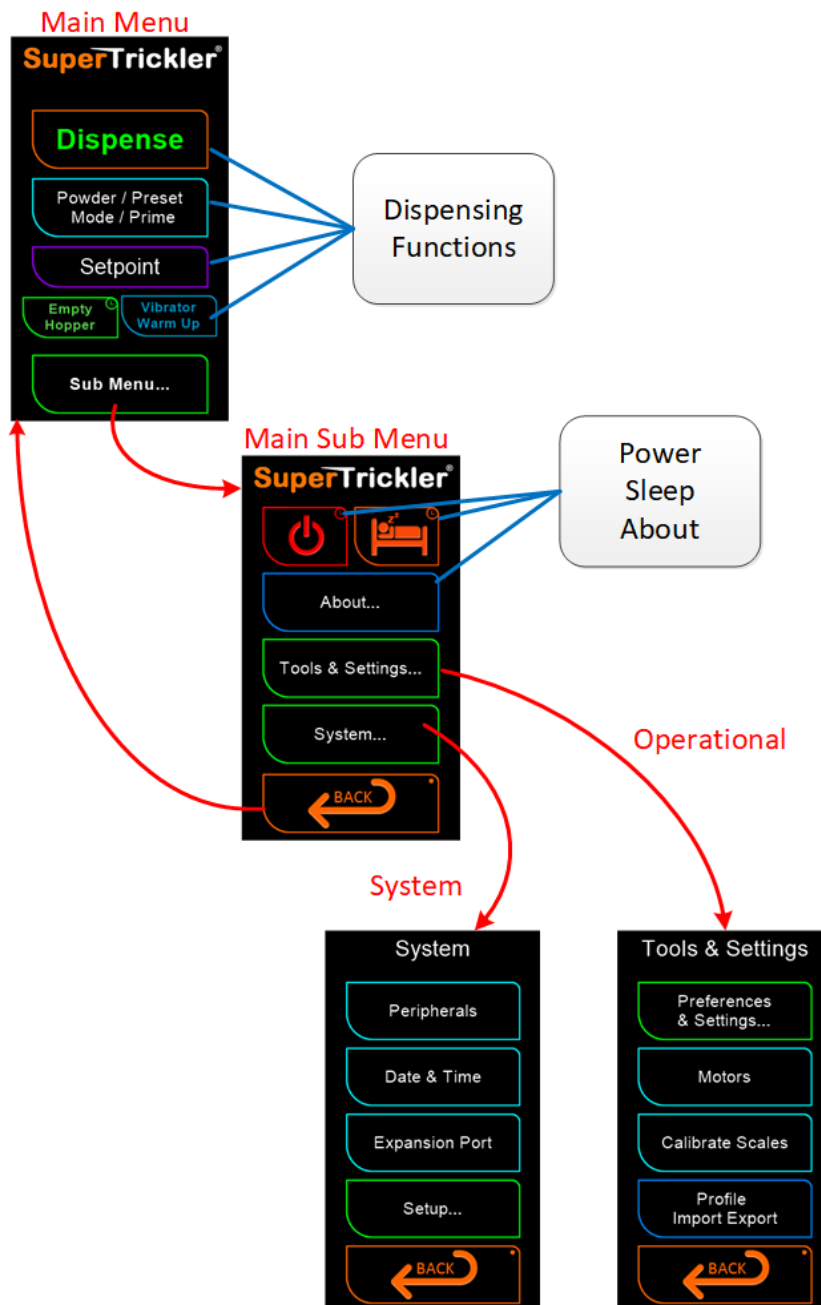

Special Buttons

There are several types of special buttons that you will find throughout the system.

Hold to activate

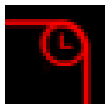

Any button in the system that has a small clock in the top right-hand corner will need to be held in for a time before activation will occur. This feature is designed to ensure that these particular buttons are not accidentally hit, causing unintentional activation.

The green work light will flash once timed out.

Two State Buttons – OFF or Value,



Any button in the system that displays the international power icon in the top-right corner is a two-state button: **OFF** or its configured **Value**.



- To turn **OFF** – Press and hold the button for half a second, until a long beep is heard.
- To turn back **ON** – Simply press the button; the current value will be displayed.
- To edit the **Value** – Press the button again while the value is shown.

Quick Return



Some buttons and many of the back buttons will have a dot in the top right-hand corner. This indicates that the button is a quick navigate button and works as follows...

- Pressing the button normally (finger on, finger off quickly) will return you back to the previous menu.
- Pressing and holding the back button for around 1 seconds will navigate you directly to the dispensing screen
- Other button will take you to a convenient location.
See notes on the button descriptions for its alternate use.

Artificial intelligence Self-Learning

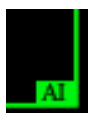

Any button in the profile that has the AI icon in the bottom right-hand corner, signifies that this control can be changed by the AI self-learning.

Heuristics Reset:



This is a special kind of button used on the self-learning screen, heuristics buttons. Pressing it once will reset the self-learning heuristics, upon pressing the button its appearance will change to a normal button. Pressing it again will allow you to set a new heuristics threshold.

Main Sub Menu

Accessed from the Main Menu, this submenu provides system-level functions:

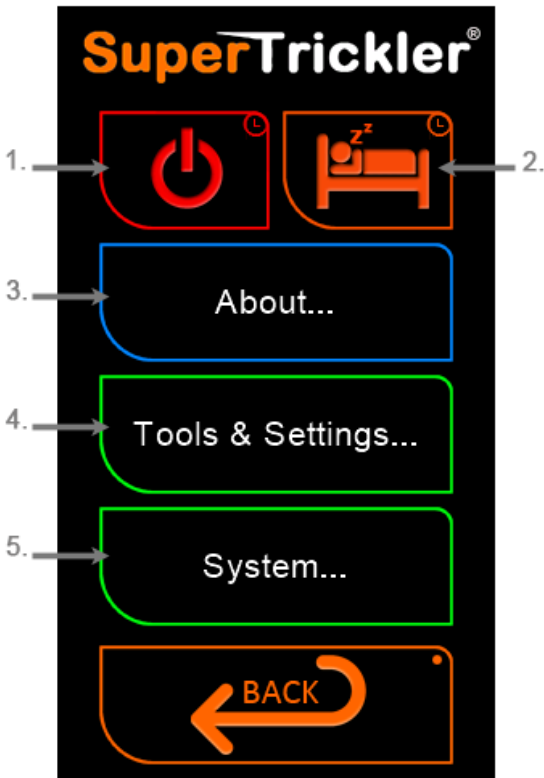

1. ✨ **Power Down:** Puts the SuperTrickler into hibernation and turns off power to the scale. Touch the blank screen to reactivate.
2. ✨ **Sleep:** Puts the SuperTrickler into hibernation and only turns off the scale display but keeps the scale powered on. Touch the blank screen to wake.
3. ✨ **About...** Displays system information (serial number, powder file version date). Includes a QR code link to support support@supertrickler.com.au
4. ✨ **Tools & Settings...** Opens the operational tools and settings menu.
5. ✨ **System...:** Provides access to advanced submenus (setup, peripherals, date/time, expansion port configuration).

Soft keypads

The SuperTrickler® uses on-screen soft keypads for entering values and settings. These keypads are designed for accuracy, consistency, and ease of use.

Numeric Keypad

Used for entering numbers (weights, times, values, setpoints).

Is the most used soft keypad, and is flexible in functionality. The numeric keypad has two flexible keys that will change according to the type of values being entered. An example of this is the entry of the date or time; where the spacer will change to '/' for dates and ':' for time. In the case of date and times the system will generally automatically populate the date and time spaces as required.

Note: Often the system will either limit you to an entry range or automatically change the value if it's out of range.

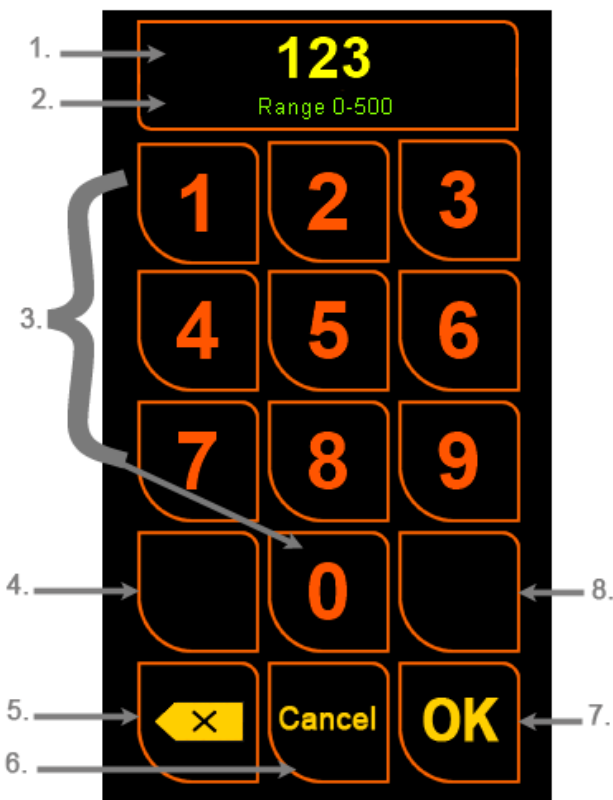

1. The entered value display.
2. Prompt display. This contains information relating to the value you are entering.
3. ✳ Number keys.
4. ✳ **Left flexible key.** This can be blank or have the following functionality...
 - ± = Toggle the value between positive / negative
 - (+/-) = Add the entered amount to the existing value
 - am/pm = toggle between am and pm time.
 - OFF, a flag to disable the functionality of the device or option being edited.
5. ✳ **Backspace.**
6. ✳ **Cancel** the entry and exit.
7. ✳ **Accept** the entry and exit.
8. ✳ **Right flexible key.** This can be blank or have the following functionality...
 - . = Decimal
 - / = Date spacer
 - : = Time spacer

Alphanumeric Keypad

The alphanumeric keypad is designed to you allow to enter a text string of alphanumeric characters both in upper and lower case, punctuation and symbolic characters. Because of the limited size of the display, the alphanumeric keyboard is split into multiple sections, accessible by using the key range scroll buttons.

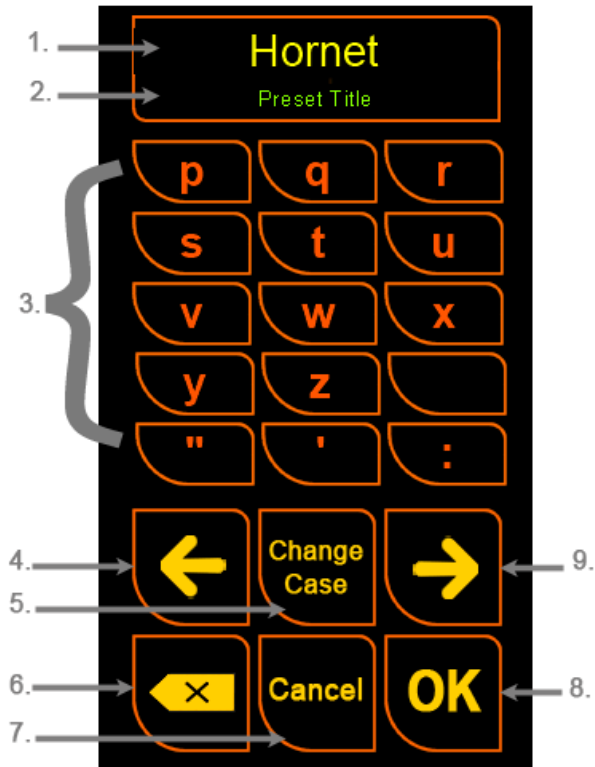

1. The entered text string display.
2. Prompt display. This contains information relating to what you are entering.
3. ✳ Text keys.
4. ✳ Key range **scroll left**.
5. ✳ Toggle the **case** of alphabetical keys.
6. ✳ Backspace.
7. ✳ **Cancel** the entry and exit.
8. ✳ **Accept** the entry and exit.
9. ✳ Key range **scroll right**.

Dispensing

From the Main Menu

The **Dispensing Menu** is the primary screen for operating the SuperTrickler®. It provides access to powder selection, setpoints, and dispensing controls.

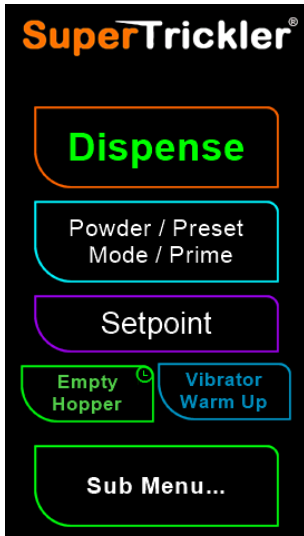

✳ **Dispense:** will take you to the dispensing screen to begin the dispensing process.

✳ **Powder / Preset / Mode / Prime** will take you to a submenu, allowing you to select the desired feature.

✳ **Setpoint:** allows you to change the charge target set point (amount of powder in weight). Once the charge is set you will be taken directly to the dispensing screen.

✳ **Empty Hopper:** Use this when emptying the unit of powder. It will prevent accidental pressing of buttons on the screen.

✳ **Vibrator Warm Up:** Run the vibrator to warm up the mounting rubber.

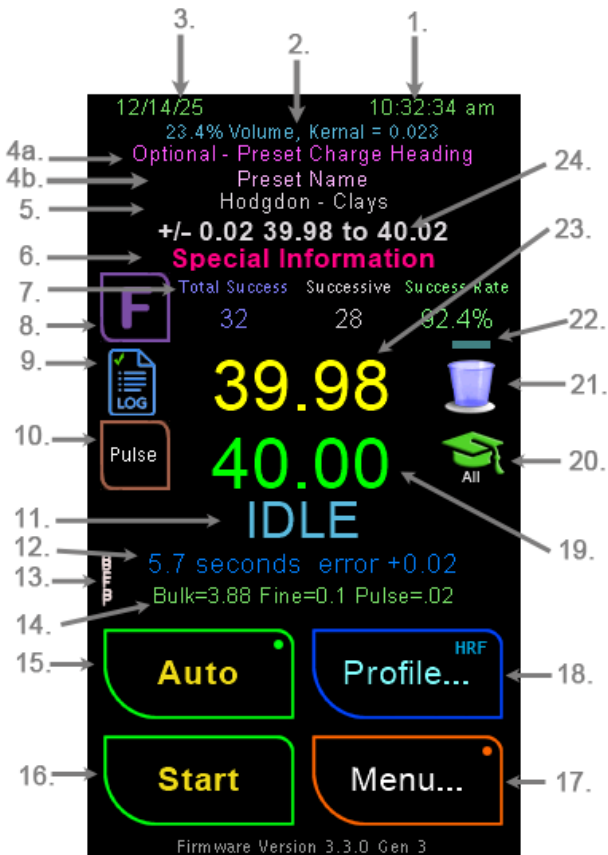

Dispensing Screen



1. [Time](#).
2. Optional [pre-set](#) shell volume as percentage of the charge.
3. [Date](#).
- 4a. Optional [pre-set](#) charge Heading.
- 4b. Optional [pre-set](#) charge Name.
5. [Powder brand and type](#).
6. [Special mode](#) (ladder, top up or external) or other information.
7. Metrics (Statistical) Data
- 💡 **Note:** During the Self-Learning process, a failed charge will not be recorded as long as the instrument remains in learning mode.
8. ✳ Function button for the quick access submenu.
9. Shows if [successful log](#) file enabled.
10. ✳ Optional Manual Pulse button, or if external control is enabled this will show the robot status.
11. Shows operational status.

12. Charge results, time and error amount.

13. Instruments used display. This is especially useful when HRF metadata is active.

14. Instrument meta data inflight or time amount after the charge.
15. ✳ Enable Automatic mode button
* Holding this button will take you directly to the Mode Menu screen.
16. ✳ Start charge button.
17. ✳ Return to main menu button.
* Holding this button will take you directly to the Powder or the Preset selections screen, depending on the current selection type.
18. ✳ Powder profile button. **See separate profile document for details.**
* Touching this button will take directly to the Powder or the Preset selections screen, depending on the current selection type.
* Holding this button will take you directly HRF screen for quick fine tuning.
19. Set point amount
✳ Touching this value will open the setpoint editor.
20. Shows if [AI self-learning](#) is enabled and status by color.
✳ When Self-Learning has entered Monitor Mode  or has been turned off,  this space will change to a button that enables extended learning.
21. Shows powder cup status, errors or instrument animation.
22. Shows if the [laser](#) is enabled and status by color (see Note below).
23. Scale Weight
24. [Tolerance level and tolerance range.](#)

General Notes

Motor Activity:



When an instrument motor is running, the cup display is replaced with a crosshair animation to indicate operation.

Laser Status Indicators

If the laser is enabled (see *System → Peripherals → Laser*), its color indicates the following:

- **Hidden:** Laser not enabled.
- **Blue / Grey:** Laser active but no measurement established.
- **White:** No cup detected.
- **Green:** Empty cup detected.
- **Red:** Cup detected with content.

External Control



- If the **Robot icon** is displayed, external control is enabled.
- In this mode, the SuperTrickler® will **only function** when connected to an external controller.
- To disable external control, use the ***Tools & Settings → Preferences & Setting → Preferences***

Pulse Button

Note: The Pulse button is optional. It must be enabled from the **Dispensing Screen Options (Tools & Settings → Preferences & Setting → Preferences)**.

This text assumes the button is enabled (not the default) and set to **Auto Quick Touch**.

Location

- The Pulse button appears on the **Dispensing Screen**.
- It is the **brown button** located just below the **LOG icon**.

Operation

- **Quick Touch:**
 - Activates automatic pulse cycling.
 - Continues until the weight changes.
- **Press and Hold:**
 - Initiates pulsing operation.
 - Continues until the button is released.
- **Behavior:**
 - Operates according to the current **pulse instrument settings**.
 - Settings can be adjusted in the options menu.

Function Sub-Menu (the F button)

Pressing the Function (F) button opens a sub-menu that provides quick access to the following operations:

- Reset Dispensing Screen Statistics
- Reset Hopper Powder Used (see Hopper Powder Alert System below)
- Mark Log Files
- Select Instrument Metadata or Used Information

Changes made within the Function screen will only take effect if the OK button is pressed. Selecting Cancel will discard any changes and return you to the main dispensing screen.

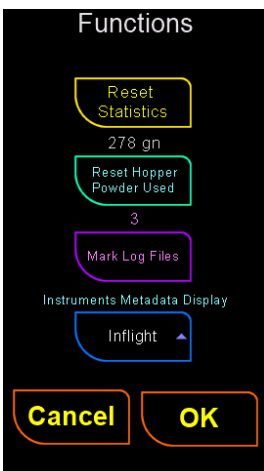

Statistics Reset

This option resets the dispensing screen statistics. When selected, the function will highlight to indicate it is active, but the reset will not occur until **OK** is pressed—allowing the operator to deselect it if needed.

Reset Hopper Powder Used

This is part of the Hopper Alert system (see below). It can be reset at any time. The displayed value reflects the current Hopper Alert Powder Used amount. Its operation mirrors that of the Statistics Reset.

Mark Log File

This special function writes the selected value to the Load and Analysis log file for future reference.

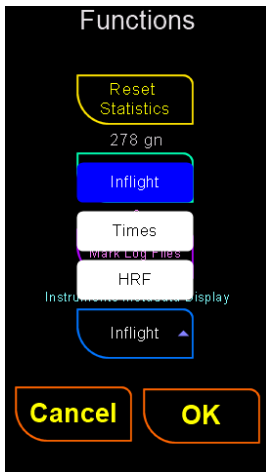

✳ Instrument Metadata Selection

This selector allows the operator to quickly choose the type of metadata displayed on the dispensing screen, touch the green button to bring up the options:

- **Inflight** ✳ shows the recorded inflight data for each instrument used
- **Time** ✳ displays the duration each instrument was active
- **HRF** ✳ Display the Fine High-speed time, Ramp-down time and the Final-phase time. If the Fine did not run then the Time metadata will be displayed instead.

As with other settings, changes will only apply once **OK** is pressed.

Hopper Powder Alert System

The Hopper Powder Alert system monitors the **amount of powder used** and issues an alert when the target threshold is reached.

⚠ Note: This system is theoretical — it does not directly measure powder in the hopper. Instead, usage is tracked by charge weight. The target threshold is set individually in each profile (preset or powder) under **More Settings...**

How It Works

- When a charge is successful, the powder used is added to the register.
- When the register reaches the **Powder Level Alert** value set in the profile, a warning is issued as the cup is removed from the pan.
- The powder usage register resets automatically:
 - At the start of each session.
 - When a new powder or preset is selected.
- The register can also be reset manually:
- From the **Function menu** on the dispensing screen.
- When the alarm is activated.
-

💡 Tip: The current register value is displayed on the Function screen, allowing you to monitor powder usage and detect changes in dispensing behavior.

Why Dispensing Behavior Changes

Powder is granular. When the hopper is full, the weight compresses the grains at the bottom and at the tube entry point.

- **Full hopper:** High compression reduces flow properties.
- **As powder is used:** Compression decreases, flow becomes faster.
- **Eventually:** Flow characteristics may fall outside the profile's control factors, increasing the chance of **overshoots**.

Alert Behavior

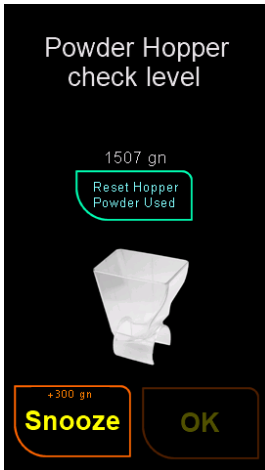

- The Hopper Powder Alert activates when the threshold is reached and the empty powder cup is returned.
 - At this point, **Auto mode** (if selected) is suspended and a warning screen appears with reset options.
- Options When Alarm Pops Up
- **Snooze:** Adds 300 grains to the target threshold. The alert disappears and normal operation continues.
 - **Top-Up & Reset:**
 - Add powder to the hopper.
 - Press **Reset Hopper Powder Used**.
 - This enables the **OK button** to confirm the reset.
 - Assumes a fully topped-up hopper, and operations continue until the register again reaches the threshold.

Profile Settings

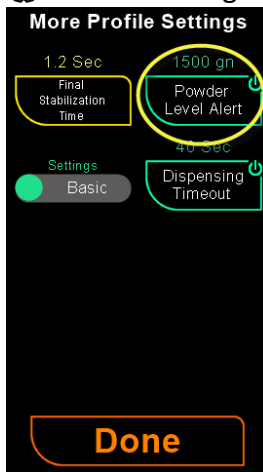

- Each target threshold must be set in the profile.
- **Default for new profiles:** 1500 grains.
- **Existing profiles:** Should be set to **OFF** if the alert is not required.
- The alert can be **disabled** by pressing and holding the Powder Level Alert button.

Hopper Volume Guide

- ~700 grains: Covers the powder baffle at the bottom of the hopper.
- ~2000 grains: Powder level 75 mm (3") below the top.
- ~4000 grains: Powder level 50 mm (2") below the top.
- ~7000 grains: Powder level 25 mm (1") below the top.

Charge Setpoint

Setting the charge setpoint can be achieved by two methods and is a simple matter of entering the value into the keypad and pressing OK.

Method 1. Is from the main menu, pressing the **[Setpoint]** button.

Method 2. Is from the dispensing screen, by pressing the set point value field.

Powder / Preset / Mode / Prime - Selection Menu

This menu provides the user with the ability to choose a powder, select a preset, or choose an operational mode such as laddering. It also includes functionality to prime the dispensing tubes before use.

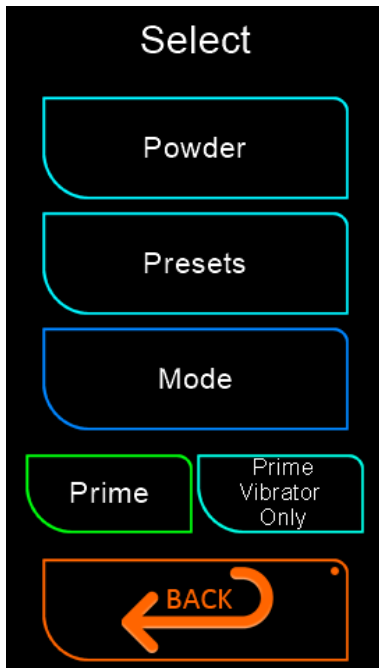

✳ **Powder:** will take you to the Power selection menu.

✳ **Preset:** will take you to the pre-set selection menu.

✳ **Mode:** Will allow you select the mode of operation, Normal, Ladder or Top-up modes.

✳ **Prime:** Primes both tubes together.

✳ **Prime Vibrator Only:** used to prime slow moving powders.

💡 **NOTE:** It is highly recommended to prime a new powder before starting a session

Powder & Pre-set Profile Database

The characteristics of every powder are different. The SuperTrickler® maintains a database on the micro-SD card that records the profile of each powder.

- When a powder is selected again, its stored profile is automatically loaded.
- If no profile exists, the system creates one using a default template & settings from the database.

Powder Selection

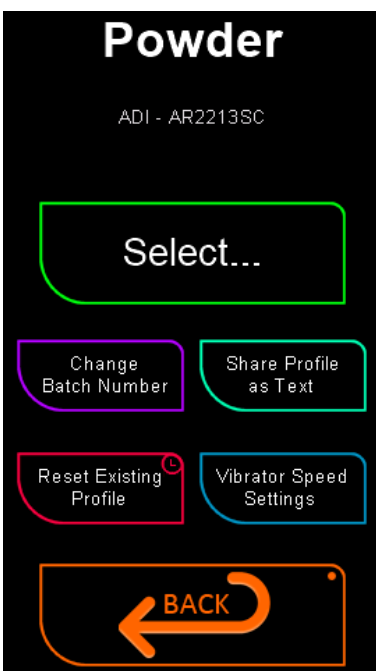

✳ **Select:** will take you to an extensive list of powders currently on the market. The list is broken down into two sections: firstly, the powder brand (manufacture) and secondly, the powder type or name.

✳ **Change Batch Number:** in some countries the recording of powder batch numbers and usage is a legal requirement. Also, it is not unusual for precision shooters to keep a record of the powder batch with their loads. The batch number is recorded in each powder's profile record.

✳ **Share Profile as Text:** This function saves all selected powder profile settings to a text file located in the SD card's shared folder. The file can be retained for record-keeping or shared with interested parties as needed.

☼ **Reset Existing Profile:** Once a powder has been selected, a profile is created for that powder using a combination of the default profile and any powder-specific settings defined in the powder database. The next time the powder is selected, this existing profile will be used. Pressing and holding this button will restore the profile to the current default settings, refreshed with the settings from the powder database.

☼ **Vibrator Speed Settings:** This will allow you to change the vibrating motor speed range. The actual speed range represents 1 to 100%.

Important: This must be set when an un-profiled powder is selected. See [Vibrator Speed Setting procedure](#).

💡 **Note 2:** For the latest powder.dbl database go to the download area at:
<https://supertrickler.com.au>

Download the file and copy it to the root directory of the SuperTrickler's Micro SD card. Or you can edit the file yourself following the format of the file.

Powder Selection Colors



With the additional data in the powder.dbl file, we have added the ability to change the button text color depending on what attributes may have changed.

White Text: No changes to the profile (it may contain average kernel weight).

Green Text: Only the tolerance values have been altered.

Yellow Text: Other profile fields have been altered as well as possibly the tolerances. This functionality is being phased out in general.

Pre-set Charge Profile Database

The SuperTrickler® allows an unlimited number of pre-set charges to be added. Pre-sets are extended versions of powder profiles, containing additional information and treated as separate profiles from the standard powder profiles.

Pre-sets are organized under headings, with each heading containing a group of pre-set names. There is no practical limit to the number of headings or pre-set names, and they are arranged as shown in the following example..

Heading 1

- Name 1
- Name 2
- Name 3
- (Unlimited Names)

Heading 2

- Name 1
- Name 2

Name 3
 (Unlimited Names)
 Heading 3
 Name 1
 Name 2
 Name 3
 (Unlimited Names)
 (Unlimited Headings)

The additional fields held in a pre-set are as follows...

1. Pre-set Heading
2. Pre-set Name
3. Charge Set point.
4. The shell (cartridge) volume.

Note 1: The pre-set menus allow you to change the **powder batch number**; however, this information is not stored within the pre-set profile itself. Instead, it is stored separately and shared with the **Powder Profiles** data. Changing the batch number in either the powder profile or the pre-set profile updates the same shared record

Note 2: An advantage of using a pre-set over a simple powder profile is that the volume of the cartridge (shell) can be recorded. When dispensing, the percentage of the volume used by the charge will be displayed and logged in the 'loads.csv' log file.

Selecting a Preset profile

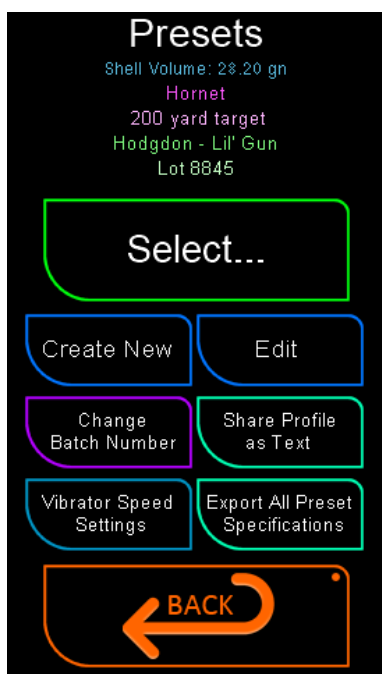

Pre-sets are an easy way to select common loads and (like the powder) is a simple list of headings and sub-headings. An example may be a heading of 'Hornet', then a sub-heading selection of '200-yard target'. Each Heading and Name can be up to 30 characters in length.

When you first create a pre-set, you must also select a powder brand and type. If the profile exists for the powder selection, then it will be copied into the profile of the pre-set, otherwise the default will be used.

Note: The pre-set profile will run its own profile and not the powder's profile; any changes to the pre-sets profile will not change the original powders profile; however, the powder batch number is linked to the powder's profile.

Change Batch Number: The batch number is common with the powder profile, changing the batch number here is identical to changing in the powder menu.

Share Profile as Text: This function saves all selected powder profile settings to a text file located in the SD card's shared folder. The file can be retained for record-keeping or shared with interested parties as needed.

✳️ **Export All Preset Specifications:** Generates a preset.csv file in the \log folder containing a list of all your preset specifications: Date, Time, Heading, Name, Powder, Type, Setpoint, Tolerance, and Volume.

This file is especially useful when updating firmware that renders existing profiles incompatible. The saved data can be manually re-entered into the new system to restore each preset.

✳️ **Vibrator Speed Setting:** This will allow you to change the vibrating motor speed range. The actual speed range represents 1 to 100%.

⚠️ **Important: This must be set when an un-profiled preset is selected. See Vibrator Speed Settings procedure.**

Creating a new pre-set

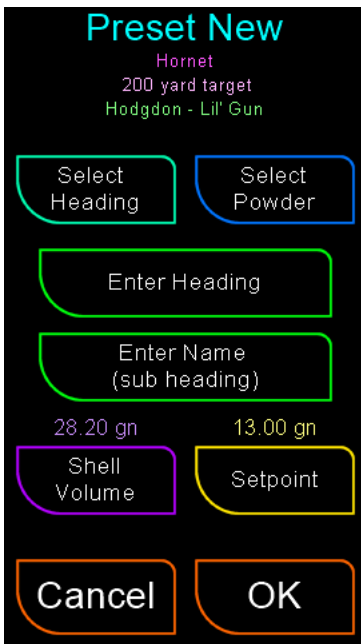

There are several fields to populate when starting a new pre-set. Some of these fields can be selected from existing headings or can be created from scratch using the alphanumeric keypad.

💡 NOTE:

1. Heading is prefilled, or enter a new one
2. Charge Name is required (sub heading).
3. A powder brand and type must be selected.
4. The shell (cartridge) volume is optional.
5. Enter the desired Setpoint for the charge

Editing and Deleting a Pre-set

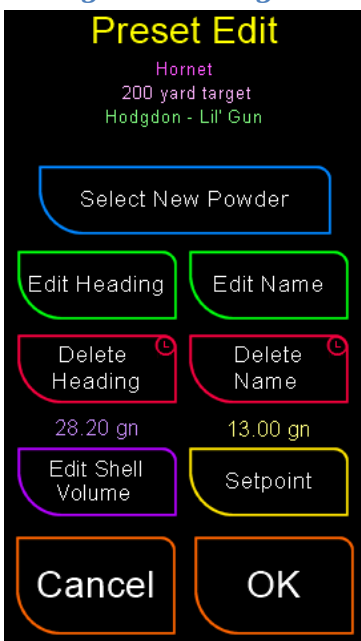

To edit pre-set, select the field that requires changing. When selecting a new powder; if the profile exists for the selected powder that profile's key values will populate the pre-set and if no profile exists then the default profile will be used.

Deleting Presets and Headings

You can delete either an entire heading along with all presets under it or simply remove the currently selected preset by deleting its name.

- To delete a heading and all sub-presets within it, press and hold the ✳️ **Delete Heading** button until you hear a beep.
- To delete only the currently selected preset, press and hold the ✳️ **Delete Name** button until you hear a beep.

Modes

The SuperTrickler has three modes of operation.

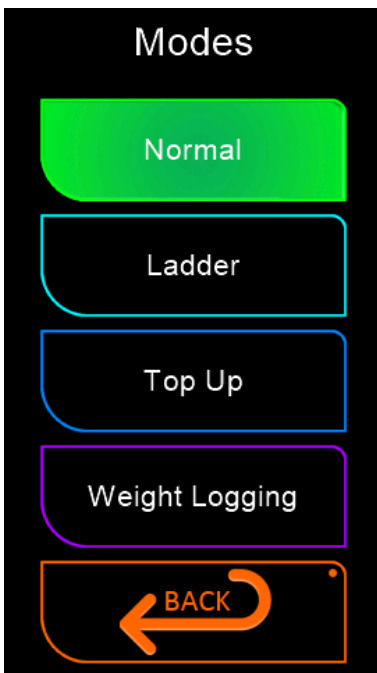

- ✦ **Normal:** this is the standard operational mode.
- ✦ **Ladder:** this mode will generate a ladder of charges.
- ✦ **Top Up:** used if the SuperTrickler is used to only complete a charge rather than dispense the entire charge.
- ✦ **Weight Logging:** used to log weight of objects. Examples are to weigh and sort brass, bullets, primers etc.

Both Ladder and Top Up require additional information and settings for that mode. When either of these two modes are in operation, the Dispensing Screen will display a mode setting (see the Dispensing Screen above item 6.). In the case of Top Up mode, the indication will flash, highlighting the caution needed in this mode.

Ladder Mode Setup

Ladder Mode is designed for ladder testing, which is making a range of loads to find the specific charge that is most accurate. The system is designed to be flexible, when entering any value into the green fields the SuperTrickler will calculate the other green field values, based upon the number of steps entered in the blue field. All green fields are rounded down to a resolution equivalent to the scale resolution (0.02 gr).

There are five parameters required for a ladder test.

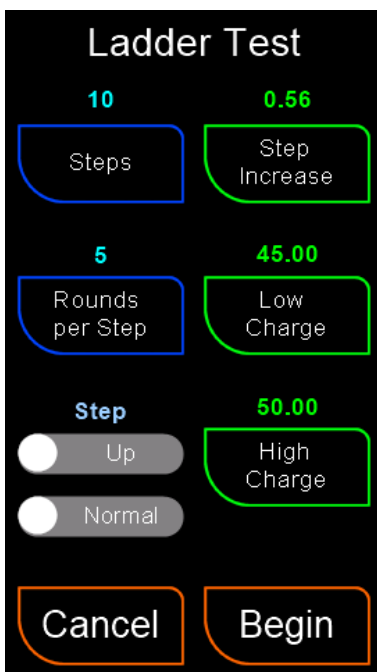

- ✦ **Steps** (top blue): The Number of ladder Steps (changes in charge set point).
- ✦ **Rounds per Step** (mid blue): how many charges are dropped at the steps weight.
- ✦ **Step Increase** (top green): The weight increase per step.
- ✦ **Low Charge** (mid green): The lowest weight in the ladder.
- ✦ **High Charge** (bottom green): The highest weight in the ladder.

After entering the number of steps, it is common to first enter the Step Increase and then the End Charge value, being the theoretical maximum charge weight; letting the system work backwards and calculate out the Start Charge value, however values can be entered in any order and the system will continually calculate out the remaining fields.

Step Options: The first is **Up/Down**, this dictates the if the charge will start at the lowest value and work up or start and the highest value and work down.

The second option is **Normal/Pause:** Pause will pause at the completion of each step (weight change). You will need to press Start to continue on to the next step.

Once you are satisfied with the ladder parameters, pressing “Begin” will take you directly to the Dispensing Screen, ready to begin.

Warning: Check that **all** the green fields are within the specifications you require before beginning the ladder operation.

Ladder Mode Operation

When in ladder mode the dispensing screen will display two pink buttons, Repeat Last Charge and Skip.

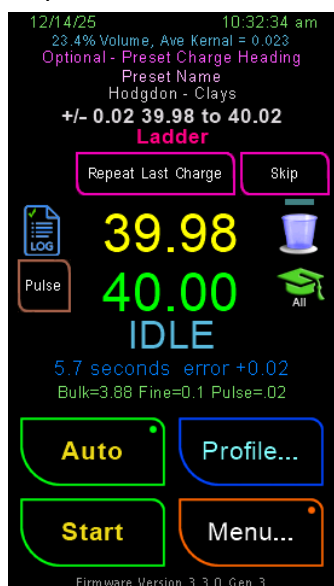

The Repeat button prevents the ladder from moving to the next charge/stage, thus repeating the last charge. This can be used if for some reason the operator is unhappy with the charge or the charge cannot be used for some other reason, e.g. spills.

The Skip button is used to skip the next pending charge. To save time, some users prefer to see if the overthrow can be utilized elsewhere in the laddering range and if so they then place the charge in that position. Later when the SuperTrickler laddering stage gets to a spot that has already been utilized the skip can be pressed to jump over that point.

Top Up Mode

The top up mode was requested by some users, where they only want the SuperTrickler to make the final accurate charge.

Warning: You cannot use multiple powder cups in this mode.



There is one parameter and one measurement required. The charge target set point must be entered. This is the value to which the SuperTrickler will top up the charge. The other is measurement of the empty powder cup weight. Once the cup weight has been measured, the “Begin” button will be enabled, allowing you to then press “Begin”, then taking you directly to the Dispensing Screen to start the process.

Note: Under normal operation the scale is zeroed at the start of each charge to maintain the best possible accuracy. However, in this mode this is not possible. It is recommended to periodically reselect the top up mode and remeasure the cup weight.

Weight Logging Mode

Weight logging is designed for recording a series of weights for objects such as brass cases or bullets. The screen shows weights, counts and allows for setting some groups and other values. These are recorded to a file on the SD card named weight.csv in the \log folder.

Typical for reloaders, 'batches', Groups, or 'Boxes' of cases are weighed. You might have 3 boxes of 50 rounds of brass to weigh. You can use the Up/Down arrows to set the "Group" setting number. This Group X gets recorded in the file on each line. The larger counter is the total number of objects weighed, while the smaller one under the group name is the count in THIS group. It will reset if you press the Up/Down arrow to change the group name. (So you can record case #X in Group #Y, and also keep a total count.).

You have two different modes, direct weight, or including an offset/reference weight to deduct. If the Use Cup button is off, the actual weight of the object is shown/recorded. IF Use Cup is ON, then the system will ask you to put the reference 'cup' on, and it will subtract that reference from each weight recorded. This is used to weigh small objects, maybe bullets, or primers that would otherwise be hard to put on/off the platen of the Scales.

Make sure to press the Close button before removing the SD card.

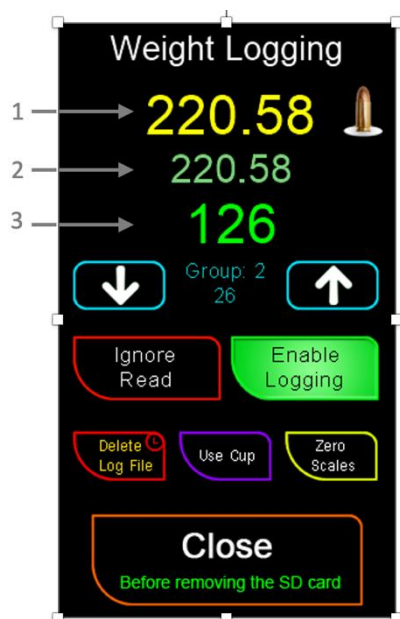

- 1) Current Scales reading
- 2) Recorded weight
- 3) Total Item Count

✳ **Arrows** are to increase/decrease the Group number. Display shows Group Number and Count within that group. The group count resets when you change the group number.

Use the ✳ **Ignore Read** button to throw away the current value and not record in the file.

✳ **Enable Logging** toggles the logging on and off

Press and Hold the ✳ **Delete button** to delete the log file

✳ **Use Cup**: Press this button to create an 'offset' for the cup. It will guide you through the procedure to use the cup.

✳ **Zero Scale**: Allows you to zero the scale.

✳ **Close**: End this session and record the final value in the log file.

💡 **IMPORTANT NOTE: YOU MUST use the Close button BEFORE removing the MicroSD card to record and close the log file! Not doing this could result in losing values in the log.**

Empty Hopper

Use this button to temporarily 'lock' the screen from accidental button pushes and dispensing while emptying the SuperTrickler. The screen below will show, Press and hold for 3 seconds to return to normal operation. This is used to prevent accidentally pressing any buttons while emptying the hopper, and causing powder spillage.

 **Note:** For convenience, the currently loaded powder is also displayed on this screen.

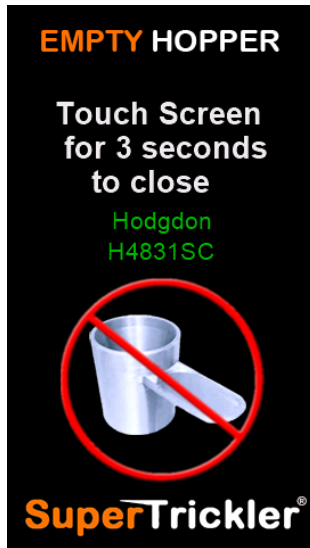

User Notes...

Operational

The operational part of the system is the Tools & Settings menu, where options and functions that may be required in the general operation of the SuperTrickler can be found.

Tools & Settings Menu

The Tools & Settings menu is the starting point of the many mainstream operational functionalities.

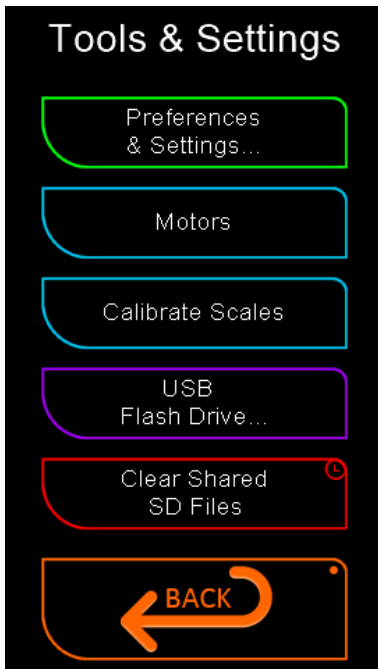

✳ **Preferences & Settings...**: will take you to the many mainstream Preferences and Settings.

✳ **Motors**: allows you to prime, purge, test, flow test and change the bulk trickler tube.

✳ **Calibrate Scales**: use the SuperTrickler interface to calibrate the scale.

✳ **USB Flash Drive**: Gen 3 machines only, take you to the USB flash drive file transfer menus.

✳ **Clear Shared SD Files**: Press and hold to delete all profile and preset sharable text files located in the SD card's shared folder.

Preferences & Settings



✳ **Preferences**: will take you to the many options, such as: display brightness, start-up options, dispensing screen, times, audio options, work light options and external control.

✳ **Statistics**: will take you to a screen that displays system metrics etc. Important information included is the 'Current Powder Used'. This is reset whenever the powder is changed.

✳ **Data Logging**: Go to the settings for [Data logging](#).

✳ **Automatic power up times**: is an easy system to quickly setup automatic power up times, allowing the SuperTrickler to be warmed up and ready when you are.

Preferences

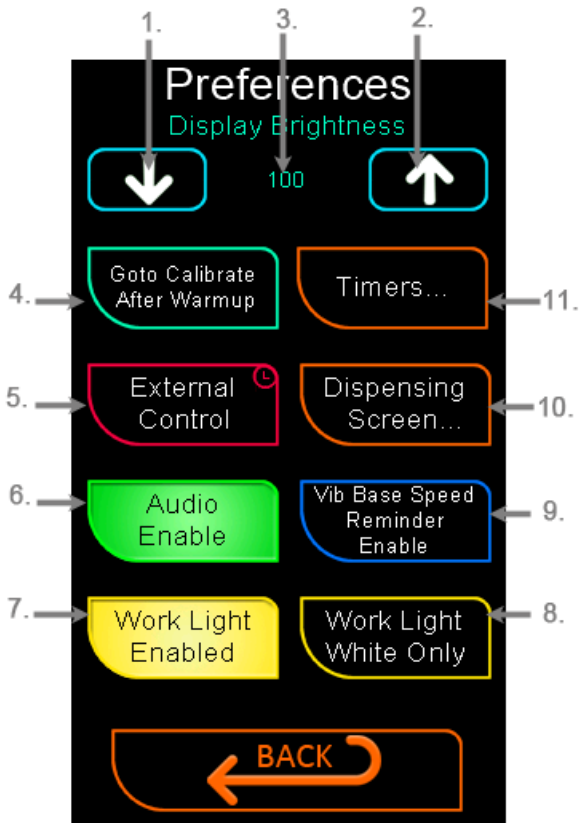

- ✳ Display brightness – dimmer.
- ✳ Display brightness – brighter.
- Display brightness value.
- ✳ Enable/Disables SuperTrickler to automatically go to the calibration screen once the system is warmed up and ready. We highly recommend regular calibration, and this system makes it easy.
- ✳ Enable/Disable external control (Flashes when enabled, needs to be held down to change)
- ✳ Enable/Disable audio sounds.
- ✳ Enable/Disable the work light.
- ✳ Disables the use of colors with the work light.
- ✳ Vibrator Base Speed Reminders Enable. To disable the reminders turn this off.
- ✳ Dispensing Screen Options.
- ✳ Timers submenu enables you to setup warm up times, power down, sleep times and the Vibrator Base speed Idle reminder time.

Timer Option

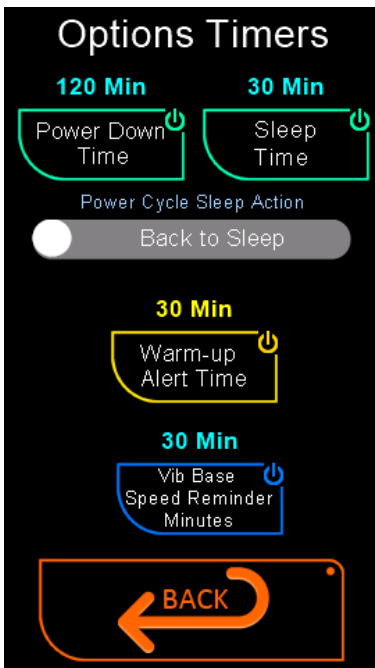

✳ **Power Down Time:** (in minutes) after this time, when no activity is detected, or the system is sleeping, the system will power down. It will turn off the power to the scale and puts the SuperTrickler into hibernation. To reactivate, touch the screen. Press and hold to disable this function.

✳ **Sleep Time:** (in minutes) after this time, when no activity is detected, the system will go into sleep, turning off the scales display only and puts the SuperTrickler into hibernation. To reactivate, touch the screen. Press and hold to disable this function.

✳ **Power Cycle Sleep Action:** Back to Sleep/Stay Awake, this option dictates what happens if the SuperTrickler is sleeping or powered down (deep sleep) and the main power is cycled. The Setting will tell the SuperTrickler to either go back to sleep or power down as it was, alternatively it will stay awake as though it had just been woken up.

✳ **Warm-up Alert Time:** (in minutes) when powered up, the system will wait until this time, then turn on an audible alarm and display a ready alert screen. Press and hold to disable this function.

Vib Base Speed Reminder Minutes: If the *Vibrator Base Speed Reminders Enable* button is active and this timer is set to a value greater than zero, a reminder will be issued if dispensing remains idle for longer than the specified duration. The reminder will appear before dispensing resumes. Press and hold to disable this function.

Dispensing Screen Options

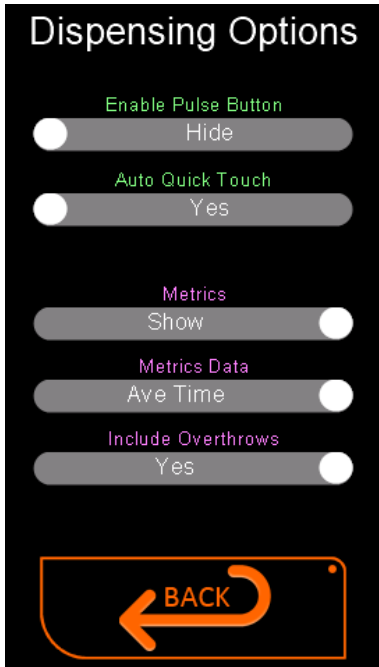

- ✳ **Enable Pulse Button:** Hide/Show – use this to enable the manual pulse button on the dispensing screen.
- ✳ **Auto Quick Touch:** Yes/No – When ON, will allow a quick touch of the manual Pulse button, to automatically run the pulse cycle until the scales detect a change in weight. Holding the button longer will initiate a single pulse. If set to NO, then touching or holding the button will initiate a single pulse.
- ✳ **Metrics:** Hide/Show - Control the statistical data that is shown on the dispensing screen.
- ✳ **Metrics Data:** Success Count/Ave Time – either show the success information or the average time information.
- ✳ **Include Overthrows:** No/Yes – controls if an overthrows time is included in the average time.

Statistics

Displays various statistics about your SuperTrickler such as Charges, Run-times, Powder Usage & Loaded Count.



In general, most the information on the screen is self-explanatory, however the Current Powder Used and Profile Loaded Count are less obvious.

The **Current Powder Used**, shows the amount of powder used since the powder type has been changed from either directly choosing a different powder or selecting a profile with a different powder.

The **Profile Loaded Count** will show the number of successful charges made from this profile. At any time you may edit this (✳ **Edit Loaded**) value to any value desired. This can be helpful in managing and counting load batches.

Data Logging

The data logging ability of the SuperTrickler is an important feature. There are two main log files stored on the micro-SD card. The log file size is limited to 3.9 gigabytes (4294967295 bytes), an enormous amount of data. For more detailed information see the "[Charge Log Files](#)" later in this document.

There are two separate log files; one for successful charges (loads.csv) and the other for analysis or failed charges (analysis.csv). The analysis file logs failed loads and contains all the same fields as the successful loads, with additional information that can be used by our support team to analyse the reasons why the failed load occurred. When you first open the logging options page an hourglass will appear while the system reads the file sizes and free space.

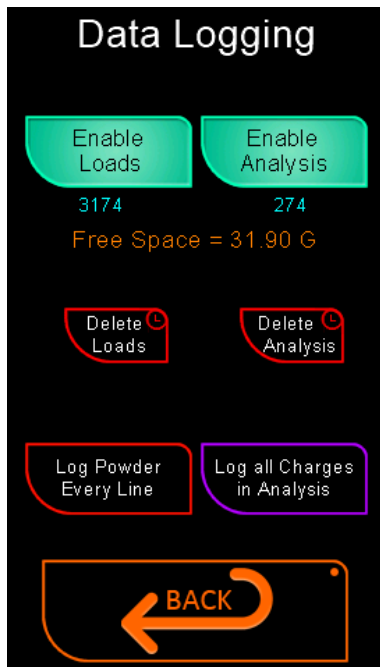

Once open, you can turn on or off either of the log files; however, it is highly recommended to always leave the Analysis log file running. The button will be highlighted when ON.

Holding the ⚡ **Delete** buttons will delete the existing file and recreate a new file.

⚡ **Log Powder Every Line:** toggles between logging modes, that will place the powder and or preset in every line. See the *Charge Log File* section for details.

⚡ **Log all Charges in Analysis:** toggles between logging modes, when this is on, every charge good or bad will be logged in the Analysis file. See the *Charge Log File* section for details

Automatic power up times Menu, Submenus, Tools & Settings, Preferences & Settings

Automatic power up times enables you to have a preset time for a given day when you would like your SuperTrickler to be warmed up and ready. The SuperTrickler will take into consideration the warm-up time if set in the options “options ▶ times ▶ Warm-up Alert Time”

NOTE: The SuperTrickler will wake from a sleep or power down state should it be in that mode when the wake-up call is initiated.

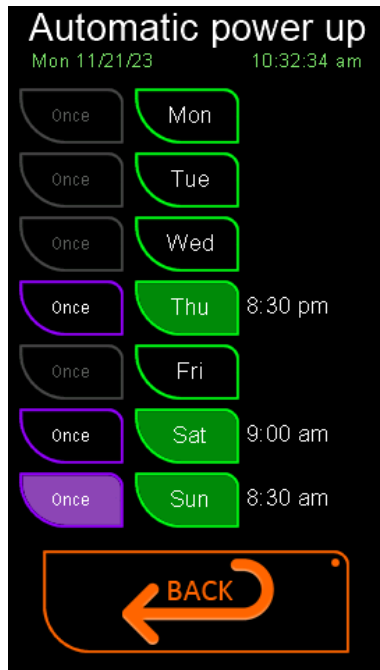

To set a time:

Press the day button, then on the keypad enter the time the SuperTrickler is to be ready, then press OK.

The time will be displayed on the screen, indicating its activity. This will repeat on this day until you disable it. Enabled days will be green.

To disable time:

Simply press the day button that you require to be disabled.

To re-enable a time:

Press the day button and the previous time used will be automatically added to the keypad. You can either change this time or simply press OK to accept the previous time.

Pressing the ‘Once’ button will allow the set wake up to happen just once (not repeat weekly).

This screen is for common motor function and testing to establish motor speeds and powder flows.

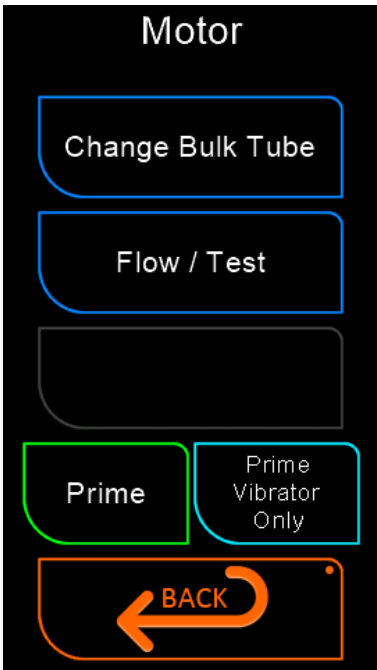

- ✳ **Change Bulk Tube:** takes you to a menu that assists in the removal and installation of the bulk trickler tube.
- ✳ **Flow / Test:** will take you to the motor’s flow and testing screen.
- ✳ **Prime:** Primes both tubes for 6 seconds
- ✳ **Prime Vibrator Only:** will prime only the vibrator tube for 45 seconds.

You can stop the priming process at any time by pressing the priming button again.

Each priming button will also issue a warning to check a cup is in place before starting the prime, you can shortcut the delay by touching the red warning panel.

Change Bulk Tube

This functionality is designed to assist you in removing and installing the bulk trickler tube.

⚠ Warning: Do not remove the bulk trickler tube with powder in the hopper. Doing so will allow powder into the body of the unit and will require cleaning from an authorised service center, at your cost.

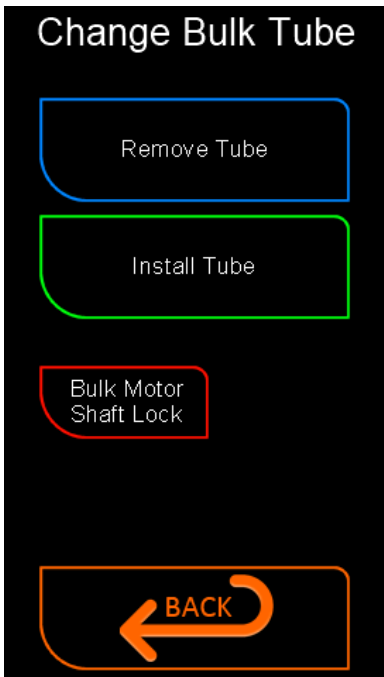

- ✳ **Remove Tube:** will run the motor in reverse for around 10 seconds. By holding the end of the bulk tube during this time, the tube should easily unscrew itself.
- ✳ **Install Tube:** will run the motor in forward for around 10 seconds. Holding the end of the bulk tube, place it against the threaded motor shaft and allow it to screw on, until the motor stalls, then release the tube. Be careful to not cross thread the tube.
- ✳ **Bulk Motor Shaft Lock:** will lock the bulk motor’s shaft for 10 seconds, to assist in the removal of the bulk trickler tube, in the event the above methods are unsuccessful.

💡 Note: If you exit this screen without re-installing the bulk tube, the red working like will flash continuously on all screens.

Motor Testing

This functionality is designed to test motor speeds and flows for best performance with a given powder and when manual profile alterations are required.

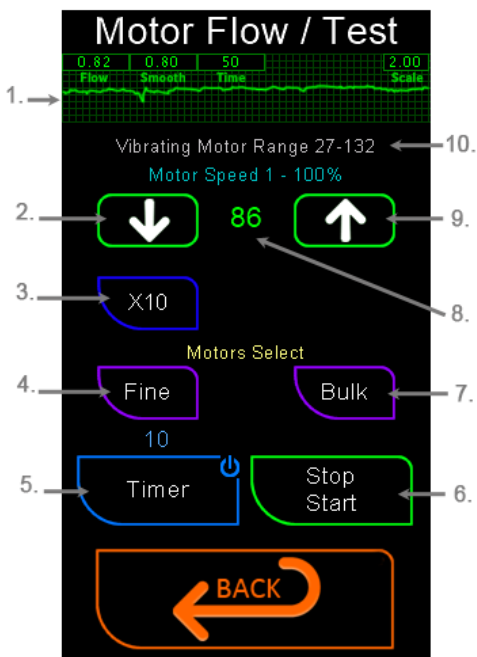

1. See the section on the [Powder Flow Graph](#).
2. ⚙ Speed DOWN 1 or 10 units (hold to repeat)
3. ⚙ x 1 or x 10 units per arrow press
4. ⚙ Enable fine motor
5. ⚙ Sets the run time for test, touch and hold to disable.
6. ⚙ Start/Stop selected motors.
7. ⚙ Enable bulk motor
8. Current motor speed %
9. ⚙ Speed UP 1 or 10 units (hold to repeat)
10. Current vibrator motor speed range settings

Calibrate Scales *Menu, Submenus, Tools & Settings*

The SuperTrickler scale calibration is just an easy interface into the standard calibration system. The process takes you through the calibration procedure in steps

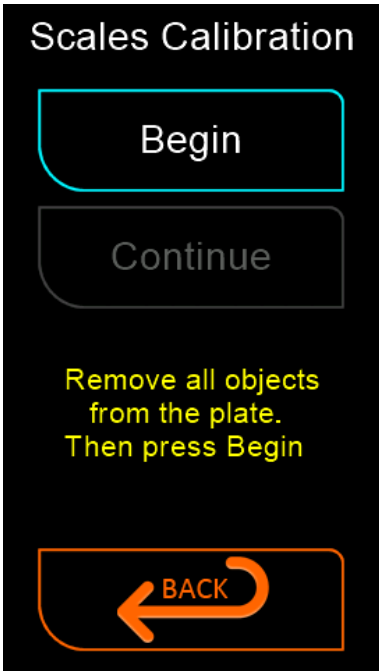

NOTE: You will need a precision standard 50 or 100 gram weight if you have an FX series scale. It is highly recommended that you never touch your calibration with your bare hands, as your skin oils can change and damage the weight.

Once you have entered the calibration page, it is simply a matter of following the instructions as they appear.

Scale Calibration Weight

The A&D FX-120i scale can be calibrated with either a 50 gram or 100 gram precision standard weight. The default is for a 100 gram weight, and that is what is recommended. Should you require using a 50 gram weight, see below.

To set the scale for a 50 gram precision standard weight. With the scale running and ON.

Steps	Button	Instruction	Display	Information
1		Press Cal for 2 seconds	cal	Calibration
2		Press SAMPLE	100000	100 gram weight
3		Press Mode	50000	50 gram weight
4		Press PRINT	cal	Save change
5		Press Cal		Exit calibration change

Note: Repeat the steps to change back to 100 grams calibration if required at any time.

System

The system section of the SuperTrickler contains all the non-mainstream functionality, deep settings, configuration, factory restores, upgrade and testing facilities.

System Menu

The system menu is the gateway to the many system settings, configuration and diagnostics.

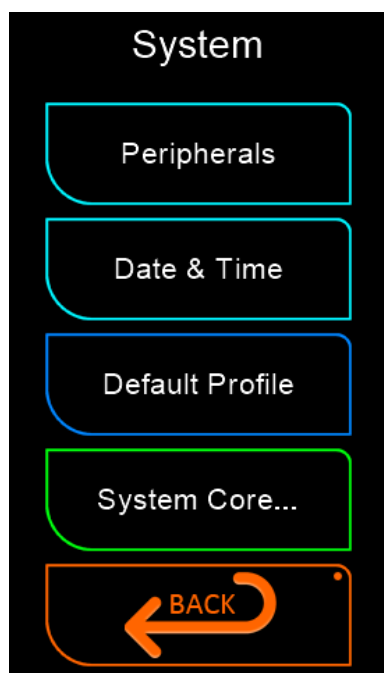

✳ **Peripherals...**: are the sub devices attached to the SuperTrickler. These are the micro-SD card device, the scale, and the powder cup laser sensor.

✳ **Date & Time...**: to set the current date and time. This functionality includes the date, time formats and daylight savings switch.

✳ **Default Profile:** is the profile used when no other previous profile can be found for a given powder.

✳ **System Core** is the defaults and rarely used setting, firmware updates, factory restore functionality and self testing.

Peripherals

The system peripherals are devices integral to the standard operation of the SuperTrickler.

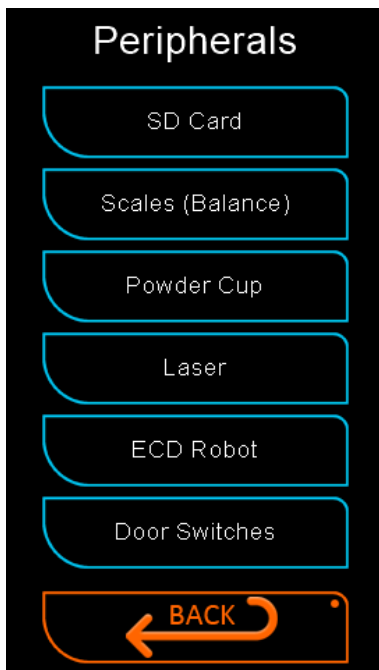

✳ **SD card:** will give information about the installed micro-SD card, formatting and recreating the data structure can also be performed from this page.

✳ **Scales (Balance):** allows you to diagnose the data stream from the scale and to configure the operation settings. Scale calibration is also available from this screen.

✳ **Powder Cup:** is the setup that controls the powder cup monitoring using the scale.

✳ **Laser:** is an optional laser, that will monitor the cup in addition to the scale weight data. This screen will enable the operator to read the laser operation in real time and to set its operational parameters. This option may not be available if the laser is disabled in the system deep settings. (💡 **Note: This feature is experimental at this time, use with caution.**)

✳ **ECD Robot:** External Control Device used with automation systems or robotic units such as the SuperFiller. Selecting this option will take you to a testing and monitoring screen, which is not documented within this owner's manual.

✳ **Door Switches:** This is a Generation 3 feature, described in detail within the *Generation 3* section near the end of this document.

SD Card

The SD card contains log files and the database for powder profiles and custom pre-set profiles, along with several other system files.

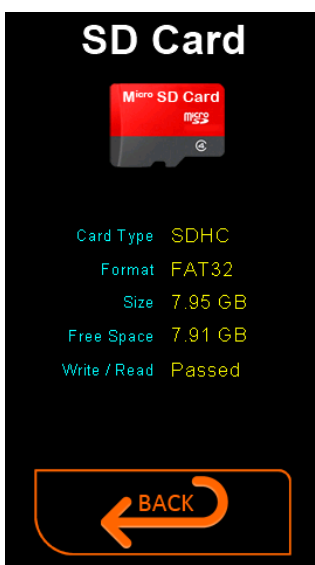

When you first open this page the SD card details will be displayed, however the free space and Write / Read test will take a few seconds to display.

💡 **Note:** The Free Space is displayed as Gigabytes (GB) when its above 1 GB and below this the value will be displayed in Kilobytes (KB).

Formatting the SD card.

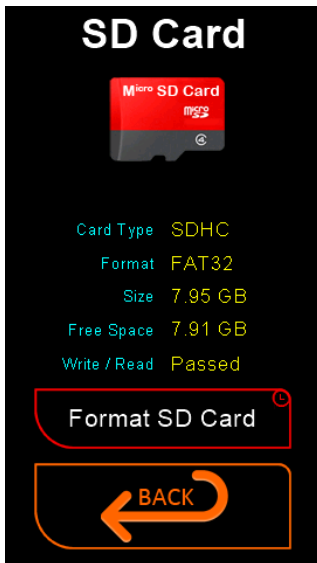

It is critical that you use the SuperTrickler formatting function and not use a card formatted by a personal computer. Often personal computers will not use a fully  **SD Association** compliant format. The card might work in general but may not support the firmware update functionality that is card-format critical.

⚠ Warning: all data, log information and system support information will be lost when formatting. Should you wish to keep all your data and just upgrade or replace the card you can simply copy all the data on the old SD card into a personal computer, then format the new card using the SuperTrickler. After the formatting has completed, simply copy the data back onto the newly formatted card. The format function will automatically add some system files and folders and you can overwrite these with the old data.

How to invoke the format function.

The format function is not immediately available to the operator; this is to prevent accidental formatting.

Step 1. ✨ Press and hold the Micro-SD card picture for 2 seconds (after the Write/Read test has completed) *this will enable the Format SD Card button.*

Step 2. ✨ Press and hold the 'Format SD Card' button for 2 seconds and the format will begin.

An hourglass ⌚ will be displayed during formatting and the screen will be refreshed when finished.

⚠ Warning: Removing the card or the loss of power during the formatting process may destroy the card.

Scales (Balance)

It is common to use the term scale or scales in place of balance. They are technically different however for the sake of clarity 'scale' has a more intuitive annotation.

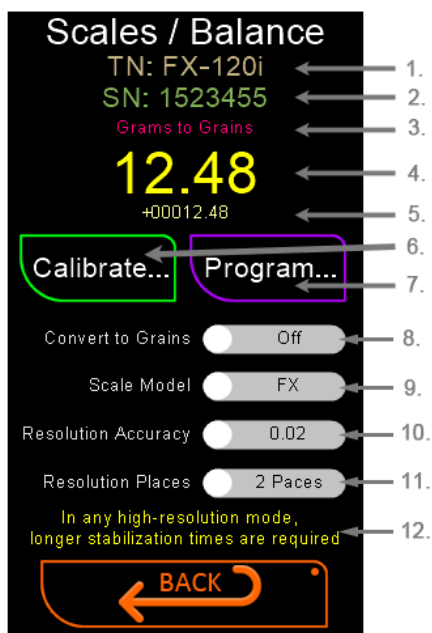

1. A&D model type number.
2. A&D serial number.
3. Shows if the display has been converted from Grams to Grains (see button 8 just below).
4. The scale value.
5. The data stream sent from the scale to the SuperTrickler. This can be critical information when trying to diagnose a communications error.
6. ✳ This will re-zero the scale.
7. ✳ This button takes you to the scales programming page. For details on how to program the scales, please see the installation manual.
8. ✳ As some A&D models only work in Metric Grams, turning this on will convert the weight from the scale into Grains.

9. ✳ Toggle FZ Calibration mode on/off (should be auto selected if you have an FZ series scale.) If the system detects the FZ type then this option will be automatically turned on.

10. ✳ This button selects on the resolution accuracy and allows selection of 0.01 rather than the standard 0.02 grains. Warning: Do not set this to 0.01 unless your scale supports 0.01 or 0.001 resolution.

11. ✳ This button selects the support two or three decimal place resolution. Do not turn this on unless the scales support and is set for three decimal resolutions.

12. ⚠ Warning: A&D FX/FZ 104 and FX/FZ 254 High-Resolution Balances

When using these high-resolution scales, both resolution accuracy and decimal places settings must be configured appropriately. Additionally, these models require longer stabilization times to achieve an accurate weight.

As a result:

- You will need to increase Final and other **stabilization times**
- **Pulse durations** might also require adjustment for optimal performance

✂ Fine-tuning these settings ensures reliable dispensing and accurate measurements at higher precision.

⚠ Recommendation:

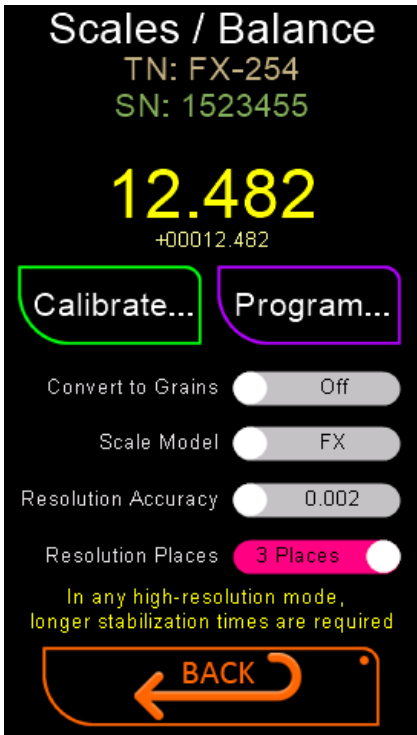

After enabling any high-resolution option, it is recommended that you navigate to **System > System Core > Restore > Profile**, and restore the default profile. This will help ensure that many of the initial settings are correctly applied.

💡 Note:

Do not select a resolution beyond the scale's capabilities. These settings are intended to *match* the scale's configured resolution—they do **not** define or override it. Selecting an unsupported resolution may result in inaccurate readings, communication errors and will generally yield a **X Error** warning.

⚠ Scale Error Codes

When detected, error codes are reported in the standard weight value field. Each code indicates a specific protocol or data integrity issue during communication with the scale:

- **-E, Generic:** is a generic error indicator shown when the scale cannot stabilize or process a valid weight reading. It often appears when:
 - The weighing environment is unstable (vibration, drafts, temperature fluctuations, static, or magnetic interference).
 - The tare or calibration process fails.
 - The load cell is overloaded or the platen is obstructed.
 - The scale is powered on with a load already on the pan.First try removing the cup and re-zeroing the scale, or power-cycle the scale with the cup removed from the platen, or perform a full calibration to reestablish correct framing.
- **T-Error, Timeout:** The scale failed to transmit a complete data packet within the expected time window. This may indicate a communication delay, disconnection, or hardware fault.
- **D-Error, Data Length Mismatch:** The received data packet length does not conform to the expected byte count defined by the current scale configuration. This maybe associated with a generic -E error displayed on the scale.
- **X-Error, Unexpected Format:** The data stream contains values or structure inconsistent with the configured scale settings. Ensure the scale settings are matching the scale type and configuration.
- **R-Error, Out-of-Range Value:** The parsed weight value falls outside the valid operational range defined by the system. This could indicate a corrupted packet, sensor fault, or miscalibration.

Incorrect scale speed setting

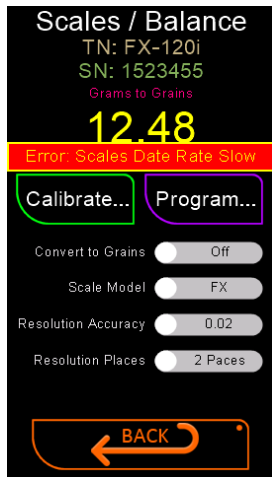

In the event you see “Error: Scales Date Rate Slow”, revisit the scale settings: Base Functions, Display Refresh Rate and ensure its set to 20 times/second.

Configured Scales Not Found

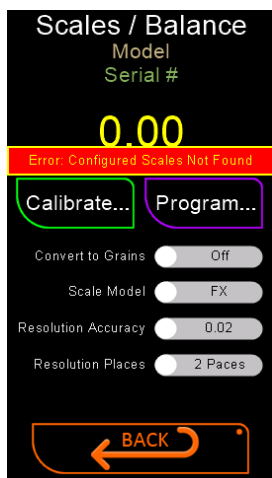

This message will be shown when the scale is not found or is not programmed with the correct configuration. To resolve this issue, press the Program button. See the Installation manual for more details on programming the scale..

Programming the Scale

This is an automated process that will, with minimal intervention, program the scales ready for use with the SuperTrickler. This process is not 100% guaranteed to work due to A&D firmware variations.

Supported Scales: FX/FZ-120i, FX/FZ-123, FX/FZ-300i, FX/FZ-104, FX/FZ-254



⚠ **Check Status:** This will initiate a communication inquiry to the scale to determine the current state of the scale (if found). Upon entry to this screen, a preliminary examination is made; this option will initiate a more comprehensive check.

⚠ **Reset Guide:** This will guide the user through the steps to restore the scales' factory configuration and settings.

⚠ **Program:** This will guide the user through the step that puts the scale into ready-to-program mode, then allows them to initiate the automated programming process.

💡 **Note:** This button is normally grayed out and only becomes enabled when the "Required Programming" status is detected.

Status description & Icon displays



Not Found: The scale was not found or could not be read. Check the cable between the SuperTrickler and the scale.



Status Check: The system is asking you to press the Check Status button again, as the current information is unclear.



Please Reset: The system can read the scale and has found that a reset is required for the configuration to be compatible with the SuperTrickler. Press the Reset Guide... for instructions.

 **Special Note:** If your scale does not support Grains (GN) as a unit of weight, this message will appear even after programming. Manual setting of at least the units will be required, as the programming process may have corrupted the unit settings.



Required Programming: The system has found that the scale is now ready for programming, and the Program... button will be enabled — ready to start the process. (See below for more details.)



Programmed & Ready: The system has queried the scale and found that it appears ready for use with the SuperTrickler.



OK but Grams only: The system found the programming correct; however, it cannot set the weight units to GN (grains). (This may be possible with manual settings.)
The "Convert Grams to Grains" switch will be turned on, and it should be OK to run on the SuperTrickler.

Programming Screen

Initial Screen: This instructs the user how to set the scale into a mode ready for programming by holding the Sample button on the scale for 2 seconds. Once this has been completed and the scale reads bASFnC, pressing the Done (bASFnC) button will start the programming process.



Once programming has started, the screen will display "Program" and a progress bar during the programming cycle.

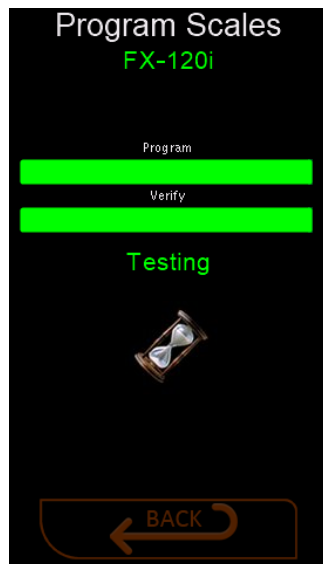

It will then display "Verify" and a progress bar during this cycle.

Finally, it will display "Testing" when the scale is power-cycled and tested to confirm that programming has been successful.

Upon completion of the testing, the system will return you to the main Program Scales status screen.

The Next Step



The screen should now be displaying "**Programmed & Ready.**" Or "**OK but Grams only**" so its time to go back to the Scales/Balance screen and set the SuperTrickler configuration to suit the scale and settings.

You can skip the next section (**Manual Programming of the Scale**) and jump down to the "**Scale Communications and Matching Configuration**" section below.

Oh No, something is wrong.

If, for some reason, the scale will not program correctly or the status display does not allow the Program button to be enabled, then you may have an unsupported scale or unsupported scale firmware. In this case, you will have to manually program the scale. See instructions below.

Powder Cup Scales Monitoring

The Powder Cup Setup uses the scale to read the weight to determine the status of the powder cup.



✦ **Off weight:** this will be a negative value well below zero where the cup would be considered as removed or “Not on the scale”

✦ **On weight range min:** this will be a negative value just below zero where an empty cup would be considered close enough to “Empty on the scales”.

✦ **On weight range max:** this will be a positive value just above zero where an empty cup would be considered close enough to “Empty on the scales”.

✦ **EDC weight range max:** External Control Device weight max. This is identical to the On Weight Range Max; however, this value is used rather than the On Weight Max when the external device is in use. This value should be set high enough to allow a small amount of scale drift. When the cup is returned by the ECD, the weight is measured. In the event the cup weight is larger than this value, a Dangerous Error signal will be sent to the ECD, and the last filled cartridge will be flagged as faulty. The ECD will take the cup, discard its contents, then return the cup to continue the charging and filling

operation.

✦ **Ready Delay** this is a time in milliseconds that allows the scale to stabilise after an empty cup has been put back on the scale. If this time is too short, you may be zeroing the scale before they are stable, generating an error and possible incorrect charge.

✦ **Restore** Hold this button in for about 2 seconds to restore the factory settings, which is identical to restoring the default profile from the system restore options.

Powder Cup Laser Sensor

The SuperTrickler is equipped with a laser sensor to detect the cup. This functionality is optional (enable/disable) and can help prevent starting a charge without the powder cup in position. This system is used, in conjunction with the powder cup monitoring system, to ascertain the status of the powder cup. Other systems on the market generally just use the weight on the scale to determine this and prevent starts without the cup in position. However, with this comes a serious compromise, in that the scale is not re-zeroed before each charge and only allows the use of one powder cup or cups that are precisely the same weight. The laser helps to overcome this issue and several cups can be used without any consideration to weight. It is recommended the same cup design be used to allow the laser to detect the same dynamics.

The program will display an oscilloscope-type wave form of the laser distance as a visual guide, along with the cup status picture as detected by the laser and the laser distance reading. There are 3 settings that need to be set to configure the laser, if enabled:



✳ **Enable Monitoring:** Enables the laser system. This will add an additional safeguard against an accidental charge without the cup in the correct position. There is no compromise on accuracy doing this as the SuperTrickler will still perform a zero at the beginning of each charge.

✳ **No Cup:** is the distance when no powder cup is present.

✳ **Empty Cup:** is the distance when the powder cup is present and empty.

✳ **Full Cup:** is the distance when the powder cup is present and full of material. To calibrate this setting turn the power cup side down on the platen.

✳ **Smoothing:** Adjust laser filter sampling to smooth the curve/readings. The laser beam is subject to noise and stray reflections etc resulting in an unstable reading. The smoothing control is used to filter out the noise to obtain a usefull distance measurment. Too little smoothing and the distance measurment will be unstable and unreliable. Too much smoothing and the distance measurement will be slow to react and may interfere with the smooth flow of the powder cup detection and charging operations. A value of around 98.0 is about right however if it does required changing, try very small adjustments a value of 1.0 is a large change.

To set the No Cup and Empty Cup, place the cup either on or off the scale plate and allow a small amount of settling time then set the value a few mm lower than the reading (this keypad will default to this value).

💡 **Note:** The entire laser system can be disabled in the Deep System Setup menu.

Date & Time

The SuperTrickler has a built-in Real Time Clock, tracking the time and date. The format of the date can be selected to suit your country's standards and preference for 12- or 24-hour time format.

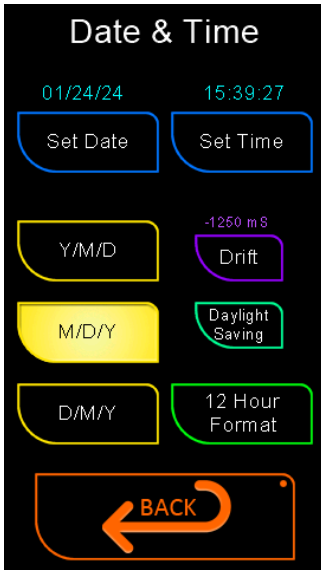

When selecting, the keypad will automatically format the time or date for you, so it is important to first select the date and time format preferred and daylight saving (on or off) before setting the time and date.

Daylight Saving does not automatically put the system into daylight savings tracking, rather it is a convenient way to subtract an hour (DLS on) or add an hour (DLS off) to the current time.

Note: Real Time Clocks are subject to drift. To keep your log file record times accurate, it is recommended to check the time regularly with a known accurate time source and adjust the time accordingly. If you find that the clock drifts, you can use the 'Drift' button to apply a correction. The value shown is the 'drift' observed over 1 day (24hours). Here is an example of how to use it. Say you set your clock at 21:21:21 on 11/23, and at 22:22:22 on 11/25 you see the clock is behind by 20s from a trusted clock. Calculate the number of days and divide 20s by that. (The example is $2d+1h+1m+1s$, $2*24*60*60+1*60*60+1*60+1$ (convert everything to seconds) that's 176,461s. Now to days is $(84,600s/day)$ $176,461/84,600=2.0858days$. So, then $20s/2.0858d = 9.588s/d$. To correct for the drift, set the drift to +9588. That will add 9.588s per day to the clock.

Of course, you could also just keep resetting the correct time on the clock via the keypad when it drifts more than you like!

Default Profile

This selection allows you to configure the default settings that will apply to all future profiles. If a powder is not recognized, this default profile will be used to provide basic settings. Additionally, when resetting a profile, these defaults will serve as the basis for instrument configuration and other settings, depending on the reset option selected.

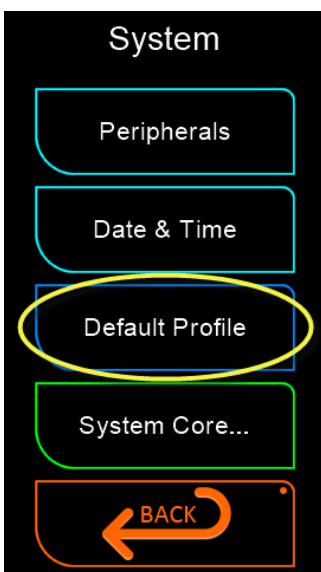

Default profile in relation to the High Speed Max Run Time & Default Base Speed Offset

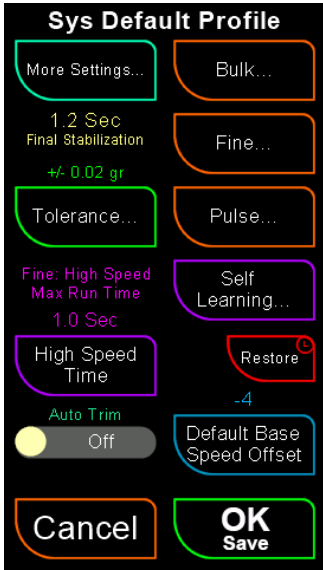

✳ **High Speed Max Run Time**

As there is no room on the Fine screen for this control, the ability to change its default value will be available in the Default Profile settings.

✳ **Default Base Speed Offset & Auto Trim**

These settings are available in the Default Profile settings main screen, as its usual location under the Vibrator Base Speed settings is not accessible when using the Default Profile.

✳ **Restore**

This is identical to restoring the default profile from the system restore options. With the introduction of high-resolution scales, when changing the scale setting, it is highly advisable to also restore the default profile, as this will take the currently selected scale into consideration. To restore the default profile, press and hold the Restore button for about 2 seconds..

System Core

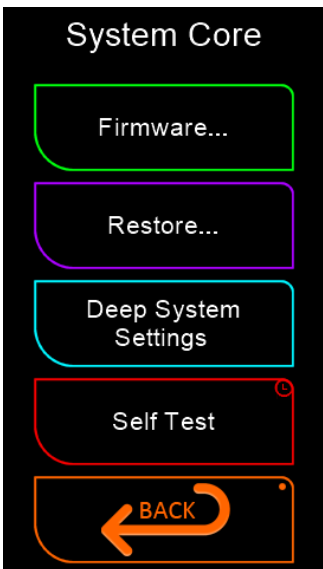

✳ **Firmware:** when the system detects a new firmware update on the SD card, it will automatically take you to this page. You may wish to simply exit the page and do the update at a later time.

💡 **NOTE:** In some circumstances, an update may be initiated without intervention (as soon as it's detected).

✳ **Restore:** takes you to a menu that allows you to select a section of the system that you may want to restore to factory defaults.

✳ **Deep System Settings:** These are system-level configurations and defaults that are rarely used under normal operating conditions. **USE WITH CAUTION!**

✳ **Self Test:** will run a self-test program (mostly for use by service technicians).

Firmware Update

Training Video Available: https://youtu.be/hmzxOpM_AYY

DO NOT FORMAT OR DELETE THE CONTENTS OF YOUR SD CARD AS ANY PART OF THE UPGRADE PROCESS.

DO NOT use a different SD card for the update.

The installation process will place essential SuperTrickler files onto the SD card's folders, which must remain consistent for proper functionality.

The firmware update system is a powerful system, where a single update file can be downloaded from the web, copied onto the Micro SD card, and installed on the system. Unlike many other systems you may have encountered, the SuperTrickler update system takes great care to ensure each update file is 100% corruption free. These files are both tamper and corruption checked for many facets before beginning an update. The system can be reversed to previous versions if required.

Upon completion of the update, the updated file will be removed from the Micro SD card. Then naming convention for the file is described in [Appendix A](#).

NOTE:

1. It is highly recommended that the what's new document be studied prior to running an update, as in some circumstances the update will initiate a factory reset of one or more areas of the system.
2. When the system detects a new firmware update on the SD card, it will automatically take you to this page. You may wish to simply to exit the page and do the update at a later time.
3. In some circumstances an update may be initiated without intervention (as soon as it's detected).

Important: Roll Back Strategy

With each version upgrade, as in any complex software system, the results of the upgrade may not yield desirable or beneficial results. You may wish to 'roll back' or return to the previous version where you were having more desirable results. In general, rolling back the software is not an issue; however each version tends to modify your profiles a bit and this can make the roll back annoying, losing your finely tuned profiles. Before upgrading, please follow the directions below to save the current version of your profiles in case you decide to roll back.

TO SAVE YOUR CURRENT VERSION PROFILES BEFORE UPGRADING:

When you take your Micro SD card out to load the upgrade file on it (as described in the Install section below), make a copy of the BIN folder, either on your computer or on the SD card. You can name it anything OTHER than BIN (e.g., BIN220 or BIN310). **DO NOT REMOVE THE ORIGINAL BIN FOLDER.**

Complete your upgrade. If you find you want to roll back, simply rename the existing BIN folder to BIN311 or delete it. Then, rename your BIN220/BIN310 back to BIN, perform the rollback update, and you will be back to your previous state before the upgrade.

Install

1. With the SuperTrickler **powered on** and from the main sub menu, remove the Micro SD card (tweezers are a great help).
2. Copy the .stf file on the root (default folder) directory of the Micro SD card.
3. Reinsert the card back into the SuperTrickler.
4. The system should automatically take you to the Upgrade screen. (System – Setup - System Core – Firmware Update)
5. Press & Hold the Start button for several seconds until the process starts.

⚠ Warning: during an update, the green work light will flash, indicating firmware progress. Green was chosen, as it has the least potential to trigger epilepsy, however, if you are prone to epilepsy, it is recommended to look away during the update. Adequate time will be given with a warning before this process begins. During other parts of the update, the system may flash a purple light at a rate outside the epilepsy sensitivity range.

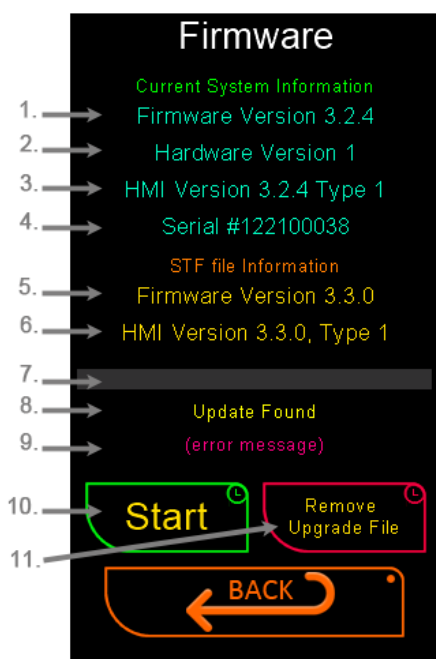

1. Current controller firmware version.
2. Hardware (controller board) version.
3. Current HMI (Human Machine Interface) touchscreen firmware version and hardware type.
4. Machine serial number.
5. The controller update firmware version.
6. The HMI update firmware version.
7. File unpacking and checking progress bar.
8. Status and process information messages.
9. Error message.
10. ✳ Start button; this button must be held in for over a second before the update starts to avoid unintentional execution.
11. ✳ Remove Upgrade File; this button must be held in for over a second before activating. Use it if, after a successful update, the system still thinks the update file is there.

To obtain firmware updates please go to: <https://supertrickler.com.au/firmware>

Update Error codes

Code	Reason	Fix
E0: Undefined Error	This error is caused by undefined reasons and should not occur.	
E1: cannot open file	The .STF file cannot be opened.	Check SD disk format and reinstall the .STF file
E2: unknown format	The .STF file format is an unknown type.	Download & reinstall the .STF file
E3: descriptor size	The part of the file that has the update information is not the correct size.	This may be caused by upgrading from a very early version to a much later version.
E4: descriptor CRC	The descriptor data is corrupt	Download & reinstall the .STF file
E5: retired format	The update file is no longer supported	Download the latest or matching .STF file
E6: not valid file	The file marker STPK is not present	Download & reinstall the .STF file
E7: wrong product	The file is not suitable for your SuperTrickler product code	This is rare and is possibly caused by using a special .STF file
E8: wrong serial	The .STF is not compatible with registered serial number	
E9: CB firmware version	The controller board firmware is not compatible with HMI update.	Download the latest or matching .STF file
E10: HMI firmware version	The HMI version is not compatible with the controller firmware version.	Download the latest or matching .STF file
E11: CB hardware version	The controller board hardware (board type) is not suitable for this controller firmware	
E12: HMI hardware type	The HMI hardware (Display type) is not suitable for the HMI firmware.	
E13: creating CB file	There was a problem creating the file that the controller firmware is unpacked into.	Check SD disk format or disk space
E14: CB write size	The unpacked controller firmware file did not unpack to the correct size.	Check SD disk format or disk space
E15: CB read CRC	The data area of the .STF if corrupt.	Download & reinstall the .SFT file
E16: CB write CRC	The unpacked controller firmware file did not write correctly.	Try again
E17: CB position	The controller part of the .STF file could not be accessed	Download & reinstall the .SFT file
E18: HMI data size	The size of the HMI data in the .STF is not correct	Download & reinstall the .STF file
E19: HMI read CRC	The HMI data is corrupt	Download & reinstall the .STF file
E20: HMI baud rate	The HMI connection speed could not be established	Turn off and restart the SuperTrickler
E21: HMI file position	The position of the HMI data could not be found	Download & reinstall the .STF file
E22: Cannot downgrade	The current version does not allow for a downgraded version	
E23: extra write size	The unpacked extra file did not unpack to the correct size.	Check SD disk format or disk space
E24: extra read CRC	The data area of the .STF if corrupt.	Download & reinstall the .SFT file
E25: extra write CRC	The unpacked extra file did not write correctly.	Try again

E26: extra file position	The extra file in the .STF file could not be accessed	Download & reinstall the .SFT file
E27: Creating extra file	There was a problem creating the file that the extra file was unpacked into.	Check SD disk format or disk space
E28: ctrl firmware failed to load. (or the light does not flash for a while)	The controller firmware failed to load from the SD card. The format of the SD card is very important. The max size is 32GB (FAT 32)	Use a compliant SD card formatted using the SuperTrickler and retry.
E29: creating proforma file	There was a problem creating the proforma file.	Check SD disk format or disk space
E30: proforma write size	The unpacked proforma file did not unpack to the correct size.	Check SD disk format or disk space
E31: proforma read CRC	The data area of the .STF if corrupt.	Download & reinstall the .SFT file
E32: proforma write CRC	The unpacked proforma file did not write correctly.	Try again
E33: powder.dbl position	The powder.dbl part of the .STF file could not be accessed	Download & reinstall the .SFT file
E34: creating powder.dbl file	There was a problem creating the powder.dbl file.	Check SD disk format or disk space
E35: powder.dbl write size	The unpacked powder.dbl file did not unpack to the correct size.	Check SD disk format or disk space
E36: powder.dbl read CRC	The data area of the .STF if corrupt.	Download & reinstall the .SFT file
E37: powder.dbl write CRC	The unpacked powder.dbl file did not write correctly.	Try again
E38: powder.dbl position	The powder.dbl part of the .STF file could not be accessed	Download & reinstall the .SFT file
E39: Sub Header CRC	The Sub Header data area of the .STF if corrupt.	Download & reinstall the .SFT file

In most cases when an error occurs, reinstall the sft on to the SD card again and try again.

Restore

There are multiple ways to restore settings. These include a full factory reset, or the ability to just restore certain sections of the SuperTrickler.

Each restore button must be held in for at least two (2) seconds before the restore will take place to avoid unintentional execution.

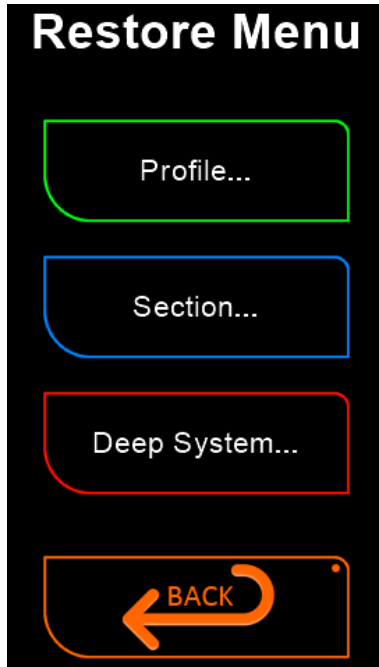

✦ **Profile:** Menu for resetting the default profile or to delete all the existing profiles.

✦ **Section:** Menu for general section restore; Powder Cup, Audio, Options & Scale.

✦ **Deep System:** *Use with caution.* This action allows you to reset the Deep System Settings, clear the memory and restore all defaults, or a complete system restore.

Deep System Settings

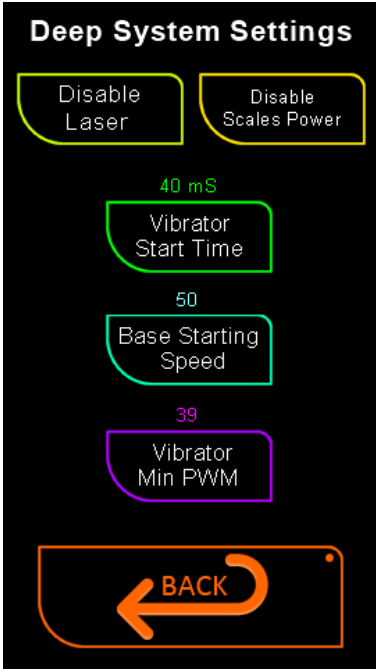

✳ **Disable Scales Power:** Used to disable the output of power to the scale from the SuperTrickler. Allows usage of the PSU from the scale. **CAUTION: Do not mix up the two power supplies, they are different polarity!**

✳ **Disable Laser:** Completely disable the laser and its subsystem.

✳ **Vibrator Starting Time:** Used to change the initial starting burst to the vibrating motor. Generally, 40 milliseconds is adequate to get the motor started. If your motor is not starting, try increasing this by 5 or 10 milliseconds at a time.

✳ **Base Starting Speed:** During the vibrator's automatic base speed cycle, the system initiates at the speed specified here. As a general guideline, this starting value should be set approximately 15–20 units higher than the typical final speed. This buffer allows the powder tube to fully charge, promoting a consistent flow before the trickling phase begins.

✳ **Idle Vibrator Min PWM:** is defined in PWM (Pulse Width Modulation) units and sets the vibrator's minimum running speed. These are the same units used by the Base Speed setting. Values below 29 will generally stall the motor, though some motors may stall at slightly higher values depending on wear, mounting, and load. A stalled motor typically produces a soft whistling sound and fails to deliver powder when it should; if this occurs, the Idle Speed value must be increased.

Other Systems and Information

Powder Flow Graph

The powder flow graph can be found at the top the following screens: vibrator setting, motor flow test, bulk test, fine, test, slow test & pulse test.

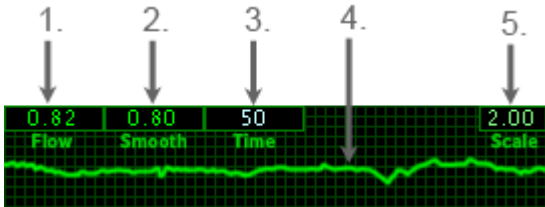

1. is the flow shown in grains.
2. is the filtered smooth flow.
3. is the time (seconds or milliseconds) in between flow data changes from the scale.
4. is the graph line showing the flow.
5. is the graph resolution scales (full scale deflection shown in grains). To change the scale resolution, simply touch anywhere of the graph and this will cycle through the available options.

Charge Weight Drift Monitoring

For five seconds after the charge (drop) is finished, the system will monitor the weight for any change outside of the tolerance. In the event that the weight drifts outside the tolerance band the red work-light will begin flashing (the green-light will remain on) to indicate a drift was detected. From this point it's up to the operator to accept or reject the charge.

The drift only monitors for 5 seconds because outside of this time frame the most likely cause of drift is scale drift and this is no longer indicative of the actual weight. The common causes of drift are after the charge a few kernels have fallen in or most likely the Final Stabilization time is too short; this is especially likely with large kernels that have much resonance and take a longer time for the scale to obtain a stable reading.

Micro SD Card

The SuperTrickler utilises a [Micro SD card](#) that has four core functions.

1. The first is to act as solid-state drive to hold the systems several databases.
2. The second functionality is to hold the .CSV log files containing the successful and failed charges.
3. The third is to store a record of the system settings for support analysis.
4. The fourth is for firmware updates.

⚠ WARNING: The micro-SD card itself acts as an ingress barrier into the electronics and it is very important not to load or empty the powder hopper when the card is removed.

Card Type

The maximum card size that is supported is 32GB. When replacing the card, a high-quality SD card such as a Kingston or SanDisk, is highly recommended. A cheaper card may work reasonably well but may slow your system down considerably. Further to this, a cheaper card may not support the firmware upgrades, as this is very card quality dependent. The card must be fully SD Association compliant.

Card Format.

It is critical that you use the SuperTrickler formatting function and not use a card formatted by a personal computer. Often personal computers do not format to the SD Association specifications. The card might work in general but may not support the firmware updates.

Please see the System – Peripherals – SD card, for details on how to initiate the card formatting function.

Card Removal and Insertion.

To remove the SD card, press on the card then release, and the card will release to the upper position for removal with your fingers or tweezers.

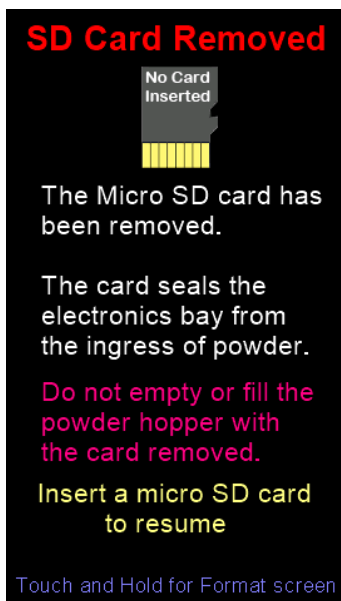

In most cases when the card is removed the SuperTrickler will display a warning screen (shown to the left) and will not function until the card is inserted.

To insert the card, place the card with the gold terminals facing the front of the machine, then gently insert it into the SD card slot. Once the card in the slot, press it down until it clicks into position.

⚠ Warning: Do not remove the card (or turn off the power) while a charge is taking place, unless the display is showing IDLE, or while a firmware upgrade is in progress or while formatting an SD card. The removal of the card or loss of power during a firmware update may permanently damage your SuperTrickler.

Note: If for some reason your will card cannot be detected, the cause maybe an incompatible or defective card format, touching anywhere on the screen for a few seconds will take you to the SD card screen enabling you to try reformatting the card (all card data will be lost).

Interface Ports

Located on the rear of the SuperTrickler.

Warning: These connections are for the use with only SuperTrickler equipment or approved third party equipment. Any other use or connection may permanently damage the SuperTrickler and is not covered under Warranty.

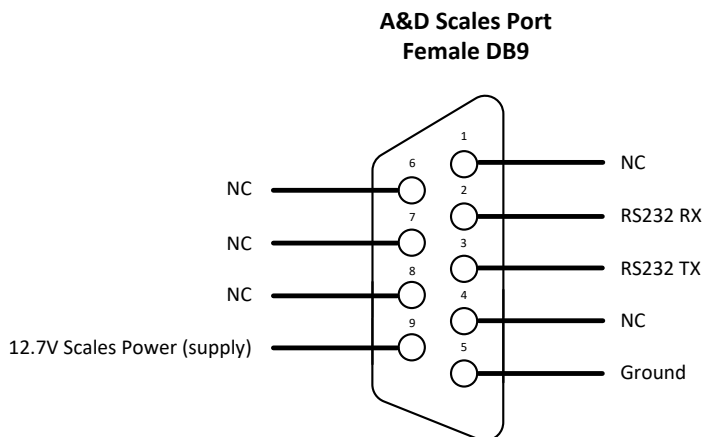
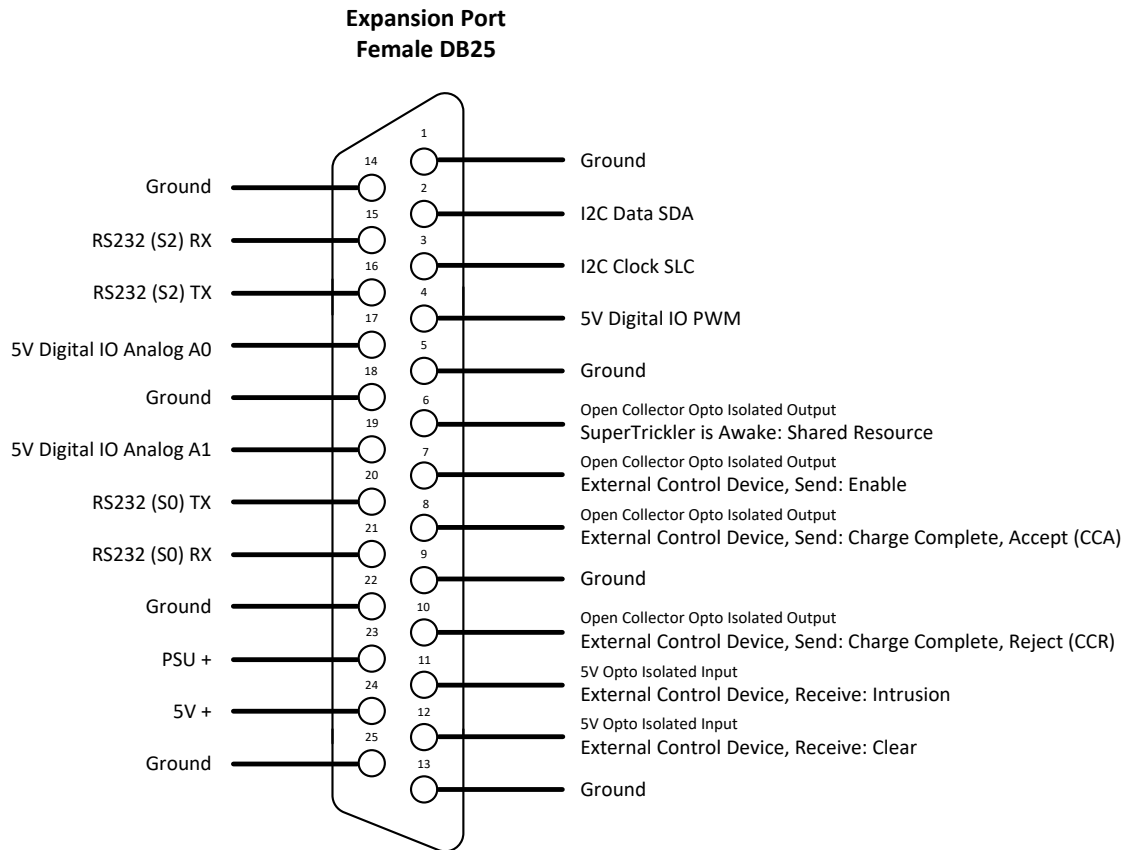

Log Files

The data logging ability of the SuperTrickler is an important feature. There are two main log files stored on the micro-SD card under a folder called \log. The files are Comma Separated Values (CSV) files, which can be opened on any spreadsheet program or text editor.

The log file size is limited to 3.9 gigabytes (an enormous amount of data), however it is recommended from time to time to back the files up and remove them as they grow too large (see Data Log File Backup below).

 **Note:** If you remove the files, the SuperTrickler will recreate the missing files.

For successful loads, the file is called “\log\loads.csv”. There are 2 formats available for this file. One saves some space by only writing the powder, batch and total powder used when the profile is changed. The ‘log every line’ format logs this information on every line. The file has the following standard fields:

Date, Time, Preset, Powder, Batch, Powder Used, Volume, Setpoint, Charge, Tolerance, Error, Consecutive, Fill Time, Process

Date is the date the charge occurred.

Time is the time of the charge.

Preset is the preset used to create this charge.

Batch is the batch value, if set.

Powder Used is a running total of the powder used for successful loads since the powder or preset was changed.

Volume is the volume of the cartridge set under pre-sets if it has been set.

Setpoint is the target charge weight.

Charge is the actual charge weight.

Tolerance is the tolerance setting for this charge.

Error is the difference between the Setpoint and the actual charge loaded.

Consecutive is the number of charges since the last error.

Fill Time is the time it took to create the charge.  **Note:** this does not include the ‘final’ analysis time.

Process is a coded string contain AI information on how the load was made.

 **NOTE:** if you desire extra fields for your own records, you can edit in extra headings using spreadsheet software or a text editor AFTER you save the log file locally on your computer.

Analysis Log File

For failed loads, the file is named \log\analysis.csv. This analysis file logs failed loads and, if the "Log all Charges in Analysis" option is selected, records all loads. It contains the same fields as successful loads but includes more detailed information to help our support team diagnose the cause of a failure.

A single or occasional failed load is not a concern. However, if failures persist, you can email this file to our support team for further analysis. support@supertrickler.com.au

The Self Learn column has a string of codes that indicate what the self-learning has changed after this charge was dispensed. The codes are....

E	Undefined error in self-learning.
Bi	Bulk Inflight value
Bs	Bulk Speed
Bo	Bulk Offset, generally changed by the Fine Operation, fine-tuning system.
Fi	Fine Inflight value
Fs	Fine Low Speed value
Fh	Fine High Speed value
Fr	Fine Ramp Down value
Ff	Fine Low Speed Final Phase value
Ps	Pulse Nominal Speed value
Po	Pulse Time ON value
Pd	Pulse Dither amount
Pi	Pulse Idle value
Pr	Pulse Ramping

Log Files Backup

Backing up your log files is recommended from time to time, using a laptop or personal computer.

 **Note:** You may need a Micro-SD to SD card adapter if your computer does not directly support Micro-SD cards.

1. Remove the Micro-SD card from the SuperTrickler (press down, release, then remove).
2. Insert the card into your computer.
3. Navigate into the Log folder.
4. Copy the .CSV file to a location on your computer.
5. If a file is getting large (nearing the 3.9GB limit) it is recommended to remove the large file, the SuperTrickler will recreate a new file automatically when the card is reinserted.
6. Once the backup has completed, reinsert the card back into the SuperTrickler (press in until it clicks).

User Notes...

Specifications for Generation 1 & 2

SuperTrickler standalone unit		
Empty Weight	1230 grams	
Height	265 mm (10.1")	
Width	183 mm (7.2")	
Depth	183 mm (7.2")	
Hopper volume (total)	725 grams of water	725CC (44.24 cubic inches)
Unusable Hopper volume	40 grams of water	40CC (2.44 cubic inches)
Scale Compatibility	A&D FZ/FX Series Precision Balance	With RS232 serial interface
Scale Weight Range Limit	-327.00 to 327.00 grains	Independent of attached scales
Scale Data Stream Weight Type	Grains or Grams	
Accuracy	0.02 grains	
Tolerance range	0.10 – 0.02 grains	
Compliance approvals	CE, EMC	With scale connected
SuperTrickler seated on A&D FZ/FX scale		
Empty Weight	3760 grams	With the scale pan, powder cup and serial cable.
Height	336 mm (13.2")	
Width	187 mm (7.4")	
Depth	260 mm (10.2")	
Power Supply Unit (PSU)		
Type	AC to DC	
Format	Wall Socket Mount	
Input Voltage	Range 80 – 264V	Nominal 110/230V
Plug Type	AUS, EU, UK, US	
Compliance approvals	CE, UL	
Output Voltage	15V	
Output Current	4.0A	
Weight	200 grams	
Height	56.2 mm (2.21")	
Width	39.1 mm (1.54")	
Power		
Max	33.5W	Rotating motor shaft locked
Typical During Charge	~16W	Rotating motor at 2000 mA
Idle	6.5W	White work light on
Idle	6.1W	White work light off
Sleep	4.7W	Scale remains in sleep
Powder Down	1.4W	Via SuperTrickler control
Powder Cup		
Volume	25.9 grams of water	25.9CC (1.58 cubic inches)
Empty Cup Weight	43.9 grams	Standard Cup

Generation 3 Specific

Generation 3 has some specific features and abilities, this section endeavours to describe this functionality.

Power Supply Unit (PSU)

Generation 3 machines use a standard **12V/2A (30W)** USB-C Power Delivery (PD) protocol power supply unit.

Door Switches

Generation 3 units are equipped with Hall Effect sensors (magnet detection) that enable recognition of an optional door installed on the dispensing chamber. The door may be mounted on either the left or right side of the opening. Detection settings can be configured via the System > Peripherals > Door Switches screen.

The Door Close Delay prevents the SuperTrickler from starting automatically until the specified delay has elapsed. This allows time for air currents caused by the closing of the door to settle.

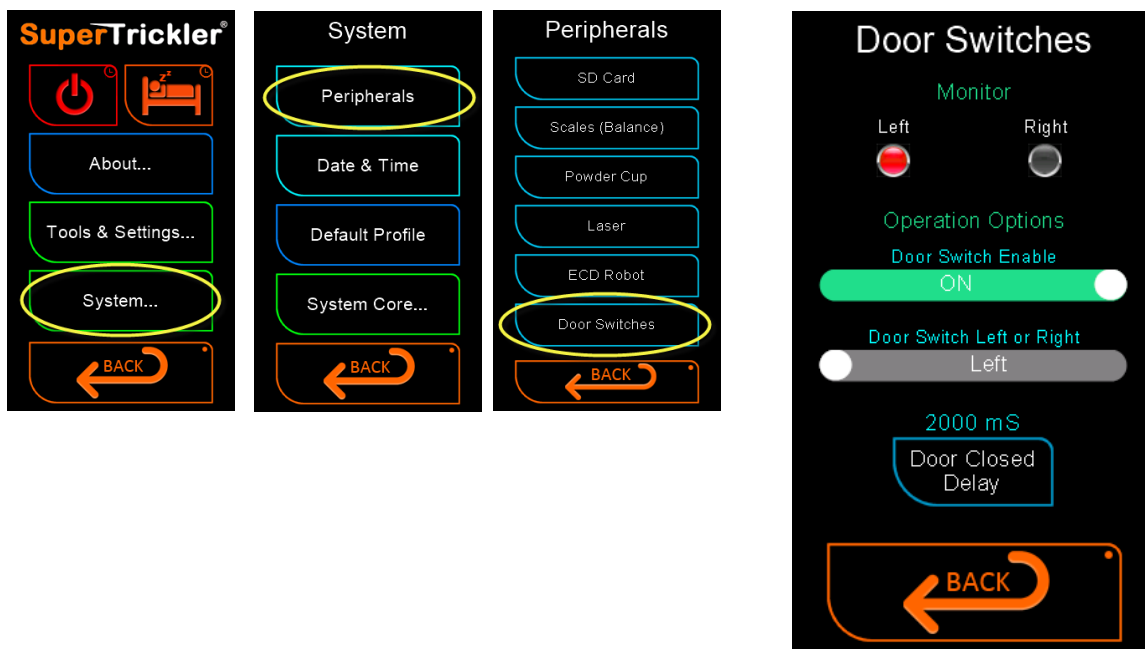

USB Flash Drive

Generation 3 includes a USB interface with limited capabilities that can significantly enhance the general operation of the SuperTrickler®.

⚠ Warning: The USB format is critical for the SuperTrickler®, as it uses a microcontroller rather than a standard computer. Windows and macOS operating systems typically do not produce a compatible format. Therefore, if you need to format your USB drive, you must download the Guiformat_X86_X64.zip file and run the appropriate application.

💡 Note: Due to the microcontroller interface, long file names and lowercase characters are not fully supported. Any long file names will be converted to the 8.3 naming convention, and lowercase characters will be automatically converted to uppercase.

The USB port provides limited but useful functionality. Unlike the SD card, it is not part of the core operational system. When a USB drive is first inserted, the system automatically creates two folders: **SEND** and **RECEIVE**.

Key Functions:

1. **File Transfer:** To and from the SuperTrickler.
2. **Firmware Updates:** Installing firmware (.stf files).

1. The SEND Folder (PC/Laptop → SuperTrickler)

To transfer files *to* the SuperTrickler (excluding firmware), place them in the **SEND** folder. The following files are accepted:

File	Description	Default SD Card Location
POWDER.DBL	Powder database	Root directory
PRESET.TXT	Presets file	Root directory
ANALYSIS.CSV	Log file	/Log/ folder
LOADS.CSV	Log file	/Log/ folder
WEIGHT.CSV	Log file	/Log/ folder
PRESET.CSV	Fundamental presets list	/Log/ folder
PF.DAT	System proforma file	/sys/ folder

To transfer files from the USB flash drive to the SD card, place the desired file(s) in the **SEND** folder. Files are transferred in groups (overwriting and existing files):

- Power & Preset
- Log Files
- System Proforma (rarely used, if ever)

Only the files present in the selected group will be transferred. No error will occur if a file from the group is missing..

2. The RECEIVE Folder (SuperTrickler → USB Drive)

For easy access to files, the system can copy the following files to the **RECEIVE** folder on your USB drive. The files and their source locations are:

File	Description	Default SD Card Location
POWDER.DBL	Powder database	Root directory
PRESET.TXT	Presets file	Root directory
ANALYSIS.CSV	Log file	/Log/ folder
LOADS.CSV	Log file	/Log/ folder
WEIGHT.CSV	Log file	/Log/ folder
PRESET.CSV	Fundamental presets list	/Log/ folder
PF.DAT	System proforma file	/sys/ folder
*.TXT	Detailed profile information files	/Share/ folder

When transferring file(s) from the SD card to the USB flash drive, the files will be placed in the USB **RECEIVE** folder, overwriting any existing files. Transfers occur in groups.

- Power & Preset
- Log Files
- System Proforma (rarely used, if ever)
- Shared Folder

3. Firmware Updates

To perform a firmware update:

1. Place the firmware file (.stf) directly into the **root directory** of the USB flash drive (not in any folder).
2. Insert the drive into the SuperTrickler.
3. The system will automatically detect the file and launch the firmware update screen.

Accessing the USB flash drive functionality

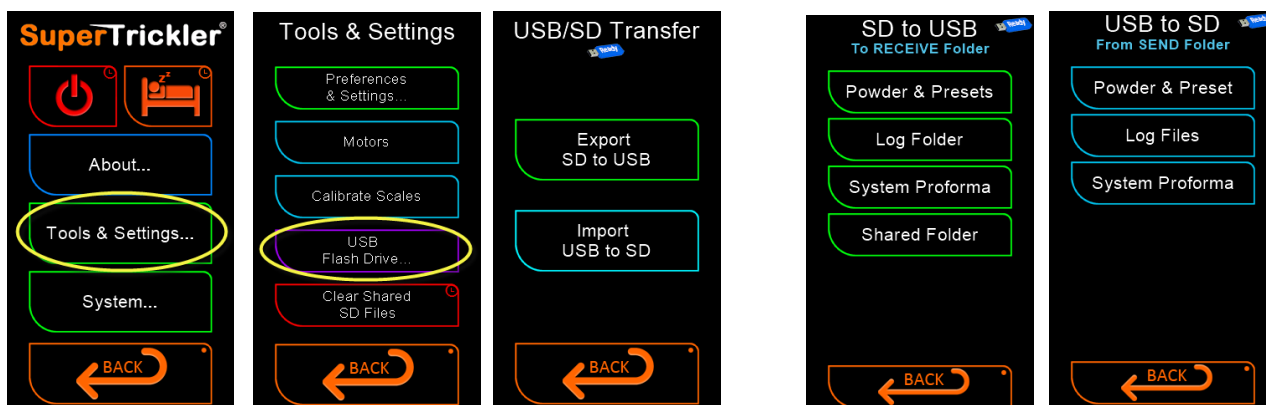

Specifications for Generation 3

SuperTrickler standalone unit		
Empty Weight	1175 grams	
Height	265 mm (10.1")	
Width	183 mm (7.2")	
Depth	183 mm (7.2")	
Hopper volume (total)	1429 grams of water	1429CC (87.2 cubic inches)
Unusable Hopper volume	40 grams of water	40CC (2.44 cubic inches)
Scale Compatibility	A&D FZ/FX Series Precision Balance	With RS232 serial interface
Scale Weight Range Limit	Full range of scale	
Scale Data Stream Weight Type	Grains or Grams	
Accuracy	Scale dependant	0.02 / 0.01 / 0.002 grains
Tolerance range	0.100 – 0.002 grains	Scale selection dependant
Compliance approvals	CE, EMC	With scale connected
SuperTrickler seated on A&D FZ/FX 120i, 300i, 104, 254		
Empty Weight	3760 grams	With the scale pan, powder cup and serial cable.
Height	336 mm (13.2")	
Width	187 mm (7.4")	
Depth	260 mm (10.2")	
Power Supply Requirements		
Type	USB-C PD 3.1	
Voltage	12V	
Max	33.5W	Rotating motor shaft locked
Typical During Charge	~16W	Rotating motor at 2000 mA
Idle	6.5W	White work light on
Idle	6.1W	White work light off
Sleep	4.7W	Scale remains in sleep
Powder Down	1.4W	Via SuperTrickler control
Powder Cup		
Volume	25.9 grams of water	25.9CC (1.58 cubic inches)
Empty Cup Weight	43.9 grams	Standard Cup

Support

Before contacting us, please refer to the [common problems](#) section at the end.

If you require additional help, you can contact our support team at support@supertrickler.com.au, though please allow several days for a response as the support desk is not manned fulltime. A member of the support team may request you to email one or more files held on the Micro SD card to assist in the resolution of the problem.

A Friendly Note on Support

We understand that seeking support can sometimes be frustrating—especially when things aren't working as expected. However, we've found that many support requests stem from users not having read the companion document or the Owner's Manual. This often becomes clear when there's confusion around basic concepts or terminology, with questions like "How do I do that?" highlighting a lack of familiarity with the system.

This can place unnecessary strain on our support team, who must spend time explaining fundamental operations and navigating terminology mismatches. Users may describe features using their own terms, which can make it challenging to communicate effectively—especially when those terms differ from the standardized language used in the manual.

We fully acknowledge that the Owner's Manual is comprehensive, and it may seem like a lot to take in. That said, it's an essential resource designed to help you get the most out of your SuperTrickler. One of our common support questions is, "Have you read the manual?"—and while the answer is often "Yes," it's sometimes clear that key sections have been missed.

To ensure we can provide the most efficient and helpful support possible, our team may ask you to review relevant sections of the manual before proceeding with troubleshooting. If you truly want to unlock the full potential of your SuperTrickler, we strongly encourage you to read the Owner's Manual—especially the Profile section.

Thank you for your understanding and for being part of the SuperTrickler community.

Feedback

The SuperTrickler was designed and developed on the concept of giving reloaders what they are asking for. We have always welcomed feedback from our followers and will extend that to our users. Not every idea is feasible however, when possible, with a great idea or with enough people asking for a change, we will endeavour to implement changes to refine the SuperTrickler moving forward. We maintain a list of future plans, ideas, and thoughts. Some of these have already been flagged for near future firmware releases that time has not permitted us to reveal in the first firmware version. The progression from idea to practical application and impact considerations is often a slow process and so it should be. The change benefit and potential negative impact, along with costs must be considered with every idea, but without ideas and an understanding of what our users want from the SuperTrickler, the product becomes a stagnate product like many similar products on the market. This is not what we want and therefore invite you to share your feedback and ideas with us by email at support@supertrickler.com.au

Appendix A: Upgrade/Firmware Naming Conventions

The firmware file names follow the naming convention listed below:

Prior to Version V1.00 to and including 2.00 only

Examples: SOC2-0N2-0T1.stf : SOC1-4N.stf : SOC1-5N Patch 6.stf

***bold is not optional**

S = Serial Number.

- serial number, 0 = all machines.

C = Controller Board Firmware Version.

- Major Version.

- dash

- Minor Version.

N = User Interface (HMI), N dictated the TFT brand name.

- Major Version.

- dash

- Minor Version.

T = TFT (user interface) type

- Type number

[space]

Patch

- number

.stf

Linear layout: Serial #, Firmware Version, [UI Version & Type], [patch]

From Version V2.10 to V3.1.0

Naming convention changed for clarity and better content information.

Example: V2-10T1U2-10T1-X.stf : V2-20T1-X.stf : V2-10T1 Build 2.stf : V2-20T1-S122090203.stf

***bold is not optional**

V = Firmware Version

- Major Version.

- dash

- Minor Version.

T = Controller Board Type.

- Type number.

U = User Interface (HMI).

- Major Version.

- dash.

- Minor Version.

T = User Interface Type.

- type number.

-X dash X indicates the stf file is carrying an undefined extra file.

-S dash S, the file has been built for specified machine.

serial number.

Linear layout: Firmware Version & Type, [UI Version & Type], [extra file], [Serial #], [build]

From Version V3.2 to V3.2.2

Naming convention changed for clarity and the upgraded packaging ability.

Example: V2-10T1U2-10T1-X.stf : V2-20T1-X.stf : V2-10T1 Build 2.stf : V2-20T1-S122090203.stf

***bold is not optional**

V = Firmware Version

- Major Version.

. dot

- Minor Version.

. dot

- Build.

T = Controller Board Type.

- Type number.

U = User Interface (HMI).

- Major Version.

. dot.

- Minor Version.

T = User Interface Type.

- type number.

- dash

X dash X indicates the stf file is carrying an undefined extra file.

P the file contains the powder.dbl file

F the file contains the proforma file.

-S dash S, the file has been built for specified machine.

serial number.

Linear layout: Firmware Version & Type, [UI Version & Type], [extra files], [Serial #]

From Version V3.2.3 onwards

Naming convention changed for clarity and the upgraded packaging ability.

Example: V3.2.3T1-H1PFX.stf

***bold is not optional**

V = Firmware Version

- Major Version.

. dot

- Minor Version.

. dot

- Variation Number (build).

T = Controller Board Type.

- Type number.

- dash

H = User Interface (HMI) is attached.

- user interface type number.

P = powder.dbl file is attached

F the file contains the proforma file.

X dash X indicates the stf file is carrying an undefined extra file.

Linear layout: Firmware Version & Type, [additional files]

Appendix B: Common Problems

Problem	Fix
<i>Dispensing</i>	
Rotating tube stops or has stopped turning or is making a clunking sound.	<ol style="list-style-type: none"> 1. Empty the hopper then remove the tube and clean the motor drive and the back of the tube as well as the motor shaft and opening. You can use a small paint brush or gentle compressed air. 2. Increase the bulk motor current in the bulk profile settings.
Vibrator tube does not seem to be working as well as it has been or is not delivering powders.	<ol style="list-style-type: none"> 1. Gently pull on the tube to ensure it is all the way out, WITHOUT ROTATING THE TUBE. 2. Make sure there is sufficient powder in the hopper. 3. If it stutters or stops running, try increasing the start time in the deep settings.
The AI is not learning well.	<ol style="list-style-type: none"> 1. Check your vibrator speed settings 2. Reset the profile or the instrument that is not performing well and let the AI learn again.
The AI will not turn off with the purple scholar's hat displayed.	The AI is in monitor mode, it knows the profile is not running the best but cannot pinpoint the problem. There is no harm in letting it run or you can turn it off manually in the profile under self-learning.
Low Success	<ol style="list-style-type: none"> 1. If the bulk overthrows a lot, try reducing the speed to 90-95% in the profile settings. 2. Check your vibratory tube speed settings as stated above in the AI not learning section 3. Check for adequate amount of powder in hopper. 4. Turn the profile more 'vibrator off mode' to Stop 5. Change the Vibrator Base Speed Offset
<i>Upgrade</i>	
Error during an upgrade or the process just froze.	Download the upgrade stf file again and try another installation (do not format the SD card).
If the power goes off during an upgrade.	Contact support. support@supertrickler.com.au
<i>Setup</i>	
Scales will not read.	<ol style="list-style-type: none"> 1. Make sure the cable is completely plugged in.

	<p>2. The scales need to be setup; ensure you have setup the scales as per the instructions in the SuperTrickler users manual. .</p> <p>3. Double check the scale program settings going through the scale menus. Checking that ALL settings are correct including the ones marked with a red highlight.</p>
I still cannot get the scales to read.	As per the instructions, do a factory restore of the scale settings. Then start again setting up the scales, ensure all settings are as prescribed correct including the ones marked with a red highlight.
Error: Scales Date Rate Slow	Scale setup error: Check the Base Functions, Display Refresh Rate and ensure its set to 2, 20 times/second.
Flashing Lights	
Soon after a powder drops, the work light begins flashing between green and red.	The drift monitor has detected that, since the powder drop was finalized, the weight has drifted. This is a warning that the charge may not have had enough time to fully stabilize. If this happens regularly, increase the final stabilization time.
The red light is flashing continually	The Bulk Tube has been removed. See the <i>Change Bulk Tube</i> section.
Misc	
I formatted my SD card and lost everything.	<p>Formatting should not normally be required for any part of the SuperTricklers operation including updating.</p> <p>The SuperTrickler will automatically recreate critical files however you must download the powder.dbl file and proforma file (profile.pf) to suit your version from the ancillary file section of the web site: https://supertrickler.com.au/powder-database/ Place the files on the root (top folder) of the SD card then reinsert the card.</p>
My powder.dbl file is missing	<ol style="list-style-type: none"> 1. Download the powder.dbl file from the ancillary file section of the web site: https://supertrickler.com.au/powder-database/ Place the file on the root (top folder) of the SD card then reinsert the card. 2. Check the file is called "powder.dbl" and not some other name like "powder (1).dbl"

1202 Database Error

In earlier versions, an unresolved issue existed where, in the event of a timing issue with the SD card database, the system would issue a 1202 error and disable the database to protect it from damage. In later versions, this has been resolved. Fix files are available to download from <https://supertrickler.com.au/miscellaneous/>

----- END OF DOCUMENT -----