

# SuperTrickler<sup>®</sup>

When True Precision Matters



**ST101 Owner's Manual**

**V3.2.0**

# Important Safety Instruction

Thank you for purchasing your Petersen Kowald SuperTrickler® ST101 smokeless gunpowder dispensing unit. We want you to get the best out of this easy to use and feature rich unit. Taking a small amount of time to read this manual will greatly benefit you in getting the SuperTrickler working for you and getting the most from its benefits and functionality.

The manual contains important safety, installation, and operating instructions for the SuperTrickler and compatible A&D balance (scale). Do not operate the SuperTrickler or balance unless you have read and understood the specifics of the instructions.

Petersen Kowald is a collaboration between Rex Petersen & Peter Kowald for the development of the SuperTrickler®. The manufacturing, ownership, sales, and support is the responsibility of Modgunn Security ApS (Denmark).

## **Disclaimer**

Gunpowder is a dangerous material and before using this equipment and before reloading, we recommend that you seek expert advice on the proper use of all products, handling, procedures, and charge quantities. Rex Petersen, Peter Kowald, SuperTrickler® & Modgunn Security ApS take no responsibility for any harm or damage that may result from use of the SuperTrickler® and the reloading process.

## **General Safety**

Failure to adhere to the following safety rules can result in property damage and/or serious personal injury. Read and understand the safety rules before attempting to reload ammunition.

Only reload ammunition when you can give your full and undivided attention. Avoid distractions such as television, visitors, or any other factors that may adversely affect your concentration.

NEVER attempt to reload while under the influence of alcohol, drugs or medications that may affect concentration or judgment.

Thoroughly read and understand all reloading equipment instructions before using that equipment. If you do not understand the written instructions, contact the manufacturer of the piece of equipment for clarification before proceeding.

Wear approved safety glasses during all reloading operations and make safety glasses available to any approved visitors to your loading area.

Make certain that all equipment is appropriately anchored to, or placed on, a solid work surface during use. Follow the tools manufacturer's instructions for safely mounting of all equipment.

Observe good housekeeping in the reloading area. Clean up spills promptly and limit the components on the bench to only those required for the immediate task at hand.

Keep accurate and legible records; the SuperTrickler can log and track powder batches, however, it is up to the operator to ensure the correct information is entered into the system. Label everything so there is no confusion regarding the ammunition or components.

Store and keep powder and primers away from sources of heat, open flame and out of the reach of children and follow your country's legal requirements for storage.

Do not smoke, eat, or drink in the loading area.

Keep powder and primers in their original, factory-marked containers. Discard any components that lose their identification information. If you must remove any components from their factory containers during loading, return them to their proper containers as soon as the dispensing session ends to prevent the ingress of moisture or other contaminants.

Keep no more than one container of propellant on the bench at a time. Store other powders away from the bench to avoid mistakes or mixing.

Carefully read and follow published reloading data. Verify that your loading manual is open to the correct page for the cartridge you are loading.

The SuperTrickler is designed exclusively for the FZ/FX series of balances (scale); never attempt to use the SuperTrickler with any unapproved brands or models. The balance must be warmed up for at least the manufacturer's recommended period of time and calibrated before reloading commences.

Keep the balance (scale) clean and remove the powder cup, dust & debris before calibration.

Calibration weights must be accurate and clean. It is recommended that the weights are never touched with bare hands and the use of thin cotton gloves, or a lifting tool, should be used.

The balance is a sensitive piece of equipment and care must be taken not to drop the unit or drop anything onto the unit. In the event that the unit has been (or has potentially been) damaged, it must be returned to the manufacturer or approved repairer.

Avoid locating balance within three feet (one meter) of fluorescent lights. The electromagnetic fields generated by such lights can cause weighing errors.

Never use damaged equipment, contaminated, or damaged products for the reloading process.

It is not recommended to have transmitting equipment such as cell phones or other strong transmitters near your reloading equipment. This type of equipment can interfere with the data communications between the scale and the SuperTrickler and may also interfere with the scale operation and calibration.

Cell phones and other devices with batteries are a fire risk and it is not recommended to have such devices present in the vicinity of gunpowder.

The SuperTrickler is equipped with a touchscreen display; the screen is designed to be operated with your finger or soft blunt pointer only. Do not use a hard or sharp object to operate the touchscreen.

## **Warnings**

**DO NOT USE WITH BLACK POWDER:** This equipment is designed and approved for smokeless gunpowder only.

**Do not remove the bulk trickler tube with powder in the hopper.** Doing so will allow powder into the body of the unit and will require cleaning from an authorised service center, at your cost.

**Micro SD Card:** The unit must not be used, filled, or emptied without the Micro SD card installed, as the location of the card prevents the ingress of material into the electronics bay.

**Do not use an unapproved Power Supply Unit.** The power supply unit supplied with the A&D precision balance **MUST NOT BE USED**, on either the SuperTrickler or the balance unit, while the SuperTrickler is connected. The precision balance obtains its electrical power from the SuperTrickler and must not be used in conjunction with any other power source. The SuperTrickler is supplied with a very high-quality medical grade power supply unit. This is the only approved power supply. Spare units are available from SuperTrickler if required. The use of another power supply may damage the SuperTrickler and or the A&D precision balance and will void the Warranty of either, or both units.

## Scales/Balance

Scales and balances are both weighing machines. They are different in that a scale measures weight while a balance measures mass. Weight is the force of gravity on an object and a balance compares the mass of two different objects. The term 'scale' or 'scales' historically has been used in reloading to describe the weighting device and as such will be used throughout this document.

## General Terminology

Scale: The A&D FZ/FX series balance.

Weight: The amount of powder as weighed by the scale.

Powder: refers to smokeless gunpowder.

Load, Charge and Drop: refers to powder dispensed for the purposes of loading a bullet.

AI: is the acronym for Artificial Intelligence.

SD card: refers to the Micro SD Card.

## Warranty

The SuperTrickler® is covered by a two (2) year comprehensive warranty. This Warranty covers all components supplied with the SuperTrickler (Main unit, Power Supply, MicroSD Card, cables and accessories.) Shipping in both directions for warranty repairs (once approved) is also covered. For any warranty claims, please contact [services@supertrickler.com.au](mailto:services@supertrickler.com.au)

The Warranty period starts on the date of the supplied Invoice from Modgunn Security ApS and is transferable to second and future owners.

**IMPORTANT: YOU MUST KEEP A COPY OF THE SUPPLIED INVOICE, AS THIS IS YOUR ONLY PROOF OF PURCHASE AND IS YOUR WARRANTY REGISTRATION. IF YOU SELL YOUR UNIT, YOU MUST PROVIDE A COPY OF ORIGINAL INVOICE TO THE NEW OWNER FOR THEM TO HAVE A VALID TRANSFERRED WARRANTY. WITHOUT PRESENTING THE ORIGINAL INVOICE YOUR WARRANTY MAY BE INVALIDATED. COPIES/IMAGES OF THE ORIGINAL INVOICE ARE ACCEPTABLE.**

Limitations:

- Removal of any security/warranty stickers on the unit will void all warranties.
- Connecting any unapproved device, wiring, connectors etc to the 25-pin expansion port, or 9 pin Scales port will void all warranties.
- Damage caused by loading powder without the large rotation bulk tube in place is not covered under warranty.
- The use of an unapproved power supply unit (PSU) will void all warranties.
- General physical abuse (as evaluated by Modgunn Security ApS) is not covered under warranty and may void all warranties.
- If you purchased your A&D Scale from Modgunn Security ApS, you should register it online with A&D at <https://weighing.andonline.com/support/warranty>.

## **This Document**

This document was specifically written for the SuperTrickler® ST101 firmware version 2.2, SuperTrickler & Modgunn Security ApS, maintain the right to change this document and or the firmware at any time without notification.

This manual should be read and understood before operating the SuperTrickler. If you have questions, or are having difficulty understanding any of this documentation, please contact our support desk:

[support@supertrickler.com.au](mailto:support@supertrickler.com.au)

To find the latest version of this document, and all applicable downloads, please go to one of the applicable places on our website:

Home: <https://supertrickler.com.au>

Documentation: <https://supertrickler.com.au/documentation/>

Firmware Downloads: <https://supertrickler.com.au/files/>

Powder Database file: <https://supertrickler.com.au/powder-database/>

Also, there are several Facebook groups related to the SuperTrickler®:

SuperTrickler FB Group: <https://www.facebook.com/groups/174920460551694>

SuperTrickler FB Owners Group: <https://www.facebook.com/groups/1226539671258233> (you will need your order number to join this group) The owners group is where you will find the best support, only owners are in this group so that questions can be asked freely without outside interference.

# Table of Contents

---

## Table of Contents

|   |    |
|---|----|
| General .....   | 10 |
| Introduction.....   | 10 |
| Key Components.....   | 11 |
| Front .....   | 11 |
| Top.....  | 12 |
| Bottom.....   | 12 |
| Rear.....   | 13 |
| Installation.....   | 13 |
| Scale.....  | 13 |
| SuperTrickler.....  | 14 |
| Programming the Scale.....  | 16 |
| Testing the communications .....  | 23 |
| Level & Calibrate the scale .....   | 24 |
| Setting the clock .....   | 24 |
| Filling and Emptying the Gunpowder Hopper.....  | 25 |
| Filling.....  | 25 |
| Emptying.....   | 25 |
| Quick Start – let’s have some fun.....  | 26 |
| Vibrator Speed Settings.....  | 26 |
| The trade-off between speed and failures.....   | 28 |
| Menu System.....  | 30 |
| Special Buttons. There are several types of special buttons that you find throughout the system. .... | 31 |
| Hold to activate .....  | 31 |
| Quick Return.....   | 31 |
| Artificial intelligence Self-Learning .....   | 31 |
| Main Sub Menu .....   | 32 |
| Soft keypads .....  | 33 |
| Numeric Keypad .....  | 33 |
| Alphanumeric Keypad .....   | 34 |
| Vibrator Warmup Option .....  | 35 |
| Dispensing .....  | 35 |

|   |    |
|---|----|
| From the Main Menu .....                | 35 |
| Dispensing Screen.....                  | 36 |
| Dispensing Screen Functionality.....    | 37 |
| Charge Setpoint .....                   | 40 |
| Selecting a Powder or Pre-set .....     | 40 |
| Powder & Pre-set Profile Database ..... | 40 |
| Selecting a Powder .....                | 41 |
| Pre-set Charge Profile Database.....    | 41 |
| Selecting a Preset profile .....        | 42 |
| Creating a new pre-set .....            | 43 |
| Modes.....                              | 44 |
| Ladder Mode Setup .....                 | 45 |
| Top Up Mode.....                        | 46 |
| Weight Logging Mode .....               | 47 |
| Empty Hopper.....                       | 48 |
| Operational.....                        | 49 |
| Tools & Settings Menu .....             | 49 |
| Options & More.....                     | 49 |
| Options .....                           | 50 |
| Automatic power up times.....           | 53 |
| Motors .....                            | 54 |
| Change Bulk Tube .....                  | 54 |
| Motor Testing .....                     | 55 |
| Calibrate Scales.....                   | 56 |
| Scale Calibration Weight .....          | 56 |
| Profile Import Export .....             | 57 |
| System .....                            | 60 |
| System Menu.....                        | 60 |
| Peripherals.....                        | 60 |
| SD Card .....                           | 61 |
| Scales (Balance) .....                  | 62 |
| Powder Cup Scales Monitoring .....      | 63 |
| Powder Cup Laser Sensor .....           | 64 |
| Date & Time.....                        | 65 |
| Expansion Port.....                     | 65 |

|   |    |
|---|----|
| Setup Menu .....  | 66 |
| Factory Restore.....  | 66 |
| System Core Menu .....  | 67 |
| Firmware Update.....  | 67 |
| Important: Roll Back Strategy.....  | 68 |
| Install .....   | 68 |
| Update Error codes.....   | 69 |
| Deep System Settings .....  | 72 |
| Charge Log Files .....  | 72 |
| Log File Backup .....   | 73 |
| Powder Profile .....  | 75 |
| Control System Philosophy.....  | 76 |
| Inflight Concept and Inflight Tracking .....  | 77 |
| Inflight Tracking Filtering.....  | 77 |
| Vibrator Speed Settings.....  | 79 |
| How to set the Vibrator Speed Settings step by step.....  | 80 |
| When does the offset apply and how does it work At the end of the Automatic Base Speed detection the offset is automatically applied to base speed value. From the base speed setting the system will automatically take you to the high speed limit setting where the ability to change the offset can be carried out. From Vibrator High Speed screen, the Vibrator Base Speed is shown along with the offset value. The base speed is displayed with the offset value applied. In the event you choose to change this value, pressing the Base Speed Offset button will enable a new value between -20 to 0 to be applied. If you fail to make the value a negative number, the system will convert it automatically. An out-of-range value will result in the default offset being applied..... | 81 |
| Instruments .....   | 82 |
| Profile Variables.....  | 83 |
| More Settings .....   | 84 |
| Tolerance .....   | 85 |
| Bulk Instrument.....  | 87 |
| Process of the Bulk Instrument. ....  | 87 |
| Bulk Instrument Parameters .....  | 87 |
| Fine Instrument .....   | 90 |
| Process of the Fine Instrument. ....  | 90 |
| Fine Instrument Parameters.....   | 90 |
| Slow Instrument .....   | 94 |
| Process of the Slow Instrument.....   | 94 |



|   |     |
|---|-----|
| Slow Instrument Parameters.....                       | 94  |
| Pulse Instrument .....                                | 96  |
| Dithering .....                                       | 96  |
| Ramping.....  | 96  |
| Process of the pulse Instrument.....                  | 96  |
| .....   | 97  |
| Pulse Instrument Parameters.....                      | 97  |
| AI Self-Learning Settings.....                        | 100 |
| Gestalt’s (down the rabbit hole).....                 | 100 |
| AI Scholar Hat Icon .....                             | 100 |
| Heuristics .....                                      | 101 |
| Self-Learning Parameters .....                        | 101 |
| Profile Reset .....                                   | 102 |
| Powder Profile Summery.....                           | 103 |
| Powder Flow Graph .....                               | 104 |
| Charge Weight Drift Monitoring.....                   | 104 |
| Micro SD Card.....                                    | 105 |
| Card Type.....  | 105 |
| Card Format.....                                      | 105 |
| Card Removal and Insertion. ....                      | 105 |
| Interface Ports .....                                 | 106 |
| Specifications.....                                   | 107 |
| Support .....   | 108 |
| Feedback.....   | 108 |
| Appendix A: Upgrade/Firmware Naming Conventions ..... | 109 |
| Appendix B: Common Problems.....                      | 111 |

## **General**

### **Introduction**

The **SuperTrickler®** is the most advanced and unique gunpowder dispenser available on the market. Here's why:

It took nearly three years to develop this highly sophisticated, user-friendly, fast, and accurate dispenser, designed for both novice and experienced home users.

The SuperTrickler uses an external laboratory balance from A&D, boasting an accuracy of 0.02 grains. Delivery from its generous hopper is managed by a two-tube system: a rotating tube for fast bulk delivery and a fine vibrating tube for the final touches. The result is a quiet, fast, and precise charge that saves valuable time and ensures precision.

### **Artificial Intelligence Integration**

The SuperTrickler employs Artificial Intelligence (AI) to assist in the process, featuring self-learning, proactive process monitoring, operation analysis, and dynamic operation—unlike other units on the market, which use a fixed control sequence. The system also allows the operator to easily trim it and make operational decisions that suit their preferences.

### **Unique Features for Enhanced Precision**

To reduce mishaps, the SuperTrickler includes an experimental laser that detects whether the cup is in position before starting a charge. It also has a fast and clear standalone color touch screen interface that is intuitive to use, coupled with an extensive database containing many known powder types. This database can be easily updated or personalized and includes powder use tracking and reporting, which is essential for meeting legal obligations in some countries.

### **Comprehensive Data Logging**

The data logging feature is extensive, with several separate log files that can be easily read and edited with any spreadsheet program. The log files include successful charges with all powder and tolerance details, as well as unsuccessful charges with extensive details on how the charge process was carried out by the AI engine, powder profile details, and the root cause of the error. This feature simplifies remote support if you encounter ongoing issues. Additionally, there are log files that record settings and supplementary information, significantly improving the support personnel's ability to identify and resolve any issues quickly and efficiently. The system includes the option to select a date format that suits your country.

### **Other Notable Features**

- Easy automatic laddering.
- Unlimited pre-set charges for all your common loads.
- Self-learning feature that can easily be controlled or turned off to suit your own preference for speed and success.
- Automatic turn on and warm-up timers, ensuring your trickler is ready when you are.
- Soft buttons and/or timers to initiate sleep or power down.

- Sectionalised factory restores in case you find yourself with undesired results or just want to experiment with the system.
- Easy A&D balance calibration, with a user-friendly interface to calibrate the balance. This can be selected to be called every time you start your unit after the warm-up time.
- Easy firmware updates that are intensively verified to ensure smooth updates, including rollbacks.
- All successful and failed charges are supported with a colored light display and tone sequence to ensure the operator is aware of a failed charge (optional).
- Customizable tones to aid anyone with a hearing deficiency, with the option to disable them for silent operation.
- An extensive and future-proof expansion port that allows for external interfacing and operational control, label printers, temperature/humidity monitoring, and other devices with I2C and serial interfacing.

## Key Components

### Front



**PLEASE NOTE:** The SuperTrickler has two separate dispensing tubes; the large lower bulk rotating tube and the small upper fine vibrating tube (this tube does not rotate).

**Important Warning:** The vibrating trickler tube is a delicate component and must not be pushed, pulled or flexed, gently pulling it to ensure it is all the way out is acceptable. Harsh manipulation can destroy the tube and is not covered under Warranty.

## Top

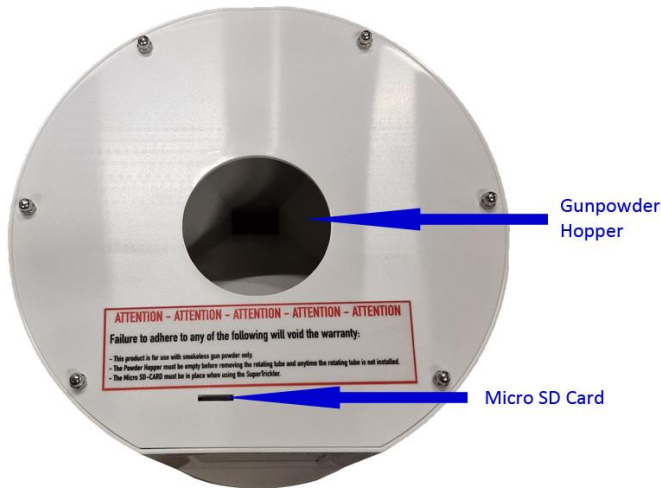

**Note 1:** It is normal that the inside of the Gunpowder hopper will discolor over time.

**Note 2:** The hopper does not have a cover; this is intentional as the SuperTrickler is not a storage container. Gunpowder is hygroscopic and can absorb moisture if not stored properly; for safety reasons, the powder should **always** be stored in its original container.

**Note 3:** Do not pour gunpowder into the hopper without the Micro SD card installed. The card acts as a seal to the electronics bay and doing so will void your Warranty.

In the event that you accidentally spill powder into the electronics bay, do not operate the SuperTrickler and contact [support@supertrickler.com.au](mailto:support@supertrickler.com.au) for advice.

## Bottom

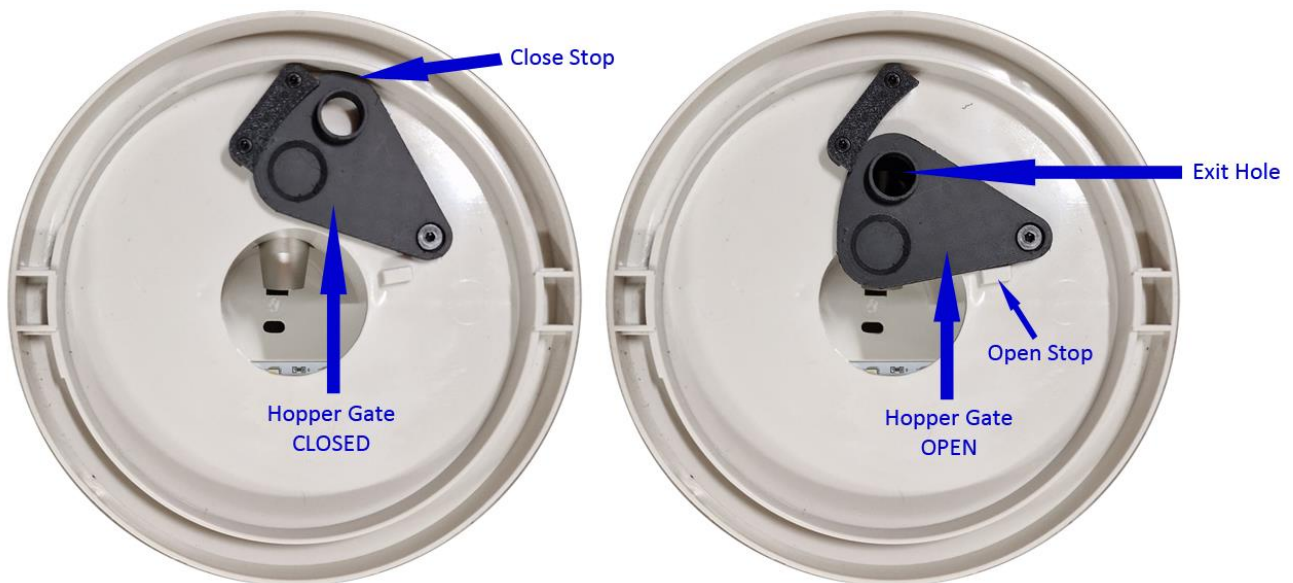

The SuperTrickler will not seat into position on the scale if the hopper gate is not fully closed, to prevent accidental spillage of powder.

**Warning:** Do not force SuperTrickler onto the scale. If the hopper gate is not fully closed, you may damage your scale.

## Rear

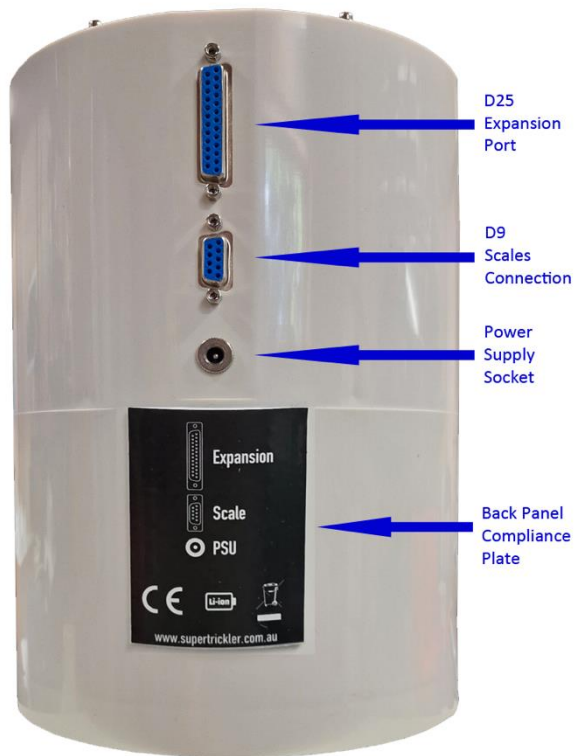

## Installation

### Scale

The scale is a precision instrument. Unpack it carefully. It is recommended to keep the packaging materials. **DO NOT** set it up as per the A&D FX/FZ series owner's manual, as the SuperTrickler requires a different arrangement.

The following standard A&D balance components are **NOT** required for use with the SuperTrickler:

- Wind shield
- Scale plate and top plate
- The power supply once the SuperTrickler is attached (The SuperTrickler will supply power to the scale via the 9-pin cable).

Only the main scale unit is required for use with the SuperTrickler.

Please heed any precautions specified in the A&D owner's manual.

[https://weighing.andonline.com/sites/default/files/documents/FX\\_FZ-i\\_Instruction%20Manual.pdf](https://weighing.andonline.com/sites/default/files/documents/FX_FZ-i_Instruction%20Manual.pdf)

## SuperTrickler

Unpack the SuperTrickler carefully, it is recommended to keep the packaging materials.

1. Carefully install the SuperTrickler's custom scale plate into the scale plate slot, taking care not to press it in too hard (your scale is an expensive and delicate instrument).



2. Place the SuperTrickler's main body onto the scale, locating it such that it sits flat on the scale (note the locating slots to the left and right of the scale).



3. Plug the 9-pin cable into both the SuperTrickler and the scale; finger-tighten all the locking screws firmly. This is the communications & scale power source – if the scale standard power supply is attached, please remove it.

4. Plug the SuperTrickler's power supply unit in and turn it on. This will power up the SuperTrickler and power up the scale in warm up mode.

5. By default the SuperTrickler will start up with the scale in warm up mode. However, so that we can program the scale, we must first bypass the warmup timer and turn the scale on fully via the SuperTrickler.

6. When the SuperTrickler is first powered up, it will display a splash screen showing the firmware version number for a few seconds. It will then display the warm-up screen, giving instructions to ensure the scale plate is clean and clear.

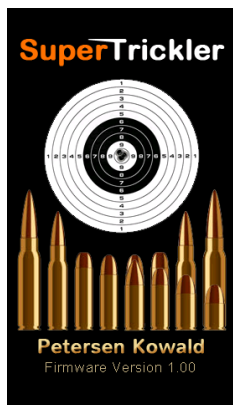

7. Touch anywhere on the Clean & Clear screen to take you to the Main Menu.

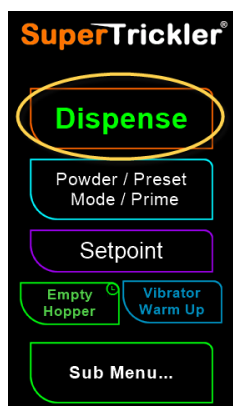

8. Touch the Start button to take you to the charging screen.

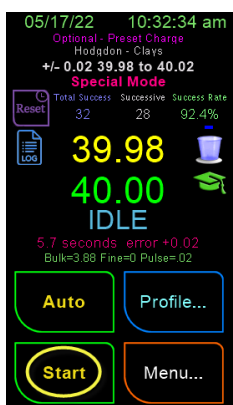

9. Touch the Start button to override the warmup timer.

10. Once the warmup timer has been overridden, the scale may be fully turned on and ready for programming. If the scale is not on, then press the ON-OFF button on the scale to turn on the scale.

11. The correct configuration is critical for communications and optimisation of the data exchange between the SuperTrickler and the scale. If your scales were supplied with your SuperTrickler, it will

be pre-programmed, and you can skip the follow section and continue at 'Testing the communications'.

11. Should your scale display an error **-E** then continue else you can skip down to 'Programming the Scale' section below. (**Note:** For FZ series scales, just press the  button on the scale)

12. The error is due to a considerable weight difference between the standard plate and the one used by the SuperTrickler and there for we must recalibrate the scale before we can program the scale. You will need a 100 gram precision standard weight for this process.

13. On the scale, press the  button for 2 seconds and the display should read **cal 0** after you remove your fingers.

14. Press  to set the zero and the display should change to **100**

15. Place a 100 gram weight on the new SuperTrickler plate

16. Press  and wait for the display to read **end**

17. Remove the 100 gram weight and the scale should display **0.000**

### Programming the Scale

This one-time procedure is required to configure your precision balance to communicate with the SuperTrickler and to operate in the most practical way for precision charge loading.

If the scale programming is factory standard, then follow the steps below. If your scale has a nonstandard configuration to suit another device, refer to the 'Scale Table of Changes' below to compare and change your configuration. You may also perform a full factory reset on your scale's settings. Refer to the section below or your scale's manual, section 9.2, titled 'Initializing the Balance.'





**Please note:** The following is a guide only. A&D may occasionally make firmware changes that result in slight alterations to the menus and parameters. See the table further down for all the correct settings that need to be modified. The procedure is the same, stepping through each section of the menus.







### Scale Factory Reset

You MAY choose to do this to get your scale back to a known state. It will reset ALL settings.















To perform a factory reset: YOUR SCALE SHOULD BE OFF TO START THIS PROCEDURE













| Steps | Button  | Instruction                | Display | Information                                      |
|-------|---|----------------------------|---------|--|
| 1     | On/OFF  | To turn the scale OFF      |         | Display off, just the little arrow in lower left |
| 2     |  | Press <b>BOTH and HOLD</b> |         | While holding, go to next step                   |
| 3     | ON/OFF  | Press ON/OFF               | PS      | Scale displays PS                                |
| 4     |  | Press <b>SAMPLE</b>        | CLr     | Scale displays CLr                               |
| 5     |  | Press <b>PRINT</b>         | CLr no  | To cancel, press <b>CAL</b>                      |
| 6     |  | Press <b>RE-ZERO</b>       | CLr Go  | Changes to Go/Yes                                |
| 7     |  | Press <b>PRINT</b>         | End     | Scale reset!                                     |

## Programming Buttons





|   |  |
|---|--|
|  | To enter the configuration menu, press and hold for 2 seconds. This button is also used to scroll between classes (areas) and item parameters. |
|  | Changes the parameters (setting).  |
|  | When a class is displayed, moves to an item in the class. When an item is displayed, store the new parameter and display the next class.       |
|  | Exits the configuration mode.  |

**Note:** Your scale firmware version may be slightly and as such may not be exactly as shown. When pressing the step through button (SAMPLE or RE-ZERO) if the display is not shown as per the readout information press repeatedly until it does.

| Steps | Button  | Instruction   | Display        | Information  |
|-------|---|---|----------------|--|
| 1     |   | Press <b>SAMPLE</b> for 2 seconds (applies to make any changes) | <b>bA5Fnc</b>  | Enter configuration menu<br>Base Function          |
| 2     |  | Press <b>PRINT</b>  | <b>Cond</b>    | Enter the class<br>Condition is the first option   |
| 3     |  | Press <b>RE-ZERO</b> 2 times                                    | <b>0</b>       | 0 = Fast response                                  |
| 3     |  | Press <b>SAMPLE</b> 4 times                                     | <b>5Pd</b>     | Display refresh rate                               |
| 4     |  | Press <b>RE-ZERO</b> 2 times                                    | <b>2</b>       | 2 = 20 time/second                                 |
| 5     |  | Press <b>PRINT</b>  |                | Save & enter next class                            |
| 6     |  | Press <b>SAMPLE</b> 3 times                                     | <b>dout</b>    | Data output  |
| 7     |  | Press <b>PRINT</b>  |                | Enter the class                                    |
| 8     |  | Press <b>RE-ZERO</b> 3 times                                    | <b>3</b>       | 3 = Stream mode                                    |
| 9     |  | Press <b>PRINT</b>  | <b>END/5iF</b> | Save & enter next class<br>(Flashes End, then SiF) |
| 10    |  | Press <b>PRINT</b>  | <b>bP5</b>     | Baud Rate  |
| 11    |  | Press <b>RE-ZERO</b> 3 times                                    | <b>5</b>       | 5 = 19.2 (19200 baud rate)                         |
| 12    |  | Press <b>SAMPLE</b>   | <b>btPr</b>    | Data Bits Parity Bit                               |
| 13    |  | <i>If this is not zero, press <b>RE-ZERO</b> until it is 0.</i> | <b>0</b>       | 7 Bits, Even (default)                             |

|    |   |   |             |                             |
|----|---|---|-------------|-----------------------------|
| 14 |    | Press <b>SAMPLE</b>                                     | <b>CrLf</b> | Terminator (serial string)  |
| 15 |    |   | <b>1</b>    | 1 = CR Carriage Return only |
| 16 |    | Press <b>SAMPLE</b>                                     | <b>tYPE</b> | Serial data format type     |
| 17 |    | Press <b>RE-ZERO</b> 4 times                            | <b>4</b>    | 4 = NU (number format)      |
| 18 |    | Press <b>PRINT</b>                                      |             | Save & enter next class     |
| 19 |    | Press <b>SAMPLE</b>                                     | <b>Alt</b>  | Skips over this section     |
| 20 |    | Press <b>PRINT</b>                                      | <b>Vnit</b> | Units                       |
| 21 |    | Press <b>SAMPLE</b> 10 times or until <b>GN</b> appears | <b>GN</b>   | Grains                      |
| 22 |    | Press <b>RE-ZERO</b>                                    |             | Save as primary units       |
| 23 |   | Press <b>SAMPLE</b> 2 times or until <b>g</b> appears   | <b>g</b>    | Grams                       |
| 24 |  | Press <b>RE-ZERO</b>                                    |             | Save as secondary units     |
| 25 |  | Press <b>PRINT</b><br>(applies to any changes)          |             | Save & enter next class     |
| 26 |  | Press <b>CAL</b><br>(applies to any changes)            |             | Edit the configuration      |

To set the scale for a 50 gram precision standard weight.

| Steps | Button  | Instruction                    | Display        | Information             |
|-------|---|--------------------------------|----------------|-------------------------|
| 1     |  | Press <b>Cal</b> for 2 seconds | <b>cal 0</b>   | Calibration             |
| 2     |  | Press <b>SAMPLE</b>            | <b>100.000</b> | 100 gram weight         |
| 3     |  | Press <b>Mode</b>              | <b>50.000</b>  | 100 gram weight         |
| 4     |  | Press <b>PRINT</b>             | <b>cal 0</b>   | Save change             |
| 5     |  | Press <b>Cal</b>               |                | Exit calibration change |

### Scale Table of Changes

The following table shows the changes to the standard configuration. If you are unsure of the settings or should your scale have a nonstandard configuration to suit another device, please check the settings against this table. Check that all settings are as per the settings marked in yellow and unmarked settings are the factory defaults.

| Class                            | Item and Parameter           | Description                                  |   |      |  |  |
|----------------------------------|------------------------------|--|---|------|--|--|
| bRSFnc<br>Environment<br>Display | [ond<br>Condition            | 0  | Fast response, sensitive value                                    | FAST | With "HoLd 1", sets the averaging time.  |  |
|                                  |                              | 1  |   | MID  |  |  |
|                                  |                              | 2  | Slow response, stable value                                       | SLOW |  |  |
|                                  | St-b<br>Stability band width | 0  | Stable range is ±1 digit  |      |  | The stabilization indicator illuminates when the display fluctuation is within the range. With "HoLd 1", sets the stabilization range. |
|                                  |                              | 1  |   |      |  |  |
|                                  |                              | 2  | Stable range is ±3 digits   |      |  |  |
|                                  | HoLd<br>Hold function        | 0  | OFF   |      |  | Holds the display when stable in animal mode. With "HoLd 1", [ANIMAL] turns on.  |
|                                  |                              | 1  | ON  |      |  |  |
|                                  | trc<br>Zero tracking         | 0  | OFF   |      |  | Keeps zero display by tracking zero drift.   |
|                                  |                              | 1  | Normal  |      |  |  |
|                                  |                              | 2  | Strong  |      |  |  |
|                                  | SPd<br>Display refresh rate  | 0  | 5 times/second  |      |  | Period to refresh the display  |
|                                  |                              | 1  | 10 times/second   |      |  |  |
|                                  |                              | 2  | 20 times/second   |      |  |  |
| Pnt<br>Decimal point             | 0                            | Point (.)                                    |   |      | Decimal point format   |  |
|                                  | 1                            | Comma (,)                                    |   |      |  |  |
| P-on<br>Auto display-ON          | 0                            | OFF  |   |      | Turns on the weighing mode display when the AC adapter is connected.             |  |
|                                  | 1                            | ON   |   |      |  |  |
| P-off<br>Auto display-OFF        | 0                            | OFF  |   |      | Turns off the display after 10 minutes of inactivity.                            |  |
|                                  | 1                            | ON (10 minutes)                              |   |      |  |  |
| rnG<br>Display at start          | 0                            | Displays                                     |   |      | Select whether or not to display the minimum weighing value at weighing start.   |  |
|                                  | 1                            | Does not display                             |   |      |  |  |
| bEEP<br>Beep                     | 0                            | Does not sound                               |   |      | Select whether or not to sound the beep when operating on keys.                  |  |
|                                  | 1                            | Sounds                                       |   |      |  |  |
| [L Add *<br>Clock                |                              | Refer to "10-9 Clock and calendar function". |   |      | Confirms and sets the time and date. The time and date are added to output data. |  |
| [P Fnc<br>Comparator             | [P<br>Comparator mode        | 0  | No comparison   |      |  |  |
|                                  |                              | 1  | Comparison, excluding "near zero" when stable value or overloaded |      |  |  |
|                                  |                              | 2  | Comparison, including "near zero" when stable value or overloaded |      |  |  |
|                                  |                              | 3  | Continuous comparison, excluding "near zero"                      |      |  |  |
|                                  |                              | 4  | Continuous comparison, including "near zero"                      |      |  |  |
|                                  | bEP-<br>LO buzzer            | 0  | OFF   |      |  |  |
|                                  |                              | 1  | ON  |      |  |  |
|                                  | bEP-<br>OK buzzer            | 0  | OFF   |      |  |  |
|                                  |                              | 1  | ON  |      |  |  |
|                                  | bEP-<br>HI buzzer            | 0  | OFF   |      |  |  |
| 1                                |                              | ON   |   |      |  |  |

|                             |                                 |   |   |  |
|-----------------------------|---------------------------------|---|---|--|
| $CP_{Hi}$<br>Upper limit    |                                 |   |   |  |
| $CP_{Lo}$<br>Lower limit    |                                 |   |   |  |
| $dout$<br>Data output       | $Prt$<br>Data output mode       | 0   | Key mode  | Accepts the <b>PRINT</b> key only when the display is stable.  |
|                             |                                 | 1   | Auto print mode A (Reference = zero)                                | Outputs data when the display is stable and conditions of $RP-P$ , $RP-b$ and the reference value are met.           |
|                             |                                 | 2   | Auto print mode B (Reference = last stable value)                   | Outputs data continuously.   |
|                             |                                 | 3   | Stream mode   | Accepts the <b>PRINT</b> key regardless of the display condition.  |
|                             |                                 | 4   | Key mode B (Immediately)  | Accepts the <b>PRINT</b> key immediately when the display is stable, or waits for the display to be stable when not. |
|                             |                                 | 5   | Key mode C (When stable)  | Uses interval output mode.   |
|                             | $RP-P$<br>Auto print polarity   | 0   | Plus only   | Displayed value > Reference  |
|                             |                                 | 1   | Minus only  | Displayed value < Reference  |
|                             |                                 | 2   | Both  | Regardless of displayed value  |
|                             | $RP-b$<br>Auto print difference | 0   | 10 digits   | Difference between reference value and displayed value   |
|                             |                                 | 1   | 100 digits  |  |
|                             |                                 | 2   | 1000 digits   |  |
|                             | $int$<br>Interval time          | 0   | Every measurement   | Interval time for the interval output mode (With $Prt$ 5)  |
|                             |                                 | 1   | 2 seconds   |  |
|                             |                                 | 2   | 5 seconds   |  |
|                             |                                 | 3   | 10 seconds  |  |
|                             |                                 | 4   | 30 seconds  |  |
|                             |                                 | 5   | 1 minute  |  |
|                             |                                 | 6   | 2 minute  |  |
|                             |                                 | 7   | 5 minute  |  |
|                             | $S-id$<br>ID number output      | 0   | No output   | Selects whether or not the ID number is output.  |
|                             |                                 | 1   | Output  |  |
|                             | $S-t d^*$<br>Time/Date output   | 0   | No output   |  |
|                             |                                 | 1   | Time only   |  |
|                             |                                 | 2   | Date only   |  |
|                             | $PUSE$<br>Data output pause     | 0   | No pause  | Selects the data output interval.  |
|                             |                                 | 1   | Pause (1.6 seconds)   |  |
|                             | $Rt-F$<br>Auto feed             | 0   | Not used  | Selects whether or not automatic feed is performed.  |
|                             |                                 | 1   | Used  |  |
|                             | $info$<br>GLP output            | 0   | No output   | Selects GLP output method.   |
|                             |                                 | 1   | AD-8121 format  |  |
|                             |                                 | 2   | General data format (output time and date using the built-in clock) |  |
| 3                           |                                 | General data format (output time and date using the dock of the external equipment) |   |  |
| $Rr-d$<br>Zero after output | 0                               | Not used  | Adjusts zero automatically after data is output                     |  |
|                             | 1                               | Used  |   |  |

|                                       |  |   |   |   |
|---------------------------------------|--|---|---|---|
| SIF<br>Serial<br>interface            | bPS<br>Baud rate                               | 0   | 600 bps   |   |
|                                       |  | 1   | 1200 bps  |   |
|                                       |  | ▪ 2   | 2400 bps  |   |
|                                       |  | 3   | 4800 bps  |   |
|                                       |  | 4   | 9600 bps  |   |
|                                       |  | 5   | 19200 bps   |   |
|                                       | btPr<br>Data bit, parity bit                   | ▪ 0   | 7 bits, even  | Please Check  |
|                                       |  | 1   | 7 bits, odd   |   |
|                                       |  | 2   | 8 bits, none  |   |
|                                       | ErLF<br>Terminator                             | ▪ 0   | CR LF   | CR: ASCII code 0Dh<br>LF: ASCII code 0Ah                |
|                                       |  | 1   | CR  |   |
|                                       | tYPE<br>Data format                            | ▪ 0   | A&D standard format   | Refer to "10.6. Description of the Item "Data Format"". |
| 1                                     |  | DP format   |   |   |
| 2                                     |  | KF format   |   |   |
| 3                                     |  | MT format   |   |   |
| 4                                     |  | NU format   |   |   |
| 5                                     |  | CSV format  |   |   |
| t-UP<br>Timeout                       | 0  | No limit  | Selects the wait time to receive a command.                             |   |
|                                       | ▪ 1  | 1 second  |   |   |
| ErEd<br>AK, Error code                | ▪ 0  | No output   | AK:ASCII code 06h   |   |
|                                       | 1  | Output  |   |   |
| nLt<br>Programmable-unit (Multi-unit) | Sets an arbitrary coefficient.                 |   | Available only when programmable- unit mode is selected.                |   |
| Unit<br>Unit                          | Refer to "5. WEIGHING UNITS".                  |   |   |   |
| id<br>ID number                       | Refer to "11. ID NUMBER AND GLP REPORT"        |   |   |   |
| AP Fnc<br>Application                 | APF<br>Application function                    | ▪ 0   | Normal weighing mode  |   |
|                                       |  | 1   | Capacity indicator  |   |
|                                       |  | 2   | Statistical calculation mode  |   |
|                                       | StAF<br>Statistical function mode output items | ▪ 0   | Number of data, sum   |   |
|                                       |  | 1   | Number of data, sum, maximum, minimum, average, range (maximum-minimum) |   |
|                                       | 2  | Number of data, sum, maximum, minimum, average, range (maximum-minimum), standard deviation, coefficient of variation                 |   |   |
|                                       | 3  | Number of data, sum, maximum, minimum, average, range (maximum-minimum), standard deviation, coefficient of variation, relative error |   |   |
| LocFnc                                | PASS   | ▪ 0   | OFF   | Refer to "14. PASSWORD LOCK FUNCTION".                  |
|                                       |  | 1   | ON (limits weighing operations)   |   |
|                                       |  | 2   | ON (enables basic weighing)   |   |
|                                       | Loc na   | AdmIN   | Administrator password input  |   |
|                                       |  | USEr01  | User 1 password input   |   |
|                                       |  | ~<br>USEr10   | User 10 password input  |   |

\* : Only for the FZ-i /FZ-iWP /FZ-GD series    ▪ : Factory settings.

## Testing the communications

If the SuperTrickler is still warming up, or on the warmup ready screen, simply touch the screen to get the main menu.

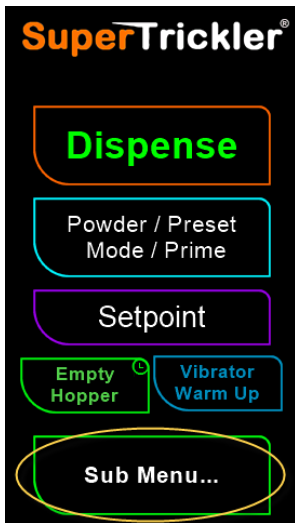

press the **[Sub Menu's]** button,  
then the **[System...]** button,  
then the **[Peripherals...]** button,  
then the **[Scales / Balance]** button.

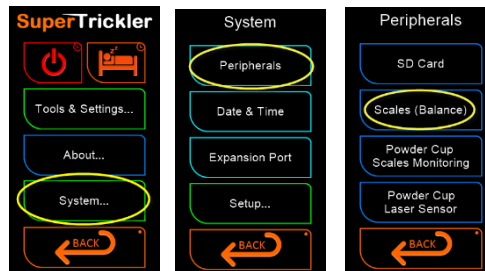

If communications are successful, you should see a screen similar to this.

Applying a small force to the scale plate should duplicate the scale value on the SuperTrickler display.

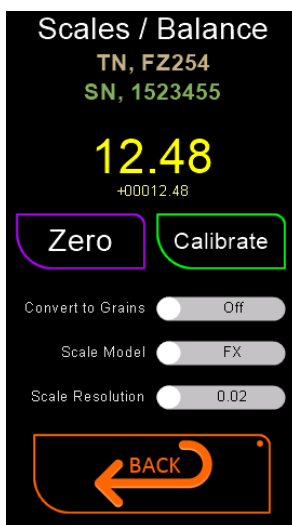

In the unlikely event that communications are not established, please check the serial communications setup/programming and the cable for damage or correct installation.

In the event unlikely event that you are unable to establish communications please contact your local dealer or our support email [support@supertrickler.com.au](mailto:support@supertrickler.com.au) (please allow up to a few days for the support team to respond as this service is not manned 24/7).

If communications are working, the systems should autodetect if you have a FZ series scale and choose the appropriate mode for calibration. If it does not, you may have to turn it on using the FZ Internal Calibration Mode button.

## Level & Calibrate the scale

At this point, it is recommended to place the scale on a solid base, level it, and calibrate it as per the installation and calibration guide in the A&D Precision Balance manual. Alternatively, you can use the SuperTrickler's calibration interface button on the Scales / Balance screen.

**Note:** A 50 or 100-gram precision weight will be required. It is recommended that the precision weight not be touched with bare skin and should be handled and placed with great care.

## Setting the clock

Before we have some fun, let's set the clock so that data logging and records will be accurate.



From the main menu press the **[Sub Menu]**'s button, then the **[System...]** button, then the **[Date & Time...]** button.

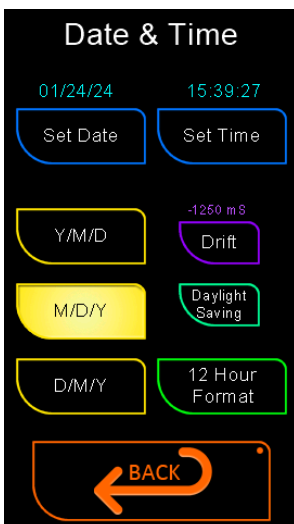
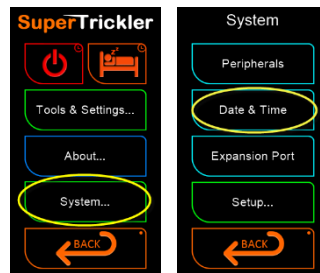

First select your preferred 'yellow' Date Format button, then your preferred 'green' 12- or 24-hour time format, then the 'Aqua' daylight saving button should your area currently be in daylight saving time.

Now press the 'blue' **[Set Date]** button to set the current date, then the 'blue' **[Set Time]** button to set the current time.

When completed, press the **[Back]** button 3 times to get back to the main menu.

For additional information also see: [System](#) / [Date & Time](#)



## Filling and Emptying the Gunpowder Hopper.

When changing powder, be sure that any spilled powder is removed from the scale and all the powder is removed from the SuperTrickler before new powder is added. Never mix different gunpowder.

### Filling

It is not recommended to load the hopper with more powder than is approximately required. You may choose to use a short funnel in the gunpowder hopper opening to aid the process.

1. Ensure the Micro SD card is installed, to stop any spilled powder entering the electronics bay.
2. Pour only smokeless gunpowder into the hopper. Do not fill the powder past the opening of the hopper.
3. If a short funnel was used, it may remain in the hopper if so desired.

### Emptying

You do not need to turn off or unplug the SuperTrickler to carry out this operation. You may also prefer to empty into a catching bowl, or you can empty the gunpowder directly into the original container with the aid of a funnel.

**Note:** The rotating bulk tube must remain in the SuperTrickler while emptying it.

1. Ensure the Micro SD card is installed.
2. REMOVE THE POWDER CUP.
3. Gently lift the SuperTrickler up from the scale (do not lift the scale). The cables are long enough to allow reasonable mobility of the SuperTrickler, but do not manipulate it to the point where it is tugging on the connections.
4. Tilt the SuperTrickler backwards to around 45° to expose the bottom and the hopper gate.
5. Place the SuperTrickler over a catch bowl or directly over the original container with a funnel.
6. Open the hopper gate fully and the gunpowder will begin to flow out.
7. Once no more powder is flowing, close the hopper gate and keep the unit angled backwards to around 45°.
8. Rotate the large bulk tube clockwise several times by hand, while gently shaking the SuperTrickler. Be careful not to touch the top vibrating tube (this needs no additional purging process).
9. Then again, repeat the process of opening the hopper gate to release the powder into the catch bowl or original container until no more powder flows.
10. Close the hopper gate and place it back onto the scale, ensuring that it is aligned and seated properly. **Note:** The SuperTrickler is designed so it cannot be seated back on the scale unless the hopper gate is fully closed.

**Warning:** Do not force SuperTrickler onto the scale. If the hopper gate is not fully closed, you may damage your scale.

## Quick Start – let’s have some fun.

The **SuperTrickler** is not like other automatic dispensers in its operation or characteristics. Please read the entire manual to gain a full understanding of how it works and to get the most benefit from your investment.

**Important:** Do not load any bullets with powder dispensed by the SuperTrickler until you have read and understood this owner’s manual.

We understand it’s nice to familiarize yourself with the device before diving into the comprehensive manual. So let’s begin by loading the hopper with gunpowder, then selecting a powder and dispensing a charge.

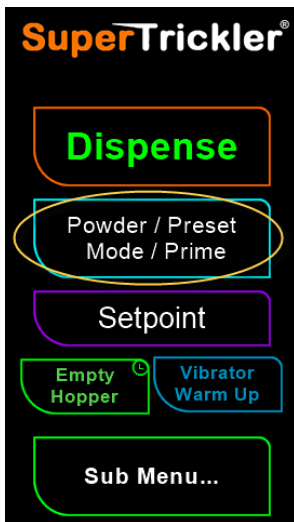

From the main menu press the **[Power / Preset / Mode / Prime...]** button, then again, the **[Powder...]** button, then the **[Select...]** button, find the powder brand in the list – use the scroll **[Next]** & **[Back]** button to find more selections. Once the powder brand has been found, press that button to select the type of powder in the same manner.

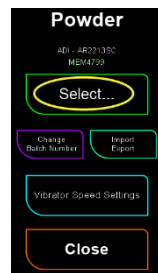

If you like, you can also enter the powders batch number for the record.

After selecting a powder, press **[Back]** two or three times to get back to the main menu.

From the main menu, press the **[Setpoint]** button to set the desired charge – this will take you directly to the dispensing screen.

The scale value is shown in yellow, and the charge set point is shown in green.

## Vibrator Speed Settings

You will see the **Profile** button flashing, indicating that something needs attention—in this case, it is the vibrator speed settings.

Press **[Profile...]** and the system will take you directly to the vibrator speeds screen (normally pressing the Profile button takes you to the main profile screen).

**Very Important:** The correct setup of the vibrator speed settings is critical. Failure to do this correctly may result in the artificial intelligence self-learning being unable to achieve stable results.

Each powder and preset will need to have the vibrator settings calibrated to suit the powder characteristics. If you learn nothing else, you must learn how to complete this task correctly. I recommend you read the **Vibrator Speed Settings** in detail, located under the profile section.

## Vibrator Base Speed

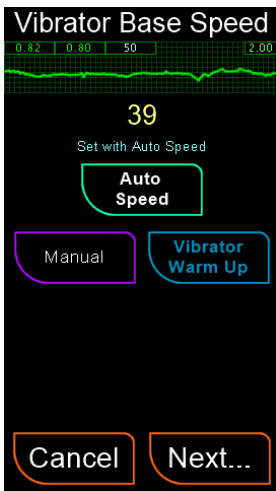

The adjustment range available is between 1 and 255 units. This value represents 1% speed for all the vibrating instruments.

**STEP 1.** Ensure the hopper has an adequate amount of powder and the powder cup is in position under the trickler tubes.

**STEP 2.** Press the 'Auto Speed' button; this will initiate an operation that will start the vibrator tube. Initially ramping up and priming the tube and then it will begin reducing the speed until the flow rate is around the 1 or 2 seconds between kernel drops. Wait for the system to stop by itself.

**STEP 3.** Once step 2 has been completed the system will automatically take you to the next screen to set the Vibrator High Speed Limit.

## Vibrator High Speed Limit

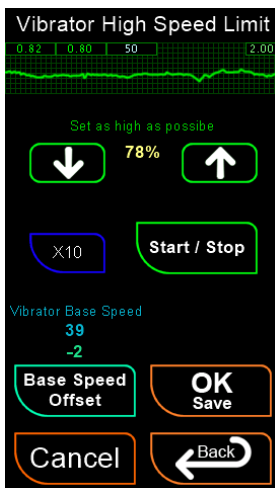

The job of the vibrator high speed limit is exactly what it says: to limit the speed that any of the vibrator instruments can go. This setting has a range between 1 to 100%.

The reason we have a limit is to prevent running the vibrator too fast, which may result in powder bouncing out of the cup and creating a mess and inaccurate readings from the scale. The ideal smooth flow rate is around 0.10 - 0.12

**STEP 4.** Press the Start/Stop button to start the vibrator and adjust the vibrator high speed limit up or down, such that it is going as fast as possible without powder jumping out of the cup. The ideal smooth flow rate is around 0.10 - 0.12. You can use the BLUE range key to change the arrow steps from X1 and X10 per step.

**STEP 5.** Once you are happy with the setting (and this maybe 100%) then press Start/Stop again to stop the vibrator motor.

**STEP 6.** Press OK Save to record the settings and return to the profile main screen.

**STEP 7.** Again, press OK Save to save the profile settings and return to the dispensing screen.

**NOTE:** Temperature and other factors can change the vibration characteristics, so you can revisit these settings as often as you like (see vibrator settings on the profile main screen).

Press the main profile button OK Save button to return to the dispensing screen.

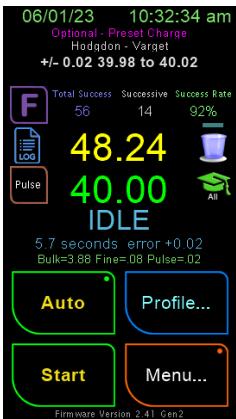

Place an empty powder cup on the scale plate.

Press the **[Auto]** button if you like (this will save hitting start for every run).

Then press Start.

The **SuperTrickler** will begin trying to dispense powder. However, the trickler tubes will most likely be un-primed (we will learn how to do this later), so you may find that after about 5 seconds, a **DISCARD** error will appear with a “No Weight Detected” message. Just press **Start** again and repeat until the powder begins to flow from the bulk tube.

As there is no profile, nothing is known about the characteristics of the powder.

At this stage, the simplest solution is to let the Artificial Intelligence (AI) work it out by trial and error. The first several attempts will most likely fail as the AI discovers the powder’s dynamics. All loads can simply be poured back into the powder hopper.

After a few tries, the AI will have figured out the powder dynamics and will continue to do so until (by default) 10 successful charges have been produced in a row. Then the self-learning will be disabled, and the little scholar’s hat will disappear from the dispensing screen.

Congratulations—you just discovered how easy the SuperTrickler is to use! Had the scale been warmed up correctly, levelled, and calibrated, your load would be good to go.

**Legal Reminder:** Do not load any bullets with powder dispensed by the SuperTrickler until you have read and understood this owner’s manual.

### The trade-off between speed and failures.

Powder and granules are notoriously difficult to dispense. Given enough time, you can slowly trickle the powder for an accurate charge every time. However, is this the best approach?

**The Trade-off:** You can go fast and have a few failures every now and then, or go slow and rarely have a failed charge. We are all different, so the choice is yours. You may prefer to charge fast and discard overcharges, or you may prefer to charge slower and rarely discard overcharges.

Do not expect 100% successful charges unless you are willing to trade dispensing speed for time.

For example, if you were to do 100 charges with no failures, but each charge took 20 seconds, the total time would be 33 minutes and 20 seconds.

Now, let’s look at the same scenario if each charge took only 6 seconds, but with a 1 in 10 failure rate. The total time would be 11 minutes, a saving of 22 minutes and 20 seconds.

Even if the charge time were 10 seconds, with a 1 in 10 failure rate, the total time would still only be 18 minutes and 20 seconds. This is a 15-minute saving in time for the sake of a few rejected overshoots.

Do not be concerned with a few overshoots if you can save considerable time, but the decision is yours.

User Notes...

## Menu System

The menu system is based around workflow and practical application. It is broken down into 3 main sections: Dispensing, Operational, and System.

1. *Dispensing* is the main functionality of the SuperTrickler, and as such, the core requirements are directly accessible from the main menu.
2. *Tools and settings* is the "Operational" menu with all the general functionality and options that an operator may require.
3. *System* is the deeper functionality; configure, restore, and test.

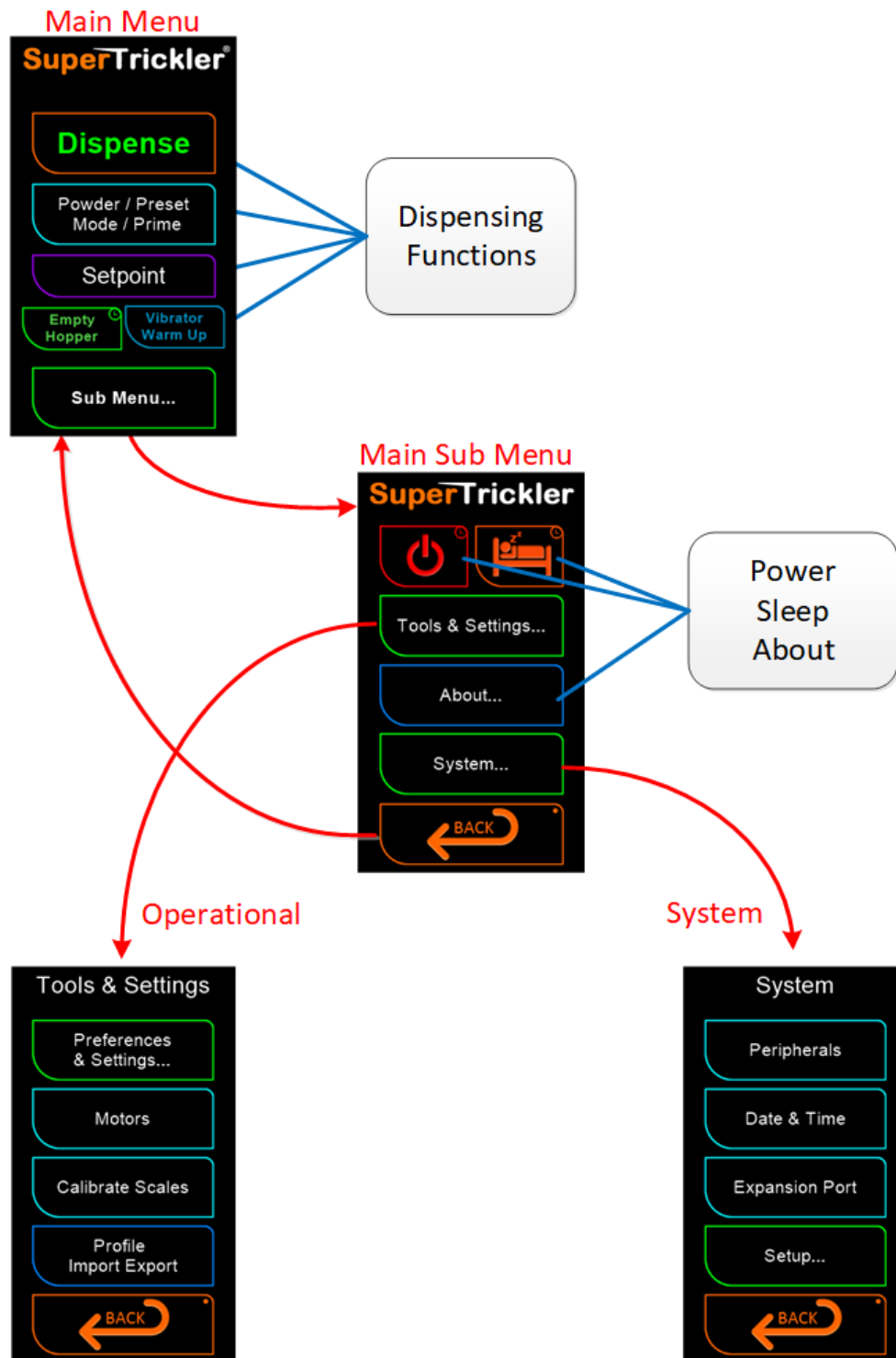

## Special Buttons.

There are several types of special buttons that you find throughout the system.

### Hold to activate

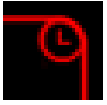

Any button in the system that has a small clock in the top right-hand corner will need to be held in for a time before activation will occur. This feature is designed to ensure that these particular buttons are not accidentally hit, causing unintentional activation. The green work light will flash once timed out.

### Quick Return



Some buttons and many of the back buttons will have a dot in the top right-hand corner. This indicates that the button is a quick navigate button and works as follows...

- Pressing the button normally (finger on, finger off quickly) will return you back to the previous menu.
- Pressing and holding the back button for around 1 seconds will navigate you directly to the dispensing screen
- Other button will take you to a convenient location.  
See notes on the button descriptions for its alternate use.

### Artificial intelligence Self-Learning



Any button in the profile that has the AI icon in the bottom right-hand corner, signifies that this control can be changed by the AI self-learning.

## Main Sub Menu

Called from the Main Menu, the main submenu is the gateway to the many functions and features of the SuperTrickler.

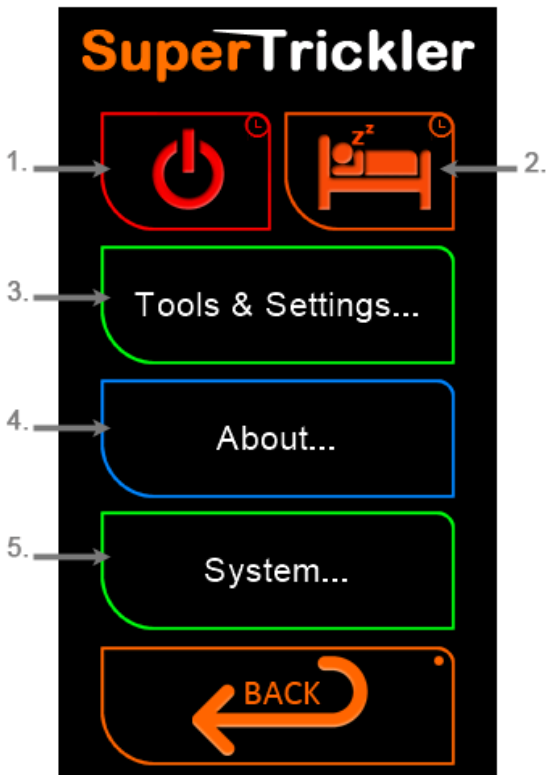

1. Power down turns off power to the scale and puts the SuperTrickler into hibernation. To reactivate the power, simply touch the blank screen.

2. Sleep will turn off the scale display but leaves the power on to keep the scale in a ready state, while the SuperTrickler goes into hibernation. To reactivate the system, simply touch the blank screen.

3. [Tools & Settings...](#) will give access to the operational mainstream tools & settings menu.

4. [About...](#) will display information about the SuperTrickler, including the serial number and powder file version date. The QR code is an email link to [support@supertrickler.com.au](mailto:support@supertrickler.com.au)

5. [System...](#) will take you to many submenus, giving you access to such things as system setup, peripheral devices, the date and time and the expansion port setup.



## Soft keypads

The SuperTrickler has two soft keypad systems, designed to make entry clear and easy. The two keypads are a numeric keypad used to enter numeric data and the alphanumeric keypad that allows you to enter text.

### Numeric Keypad

Is the most used soft keypad, and is flexible in functionality. The numeric keypad has two flexible soft keys that will change according to the type of values being entered. An example of this is the entry of the date or time; where the spacer will change to '/' for dates and ':' for time. In the case of date and times the system will generally automatically populate the date and time spaces as required.

**Note:** Often the system will either limit you to an entry range, change, or automatically change the value if it's out of range.

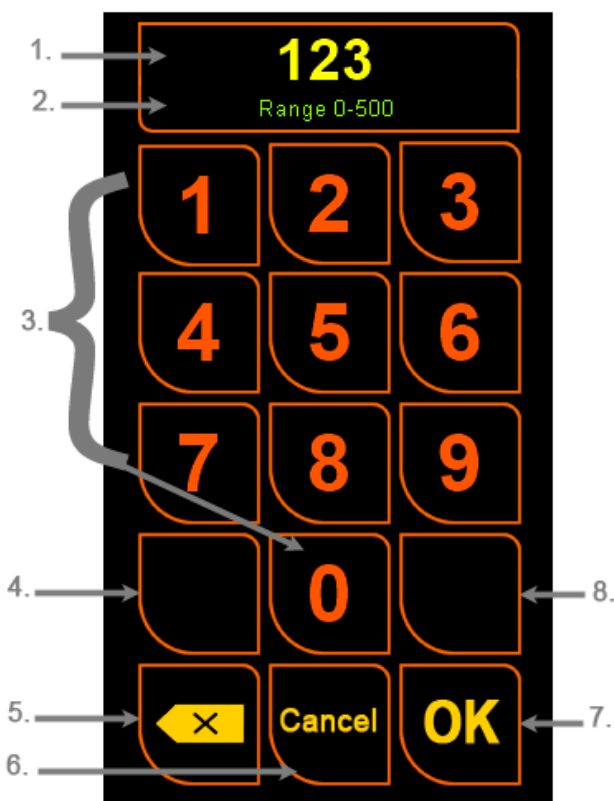

1. The entered value display.
2. Prompt display. This contains information relating to the value you are entering.
3. Number keys.
4. Left soft key. This can be blank or have the following functionality....
  - ± = Toggle the value between positive / negative
  - (+/-) = Add the entered amount to the existing value
  - am/pm = toggle between am and pm time.
  - OFF , a flag to disable the functionality of the device or option being edited.
5. Backspace.
6. Cancel the entry and exit.
7. Accept the entry and exit.
8. Right soft key. This can be blank or have the following functionality....
  - . = Decimal
  - / = Date spacer
  - : = Time spacer

## Alphanumeric Keypad

The alphanumeric keypad is designed to you allow to enter a text string of alphanumeric characters both in upper and lower case, punctuation and symbolic characters. Because of the limited size of the display, the alphanumeric keyboard is split into multiple sections, accessible by using the key range scroll buttons.

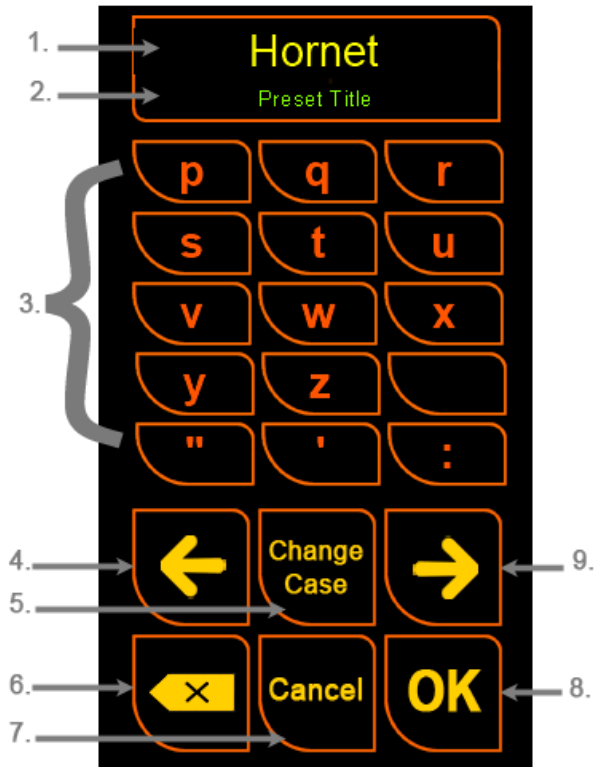

1. The entered text string display.
2. Prompt display. This contains information relating to what you are entering.
3. Text keys.
4. Key range scroll left.
5. Toggle the case of alphabetical keys.
6. Backspace.
7. Cancel the entry and exit.
8. Accept the entry and exit.
9. Key range scroll right.

## Vibrator Warmup Option

If desired, you can use this option to run the vibrator (at absolute full speed) without powder in order to warm up the rubber mount. This can lead to more stable operation. The warm-up process can be started and run on a background timer while other tasks are being carried out.

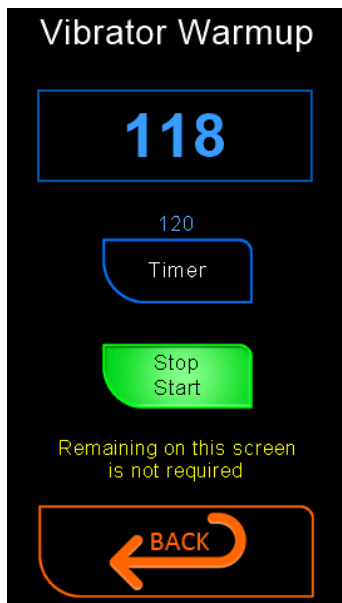

**WARNING:** To avoid a powder spill, ensure there is no powder in the hopper before running the warm-up.

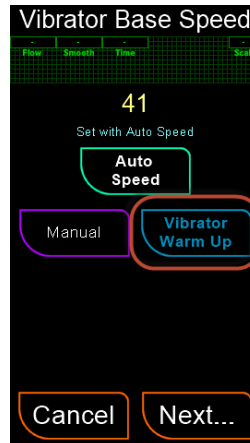

There are two access points to the warmup screen, the Main Menu or the Vibrator Base Speed screen.

## Dispensing

### From the Main Menu

The main menu is the central point of the system. The first three buttons represent the mainstream core of the dispensing functionality; selecting a powder, a set point and starting the dispensing.

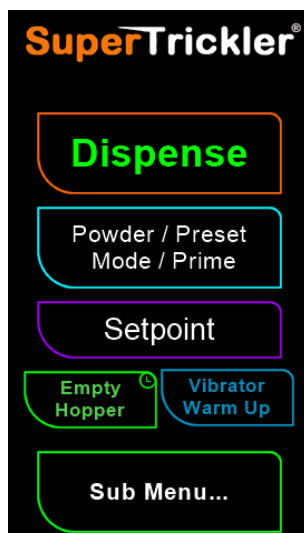

**Dispense:** will take you to the dispensing screen to begin the dispensing process.

**Powder / Preset / Mode / Prime...:** will take you to a submenu, allowing you to select the desired feature.

**Setpoint:** allows you to change the charge target set point (amount of powder in weight). Once the charge is set you will be taken directly to the dispensing screen.

**Empty Hopper:** Use this when emptying the unit of powder. It will prevent accidental pressing of buttons on the screen.

**Vibrator Warm Up:** Run the vibrator to warm up the mounting rubber.

## Dispensing Screen

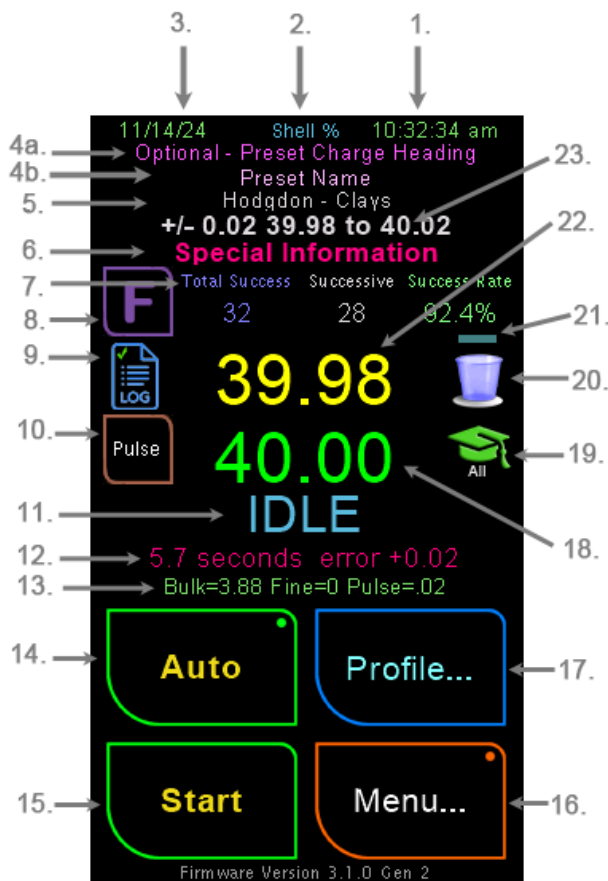

1. [Time](#).
2. Optional [pre-set](#) shell volume as percentage of the charge.
3. [Date](#).
- 4a. Optional [pre-set](#) charge Heading.
- 4b. Optional [pre-set](#) charge Name.
5. [Powder brand and type](#).
6. [Special mode](#) (ladder, top up or external) or other information.
7. Statistical Data
8. Function button for the quick access sub-menu.
9. Shows if [successful log](#) file enabled.
10. Optional Manual Pulse button, or if external control is enabled this will show the robot status.
11. Shows operational status.
12. Charge results, time and error amount.
13. Instrument meta data inflight or time amount after the charge.

14. Enable Automatic mode button

*\* Holding this button will take you directly to the Mode Menu screen.*

15. Start charge button.

16. Return to main menu button.

*\* Holding this button will take you directly to the Powder or the Preset selections screen, depending on the current selection type.*

17. [Powder profile](#) button.

*\* Touching this button will take directly to the Powder or the Preset selections screen, depending on the current selection type.*

18. Set point amount

*\* Touching this value will open the setpoint editor.*

19. Shows if [AI self-learning](#) is enabled and status by color.

20. Shows powder cup status, errors or instrument animation.

21. Shows if the [laser](#) is enabled and status by color (see Note below).

22. Scale Weight

23. [Tolerance level and tolerance range](#).

## Dispensing Screen Functionality.

In this manual the Dispensing screen may also be referred to as the charge screen or powder drop screen.

### General

**Notes:** When an instrument motor is running the cup display is replaced with a crosshair animated



image depicting the operation.

If the laser is enabled (item 21 above) its color has the following meaning: Hidden: Laser is not enabled. See System, Peripherals, Power Cup Laser Sensor.

**Blue or Grey:** Laser has not established a measurement.

**White:** No cup detected.

**Green:** Empty cup detected.

**Red:** Cup detected with some content.

If the Robot is showing (External Control is enabled) then the SuperTrickler will ONLY function if it has an external control connected. You can disable it in the Options menu. The Robot feature is only available when activated by a separate licence.

### Pulse Button

**Note:** There is an option to enable this button and control how the manual pulse button operates. This test assumes it is set to enabled (not the default) and set to 'Auto Quick Touch.'

The manual pulse button on the charge screen is the brown button just below the LOG icon. This button is optional and must be selected from the charge screen options menu. It operates according to the current pulse instrument settings.

A quick touch will activate the automatic pulse cycling until the weight changes.

Holding the **Pulse** button down will initiate the pulsing operation until the button is released.

### Function Sub-Menu (the F button)

The function (F button) will bring a sub-menu enabling you easy access to do the following...

- Reset the dispensing screen statistics.
- Reset the Hopper Powder Used (see below; hopper powder alert system)
- Select the type of meta data or instruments used information.

Any changes made to the settings on the function screen, will only be acted upon if the OK button is pressed, pressing cancel will ignore the changes and return you to the main dispensing screen.

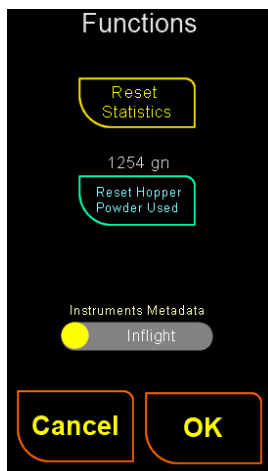

The **Statistics Reset** is used to reset the dispensing screen statistics. When you select the reset function, it will highlight as being selected but will not reset until **OK** is pressed, allowing the operator to deselect the function.

The **Reset Hopper Powder Used** is part of the Hopper Alert system (see below). This can be reset at any time. The value displayed is the current Hopper Alert Powder Used amount. The operation is identical to the above statistics reset.

The **Instrument Metadata Selection** has been moved from the submenu, options charge screen options to the function screen. This now makes changing the selection when fine-tuning quick and convenient. Again, to initiate the change, the **OK**

## Hopper Powder Alert System

This system will monitor the amount of powder used and will issue an alert when the target amount of powder has been used. The system is theoretical and does not directly monitor the powder in the hopper. The target value is set individually in each profile (preset or powder) under the More Settings....

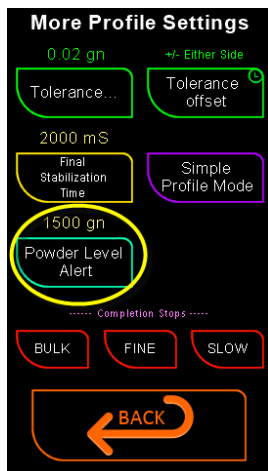

When a charge is successful, the powder used is added to the register. When the register reaches the value set by the profiles Powder Level Alert a warning will be issued, as the cup is removed from the pan.

The alert can be turned off by simply setting a value of zero or pressing the OFF key on the keypad.

The powder usage register is automatically reset at the start of each session, or when a new powder or preset is selected.

The value can also be reset manually at any time within the function menu on the charge screen or when the alarm is activated.

NOTE: From above, on the function screen, the current value is displayed, so that you can monitor the amount of powder used to determine when you notice a characteristic change in the dispensing behaviour.

Why does the dispensing behaviour change? Powder is granular. As a result, when the hopper is full, the weight of the powder compresses the grains at the bottom of the hopper and where the powder enters the vibrating and rotating tubes. With a full hopper, this compression is high, which reduces the flow properties of the powder. As the powder is used, the weight reduces and the powder begins to flow more rapidly. Eventually, the flow characteristics reach a point where they fall outside of the profile's controlling factors, and the number of overthrows increases.

The Hopper Powder Alert will activate when the threshold is reached, and the empty powder cup is returned. At this point Auto (if selected) is suspended and a warning screen will pop up with reset options.

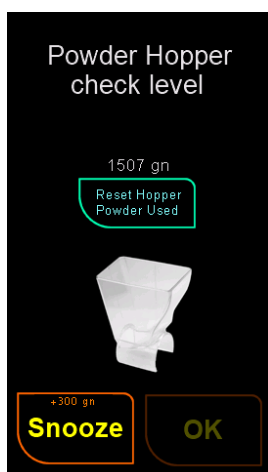

When the alarm pops up, you can select Snooze, this will add 300 grains to the target threshold. The alert will disappear, and normal operations will continue.

You can also top up the powder in the hopper and press the 'Reset Hopper Powder Used' this will intern enable the OK button to confirm the reset. This method assumes a fully topped up hopper and will continue operations until the powder used register again reached the target threshold.

**Remember:** Each target threshold must be set in the profile. The default for NEW profiles is set at 1500 grains and existing profiles should have a value of 0 or OFF.

## A guide to Hopper Volumes

- It takes approximately 700gr to cover the powder baffle at the bottom of the hopper.
- If the powder is 75mm or 3" below the top there is approximately 2000gr in the machine.
- f the powder is 50mm or 2" below the top there is approximately 4000gr in the machine.
- If the powder is 25mm or 1" from the top there is approximately 7000gr in the machine.

## Charge Setpoint

Setting the charge setpoint can be achieved by two methods and is a simple matter of entering the value into the keypad and pressing OK.

Method 1. Is from the main menu, pressing the **[Setpoint]** button.

Method 2. Is from the dispensing screen, by pressing the set point value field. See point 16 above.

## Selecting a Powder or Pre-set

From the main menu selecting **[Powder]** will take you to the selection screen, from where you can select either a powder or a pre-set.

## Powder & Pre-set Profile Database

The characteristics of every powder are different. The SuperTrickler has a database on the micro-SD card that keeps a record of every powder. Thus, the characteristic of a given powder is known the next time that powder is selected. The characteristics 'profile' for that powder will be loaded into the system. Where no profile has been recorded, the system will create a record using a default profile template.

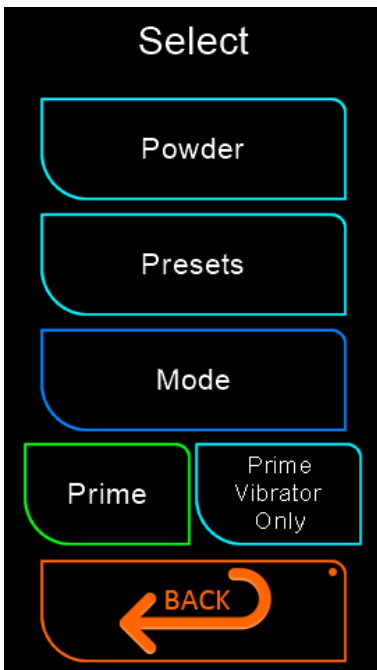

**Powder**: will take you to the Power selection menu.

**Pre-set**: will take you to the pre-set selection menu.

**Mode**: Will allow you select the mode of operation, Normal, Ladder or Top-up modes.

**Prime**: Standard, trickler tube priming function

**Prime Vibrator Only**: used to prime slow moving powders.

**NOTE**: It is highly recommended to prime a new powder before starting the charge by holding the **[Prime]** button, this will initiate a prime of both tubes for a short period of time then automatically turn off. **[Prime Vibrator Only]** will initiate a prime of vibrator tube only for a long time (45 seconds), this is sometimes required with slow moving powders.



## Selecting a Powder

Pressing the **[Powder]** button from the select menu takes you to the powder submenu.

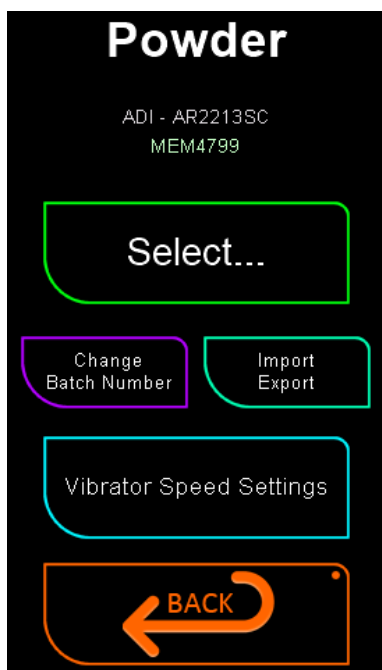

**Select:** will take you to an extensive list of powders currently on the market. The list is broken down into two sections: firstly, the powder brand (manufacture) and secondly, the powder type or name.

**Change Batch Number:** in some countries the recording of powder batch numbers and usage is a legal requirement. Also, it is not unusual for precision shooters to keep a record of the powder batch with their loads. The batch number is recorded in each powder's profile record.

**Import/Export:** Import/Export Powder profile for sharing or debugging. See [Import/Export section](#)

**Vibrator Speed Settings:** This will allow you to change the vibrating motor speed range. The actual speed range represents 1 to 100%.

**Important:** This must be set when an un-profiled powder is selected. See [Vibrator Speed Setting procedure](#).

**Note 2:** For the latest powder.dbl database go to the download area at:

<https://supertrickler.com.au>

Download the file and copy it to the root directory of the SuperTrickler's Micro SD card. Or you can edit the file yourself following the format of the file. If you would like something added, send an email to support ([support@supertrickler.com.au](mailto:support@supertrickler.com.au))

## Pre-set Charge Profile Database

The SuperTrickler allows for an unlimited number of pre-set charges to be added. The pre-sets are an extended profile of the powder profile, containing additional information and treated as a separate profile than that of the powder profiles. The pre-sets are organised as headings and under each heading a group of pre-set names. There is no limit to the number of headings and or pre-set names and are organised as in this example.

### Heading 1

Name 1  
Name 2  
Name 3  
.... (Unlimited Names)

### Heading 2

Name 1  
Name 2  
Name 3  
.... (Unlimited Names)

### Heading 3

Name 1  
Name 2  
Name 3  
.... (Unlimited Names)

.... (Unlimited Headings)

The additional fields held in a pre-set are as follows...

1. Pre-set Heading
2. Pre-set Name
3. Charge Set point.
4. The shell (cartridge) volume.

**Note 1:** The pre-set menus allow you to change the 'powder batch number', however, this information is not stored in the pre-set profile. Rather, it is stored separately, and shared with the Powder Profiles information. (Changing the batch number in either the powder profile or the pre-set profile, changes the same data.)

**Note 2:** An advantage of using a pre-set over a simple powder profile is that the volume of the cartridge (shell) can be recorded. When dispensing, the percentage of the volume used by the charge will be displayed and logged in the 'loads.csv' log file.

### Selecting a Preset profile

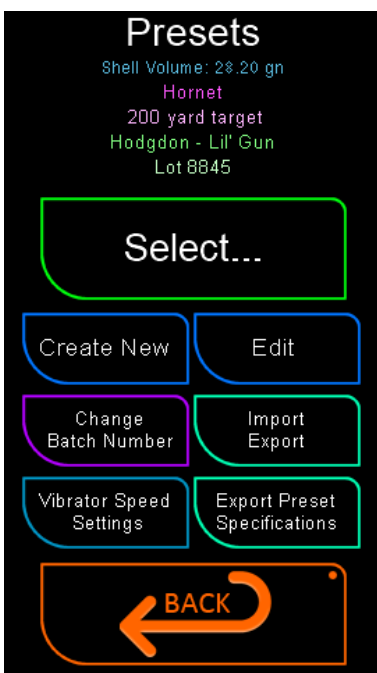

Pre-sets are an easy way to select common loads and (like the powder) is a simple list of headings and sub-headings. An example may be a heading of 'Hornet', then a sub-heading selection of '200-yard target'. Each Heading and Name can be up to 30 characters in length.

When you first create a pre-set, you must also select a powder brand and type. If the profile exists for the powder selection, then it will be copied into the profile of the pre-set, otherwise the default will be used.

**NOTE:** The pre-set profile will run its own profile and not the powder's profile; any changes to the pre-sets profile will not change the original powders profile; however, the powder batch number is linked to the powder's profile.

**Change Batch Number:** is common with the powder profile, changing the batch number here is identical to changing in the powder menu.

**Import Export:** Allows Importing/Exporting profiles. See [Import/ Export](#) for more details and cautions.

**Export Preset Specifications:** Creates a preset.csv file in the \log folder, that has a list of all your preset specifications; Date, Time, Heading, Name, Powder, Type, Setpoint, Tolerance & Volume.

**Vibrator Speed Setting:** This will allow you to change the vibrating motor speed range. The actual speed range represents 1 to 100%.

**Important:** This must be set when an un-profiled preset is selected. See [Vibrator Speed Setting procedure](#).

### Creating a new pre-set

There are several fields to populate when starting a new pre-set. Some of these fields can be selected from existing headings or can be created from scratch using the alphanumeric keypad.



#### NOTE:

1. Heading is prefilled, or enter a new one
2. Charge Name is required.
3. A powder brand and type must be selected.
4. The shell (cartridge) volume is optional.
5. Enter the desired Setpoint for the charge

### Editing a Pre-set

To edit pre-set, select the field that requires changing. When selecting a new powder; if the profile exists for the selected powder that profile's key values will populate the pre-set and if no profile exists then the default profile will be used.

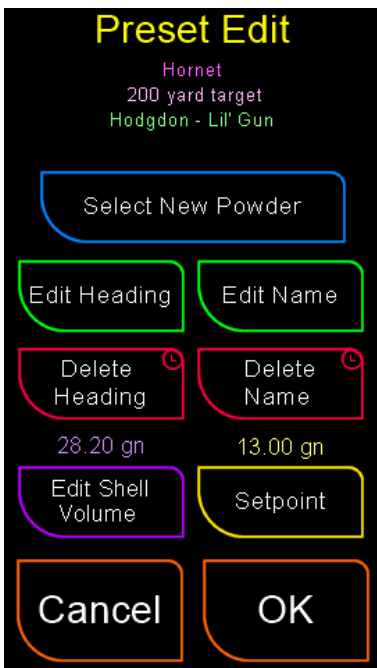

**Warning:** If you delete a heading that still has Names under it, all those names will be deleted along with the heading.

## Modes

The SuperTrickler has three modes of operation.



**Normal**: this is the standard operational mode.

**Ladder**: this mode will generate a ladder of charges.

**Top Up**: used if the SuperTrickler is used to only complete a charge rather than dispense the entire charge.

**Weight Logging**: used to log weight of objects. Examples are to weigh and sort brass, bullets, primers etc.

Both Ladder and Top Up require additional information and settings for that mode. When either of these two modes are in operation, the Dispensing Screen will display a mode setting (see the Dispensing Screen above item 6.). In the case of Top Up mode, the indication will flash, highlighting the caution needed in this mode.

## Ladder Mode Setup

Ladder Mode is designed for ladder testing, which is making a range of loads to find the specific charge that is most accurate. The system is designed to be flexible, when entering any value into the green fields the SuperTrickler will calculate the other green field values, based upon the number of steps entered in the blue field. All green fields are rounded down to a resolution equivalent to the scale resolution (0.02 gr).

There are five parameters required for a ladder test.

The screenshot shows the 'Ladder Test' configuration screen. It features several input fields and controls:

- Steps:** 10 (blue border)
- Step Increase:** 0.56 (green border)
- Rounds per Step:** 5 (blue border)
- Low Charge:** 45.00 (green border)
- High Charge:** 50.00 (green border)
- Step Options:** 'Up' is selected, 'Normal' is unselected.
- Buttons:** 'Cancel' and 'Begin'.

**Steps** (top blue): The Number of ladder Steps (changes in charge set point).

**Rounds per Step** (mid blue): how many charges are dropped at the steps weight.

**Step Increase** (top green): The weight increase per step.

**Low Charge** (mid green): The lowest weight in the ladder.

**High Charge** (bottom green): The highest weight in the ladder.

After entering the number of steps, it is common to first enter the Step Increase and then the End Charge value, being the theoretical maximum charge weight; letting the system work backwards and calculate out the Start Charge value, however values can be entered in any order and the system will continually calculate out the remaining fields.

**Step Options:** The first is **Up/Down**, this dictates the if the charge will start at the lowest value and work up or start and the highest value and work down.

The second option is **Normal/Pause**: Pause will pause at the completion of each step (weight change). You will need to press Start to continue on to the next step.

Once you are satisfied with the ladder parameters, pressing “Begin” will take you directly to the Dispensing Screen, ready to begin.

**Warning:** Check that **all** the green fields are within the specifications you require before beginning the ladder operation.

## Ladder Mode Operation

When in ladder mode the charge screen will display two pink buttons, Repeat Last Charge and Skip.

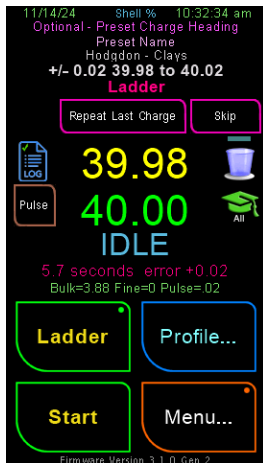

The Repeat button prevents the ladder from moving to the next charge/stage, thus repeating the last charge. This can be used if for some reason the operator is unhappy with the charge or the charge cannot be used for some other reason, e.g. spills.

The Skip button is used to skip the next pending charge.

To save time, some users prefer to see if the overthrow can be utilized elsewhere in the laddering range and if so they then place the charge in that position. Later when the SuperTrickler laddering stage gets to a spot that has already been utilized the skip can be pressed to jump over that point.

## Top Up Mode

The top up mode was requested by some users, where they only want the SuperTrickler to make the final accurate charge.

**WARNING:** You cannot use multiple powder cups in this mode.



There is one parameter and one measurement required.

The charge target set point must be entered. This is the value to which the SuperTrickler will top up the charge.

The other is measurement of the empty powder cup weight.

Once the cup weight has been measured, the “Begin” button will be enabled, allowing you to then press “Begin”, then taking you directly to the Dispensing Screen to start the process.

**NOTE:** Under normal operation the scale is zeroed at the start of each charge to maintain the best possible accuracy. However, in this mode this is not possible. It is recommended to periodically reselect the top up mode and remeasure the cup weight.

## Weight Logging Mode

Weight logging is designed for recording a series of weights for objects such as brass cases or bullets. The screen shows weights, counts and allows for setting some groups and other values. These are recorded to a file on the SD card named weight.csv in the \log folder.

Typical for reloaders, 'batches', Groups, or 'Boxes' of cases are weighed. You might have 3 boxes of 50 rounds of brass to weigh. You can use the Up/Down arrows to set the "Group" setting number. This Group X gets recorded in the file on each line. The larger counter is the total number of objects weighed, while the smaller one under the group name is the count in THIS group. It will reset if you press the Up/Down arrow to change the group name. (So you can record case #X in Group #Y, and also keep a total count.).

You have two different modes, direct weight, or including an offset/reference weight to deduct. If the Use Cup button is off, the actual weight of the object is shown/recorded. IF Use Cup is ON, then the system will ask you to put the reference 'cup' on, and it will subtract that reference from each weight recorded. This is used to weigh small objects, maybe bullets, or primers that would otherwise be hard to put on/off the platen of the Scales.

**Make sure to press the Close button before removing the SD card.**



1) Current Scales reading

2) Recorded weight

3) Total Item Count

Arrows are to increase/decrease the Group number. Display shows Group Number and Count within that group. The group count resets when you change the group number.

Use the Ignore Read button to throw away the current value and not record in the file.

Enable Logging toggles the logging on and off

Press and Hold the Delete button to delete the log file

Use Cup: Press this button to create an 'offset' for the cup. It will guide you through the procedure to use the cup.

Zero Scale: Allows you to zero the scale

Close: End this session and record the final value in the log file.

**IMPORTANT NOTE: YOU MUST use the Close button BEFORE removing the MicroSD card to record and close the log file! Not doing this could result in losing values in the log.**

## Empty Hopper

Use this button to temporarily 'lock' the screen from accidental button pushes and dispensing while emptying the SuperTrickler. The screen below will show, Press and hold for 3 seconds to return to normal operation. This is used to prevent accidentally pressing any buttons while emptying the hopper, and causing powder spillage.

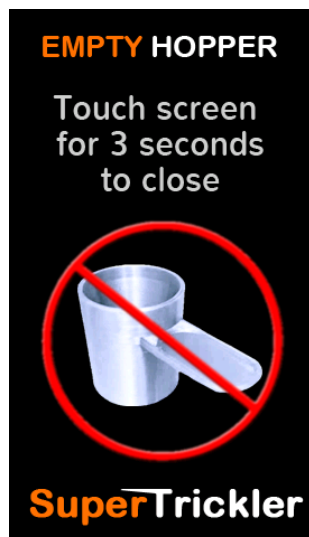

User Notes...



## Operational

The operational part of the system is the Tools & Settings menu, where options and functions that may be required in the general operation of the SuperTrickler can be found.

### **Tools & Settings Menu** *Menu, Submenus*

The Tools & Settings menu is the starting point of the many mainstream operational functionalities.

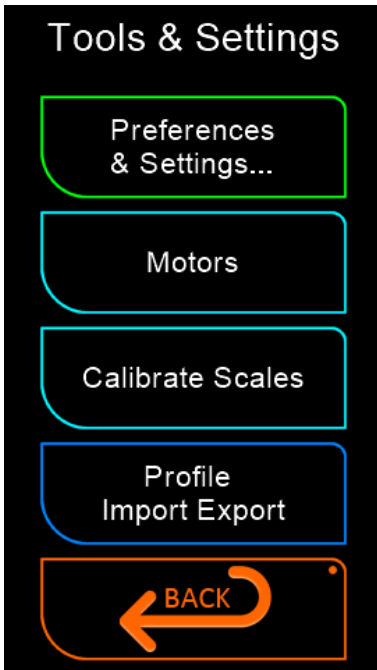

**Preferences & Settings...** will take you to the many mainstream Preferences and Settings.

**Motors:** allows you to prime, purge, test, flow test and change the bulk trickler tube.

**Calibrate Scales:** use the SuperTrickler interface to calibrate the scale.

**Profile Import Export:** Allows for import/export of the current Powder Profile

### **Options & More** *Menu, Submenu's, Preferences & Settings*

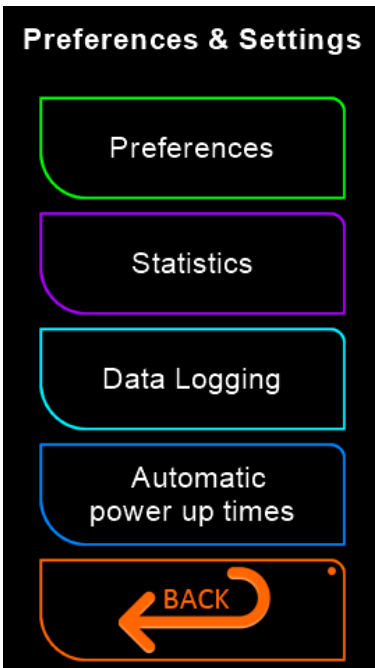

**Preferences:** will take you to the many options, such as: display brightness, start-up options, charge screen, times, audio options, work light options and external control.

**Statistics:** will take you to a screen that displays system metrics etc. Important information included is the 'Current Powder Used'. This is reset whenever the powder is changed.

**Data Logging:** Go to the settings for [Data logging](#).

**Automatic power up times:** is an easy system to quickly setup automatic power up times, allowing the SuperTrickler to be warmed up and ready when you are.

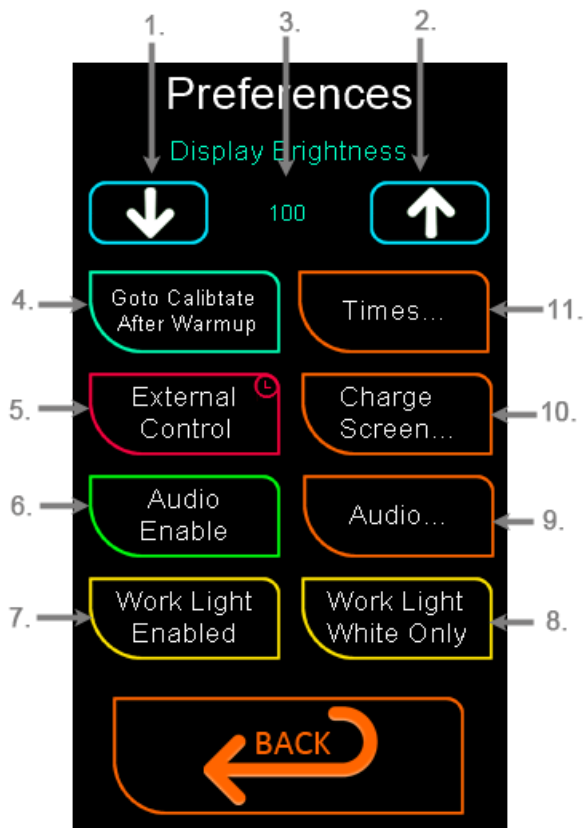

1. Display brightness – dimmer.
2. Display brightness – brighter.
3. Display brightness value.
4. Enable/Disables SuperTrickler to automatically go to the calibration screen once the system is warmed up and ready. We highly recommend regular calibration, and this system makes it easy.
5. Enable/Disable external control (Flashes when enabled, needs to be held down to change)
6. Enable/Disable audio sounds.
7. Enable/Disable the work light.
8. Disables the use of colors with the work light.
9. Audio setup sub-menu, this allows you to change the tones of many of the various beeps. For anyone with impaired hearing, these settings can allow you to control pitch of the alerts and tones.
10. Charge Screen Preferences.
11. This submenu enables you to setup warm up times, power down and sleep times.

**Times Option**

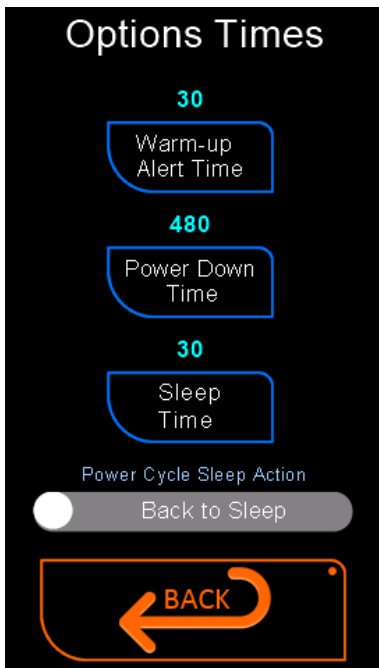

**Warm-up Alert Time:** (in minutes) when powered up, the system will wait until this time, then turn on an audible alarm and display a ready alert screen. A value of 0 will disable this function.

**Power Down Time:** (in minutes) after this time, when no activity is detected, or the system is sleeping, the system will power down. It will turn off the power to the scale and puts the SuperTrickler into hibernation. To reactivate, touch the screen. A value of 0 will disable this function.

**Sleep Time:** (in minutes) after this time, when no activity is detected, the system will go into sleep, turning off the scales display only and puts the SuperTrickler into hibernation. To reactivate, touch the screen. A value of 0 will disable this function.

**Power Cycle Sleep Action:** Back to Sleep/Stay Awake, this option dictates what happens if the SuperTrickler is sleeping or powered down (deep sleep) and the main power is cycled. The Setting will tell the SuperTrickler to either go back to sleep or power down as it was, alternatively it will stay awake as though it had just been woken up.

alternatively it will stay awake as though it had just been woken up.

## Charge Screen Preferences

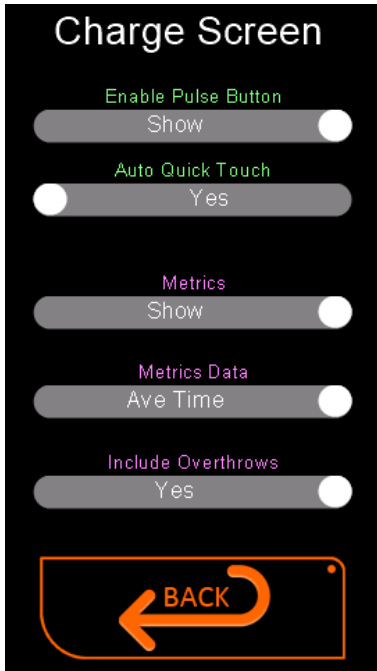

**Enable Pulse Button:** Hide/Show – use this to enable the manual pulse button on the charge screen.

**Auto Quick Touch:** Yes/No – When ON, will allow a quick touch of the manual Pulse button, to automatically run the pulse cycle until the scales detect a change in weight. Holding the button longer will initiate a single pulse.  
If set to NO, then touching or holding the button will initiate a single pulse.

**Metrics:** Hide/Show - Control the statistical data that is shown on the charge screen.

**Metrics Data:** Success Count/Ave Time – either show the success information or the average time information.

**Include Overthrows:** No/Yes – controls if an overthrows time is included in the average time.

## Audio Option

The main options page has an option to disable the audio beeps. This is for convenience in the event that you do not desire the beeps. For example: if reloading in your kitchen or late at night when the beeps can disturb others.

Many people have difficulty hearing certain ranges of frequency (pitch). These options allow you to change the pitch or turn off some of the key alerts.



**Touch:** this is the sound whenever you touch the screen.

**Warm-up:** this is the alert sound you hear when the warm-up time has expired.

**Success:** is the “charge successful” alert.

**Discard:** is the “charge failed” discard alert.

## Statistics

Displays various statistics about your SuperTrickler such as Charges, Run-times, Powder Usage & Loaded Count.



In general, most the information on the screen is self-explanatory, however the Current Powder Used and Profile Loaded Count are less obvious.

The **Current Powder Used**, shows the amount of powder used since the powder type has been changed from either directly choosing a different powder or selecting a profile with a different powder.

The **Profile Loaded Count** will show the number of successful charges made from this profile. At any time you may edit this (**Edit Loaded**) value to any value desired. This can be helpful in managing and counting load batches.

## Data Logging

The data logging ability of the SuperTrickler is an important feature. There are two main log files stored on the micro-SD card. The log file size is limited to 3.9 gigabytes (4294967295 bytes), an enormous amount of data. For more detailed information see the "[Charge Log Files](#)" later in this document.

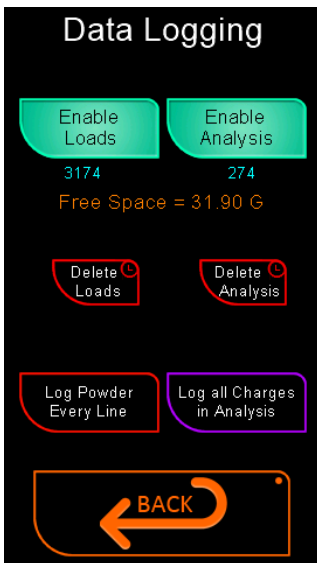

There are two separate log files; one for successful charges (loads.csv) and the other for analysis or failed charges (analysis.csv). The analysis file logs failed loads and contains all the same fields as the successful loads, with additional information that can be used by our support team to analyse the reasons why the failed load occurred. When you first open the logging options page an hourglass will appear while the system reads the file sizes and free space.

Once open, you can turn on or off either of the log files; however, it is highly recommended to always leave the failed log file running. The button will be highlighted when ON.

Holding the **Delete** buttons will delete the existing file and recreate a new file.

**Log Powder Every Line:** toggles between logging modes, that will place the powder and or preset in every line. See the *Charge Log File* section for details.

**Log all Charges in Analysis:** toggles between logging modes, when this is on, every charge good or bad will be logged in the Analysis file. See the *Charge Log File* section for details

## Automatic power up times Menu, Submenus, Tools & Settings, Preferences & Settings

Automatic power up times enables you to have a preset time for a given day when you would like your SuperTrickler to be warmed up and ready. The SuperTrickler will take into consideration the warm-up time if set in the options “options ▶ times ▶ Warm-up Alert Time”

**NOTE:** The SuperTrickler will wake from a sleep or power down state should it be in that mode when the wake-up call is initiated.

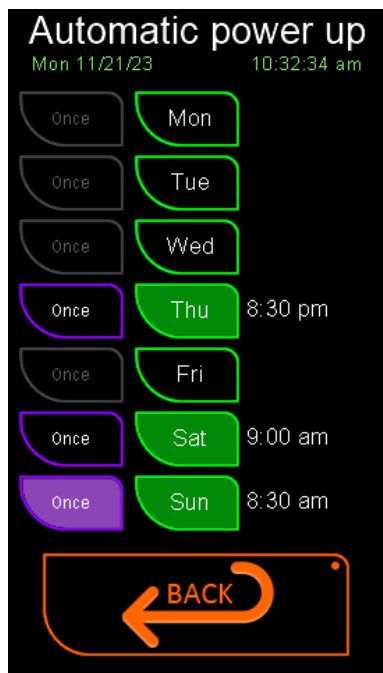

To set a time:

Press the day button, then on the keypad enter the time the SuperTrickler is to be ready, then press OK.

The time will be displayed on the screen, indicating its activity. This will repeat on this day until you disable it. Enabled days will be green.

To disable time:

Simply press the day button that you require to be disabled.

To re-enable a time:

Press the day button and the previous time used will be automatically added to the keypad. You can either change this time or simply press OK to accept the previous time.

Pressing the ‘Once’ button will allow the set wake up to happen just once (not repeat weekly).

This screen is for common motor function and testing to establish motor speeds and powder flows.

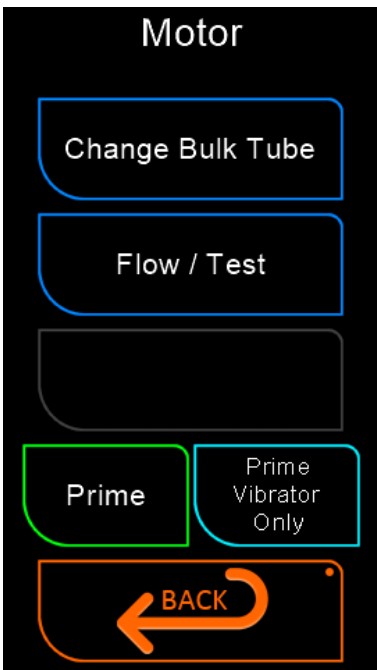

**Change Bulk Tube:** takes you to a menu that assists in the removal and installation of the bulk trickler tube.

**Flow / Test:** will take you to the motor’s flow and testing screen.

**Prime:** Primes both tubes for 6 seconds

**Prime Vibrator Only:** will prime only the vibrator tube for 45 seconds.

You can stop the priming process at any time by pressing the priming button again.

Each priming button will also issue a warning to check a cup is in place before starting the prime, you can shortcut the delay by touching the red warning panel.

### Change Bulk Tube

This functionality is designed to assist you in removing and installing the bulk trickler tube.

**Warning:** Do not remove the bulk trickler tube with powder in the hopper. Doing so will allow powder into the body of the unit and will require cleaning from an authorised service center, at your cost.

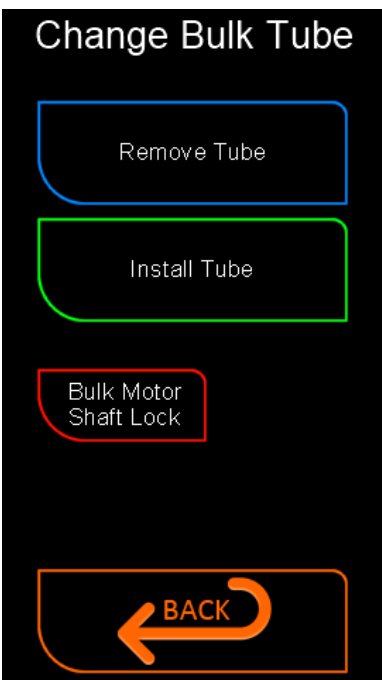

**Remove Tube:** will run the motor in reverse for around 10 seconds. By holding the end of the bulk tube during this time, the tube should easily unscrew itself.

**Install Tube:** will run the motor in forward for around 10 seconds. Holding the end of the bulk tube, place it against the threaded motor shaft and allow it to screw on, until the motor stalls, then release the tube. Be careful to not cross thread the tube.

**Bulk Motor Shaft Lock:** will lock the bulk motor’s shaft for 10 seconds, to assist in the removal of the bulk trickler tube, in the event the above methods are unsuccessful.

**Note:** If you exit this screen without re-installing the bulk tube, the red working like will flash continuously on all screens.

## Motor Testing

This functionality is designed to test motor speeds and flows for best performance with a given powder and when manual profile alterations are required.

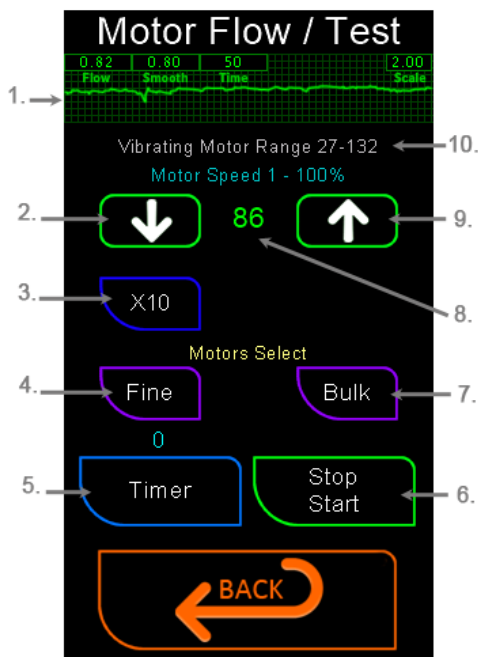

1. See the section on the [Powder Flow Graph](#).
2. Speed DOWN 1 or 10 units (hold to repeat)
3. x 1 or x 10 units per arrow press
4. Enable fine motor
5. Sets the run time for test
6. Start/Stop the selected motors
7. Enable bulk motor
8. Current motor speed %
9. Speed UP 1 or 10 units (hold to repeat)
10. Current vibrator motor speed range settings

## Calibrate Scales Menu, Submenus, Tools & Settings

The SuperTrickler scale calibration is just an easy interface into the standard calibration system. The process takes you through the calibration procedure in steps

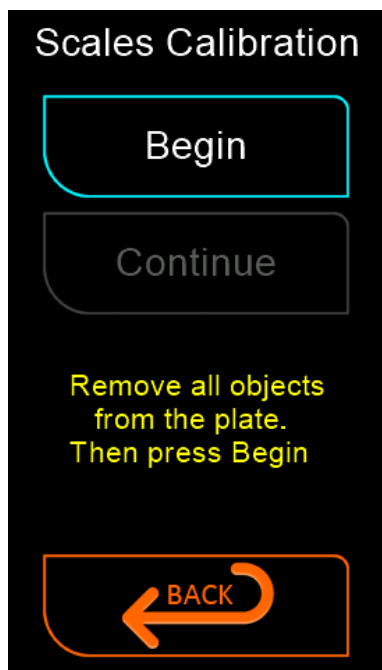

**NOTE:** You will need a precision standard 50 or 100 gram weight if you have an FX series scale. It is highly recommended that you never touch your calibration with your bare hands, as your skin oils can change and damage the weight.





Once you have entered the calibration page, it is simply a matter of following the instructions as they appear.

### Scale Calibration Weight

The A&D FX-120i scale can be calibrated with either a 50 gram or 100 gram precision standard weight. The default is for a 100 gram weight, and that is what is recommended. Should you require using a 50 gram weight, see below.

To set the scale for a 50 gram precision standard weight.

With the scale running and ON.

| Steps | Button  | Instruction                    | Display | Information             |
|-------|---|--------------------------------|---------|-------------------------|
| 1     |  | Press <b>Cal</b> for 2 seconds | cal 0   | Calibration             |
| 2     |  | Press <b>SAMPLE</b>            | 100.000 | 100 gram weight         |
| 3     |  | Press <b>Mode</b>              | 50.000  | 50 gram weight          |
| 4     |  | Press <b>PRINT</b>             | cal 0   | Save change             |
| 5     |  | Press <b>Cal</b>               |         | Exit calibration change |

Note: Repeat the steps to change back to 100 grams calibration if required at any time.



This menu is used to import and export Powder profiles for support or sharing. The files are in the \share folder of the SD card. This feature is also available from the Powder and Preset screens as well.

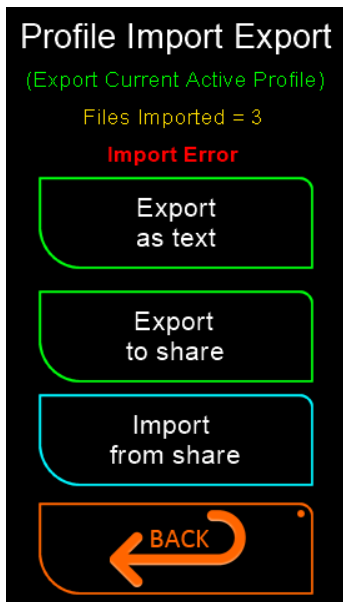

**Export as text:** Used to export the current Powder profile in a readable text file on the SD card in the \share folder of the SD card. The file will have a name similar to the powder selected and have the extension .txt

**NOTE:** A profile pro-forma file needs to be present for this functionality. The file is in the system folder and called \sys\profile.pf if this is missing it can be downloaded from the web site.

**Export to share:** Exports current Powder profile in a binary shareable file to send to other users in the \share folder of the SD card. The file will have a name similar to the powder selected and have the extension .pie

**Import from share:** Imports a shared Powder profile that was placed in the \share folder of the SD card. You will be prompted to import each file that is found. Entries in Blue are new entries, ones in Red will overwrite an existing profile with the same name.

You may export multiple powder profiles in one session. Each time you hit an export button; you will get a file exported that contains the current powder profile.

**It is important to note that when using the Import function, any profiles with the SAME NAME (RED text) will be overwritten.**

You will be asked for confirmation during import for each profile being imported with the following screen:

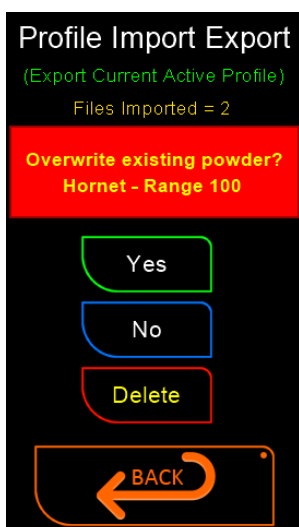

**Yes:** Import the named Profile (proceed, and auto delete the file when done.)

**No:** Ignore the named profile for now, will ask again next time.

**Delete:** do NOT import and DELETE the file from the SD card.

To use the Import/Export feature, follow the steps below:

**Export:**

- 1) Export the Preset[s] or Profile[s] you want to the SD card. You can only export the currently active Profile, so if you want to export multiple ones, just use the 'Select Preset' to active another profile.
- 2) After exporting, remove the SD card and place in your computer.
- 3) Open the SD card and look in the folder names 'share'
- 4) Find the appropriate .pie files you exported (names are like the profile/powder names they came from)
- 5) Either Copy/Move the .pie files from the SD card to your computer (if you copy, please remove the files from the SD card) or simply share them directly from the SD card (Email, FB...)
- 6) Eject the SD card from your computer and reinsert into the SuperTrickler.

**Import:**

1. Remove the SD card from the SuperTrickler.
2. Insert the SD card into your computer.
3. Copy any .pie files you want to install on the SuperTrickler into the share folder on the SD card.
4. Eject the SD card properly from your computer.
5. Insert the SD card back into the SuperTrickler.
6. It should bring up the Import/Export screen and prompt you to import/ignore/delete each file it finds. It will create new or overwrite the existing Powder and/or Preset. (as indicated by blue or red text as stated above.)

User Notes...

## System

The system section of the SuperTrickler contains all the non-mainstream functionality, deep settings, configuration, factory restores, upgrade and testing facilities.

### System Menu Menu, Submenus

The system menu is the gateway to the many system settings, configuration and diagnostics.



**Peripherals...:** are the sub devices attached to the SuperTrickler. These are the micro-SD card device, the scale, and the powder cup laser sensor.

**Date & Time...:** to set the current date and time. This functionality includes the date, time formats and daylight savings switch.

**Expansion Port...:** to configure expansion port options and functionality.

**Setup...:** is the system setup menu for; configurations, firmware updates and factory restore functionality.

### Peripherals Menu, Submenus, System

The system peripherals are devices integral to the standard operation of the SuperTrickler.

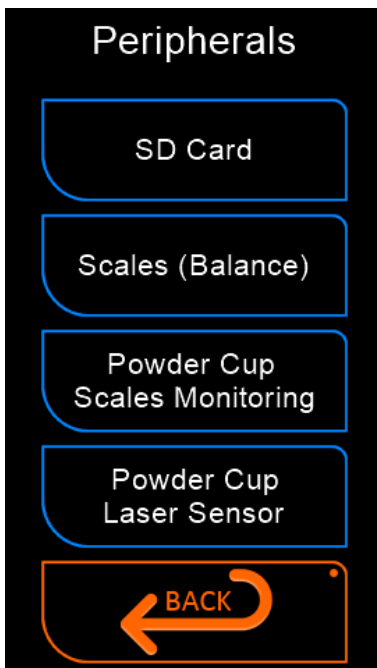

**SD card:** will give information about the installed micro-SD card, formatting and recreating the data structure can also be performed from this page.

**Scales (Balance):** allows you to diagnose the data stream from the scale and to configure the operation settings. Scale calibration is also available from this screen.

**Powder Cup Scales Monitoring:** is the setup that controls the powder cup monitoring using the scale.

**Powder Cup Laser Sensor:** is an optional laser, that will monitor the cup in addition to the scale weight data. This screen will enable the operator to read the laser operation in real time and to set its operational parameters. This option may not be available if the laser is disabled in the system deep settings. **(Note: This feature is experimental at this time, use with caution.)**

## SD Card *Menu, Submenus, System, Peripherals*

The SD card contains log files and the database for powder profiles and custom pre-set profiles, along with several other system files.

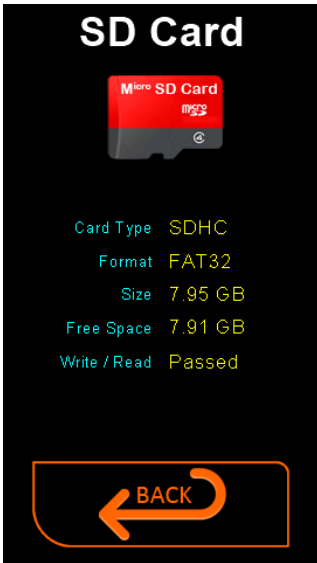

When you first open this page the SD card details will be displayed, however the free space and Write / Read test will take a few seconds to display.

Note: The Free Space is displayed as Gigabytes (GB) when its above 1 GB and below this the value will be displayed in Kilobytes (KB).

### *Formatting the SD card.*

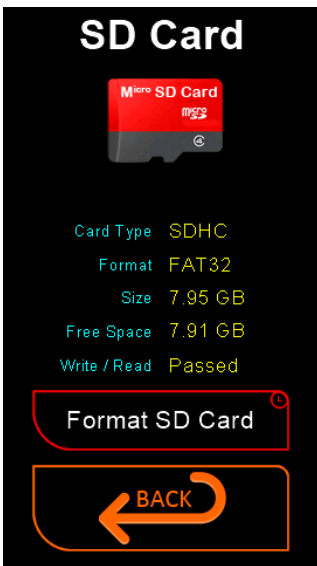

It is critical that you use the SuperTrickler formatting function and not use a card formatted by a personal computer. Often personal computers will not use a fully  **SD Association** compliant format. The card might work in general but may not support the firmware update functionality that is card-format critical.

Warning: all data, log information and system support information will be lost when formatting. Should you wish to keep all your data and just upgrade or replace the card you can simply copy all the data on the old SD card into a personal computer, then format the new card using the SuperTrickler. After the formatting has completed, simply copy the data back onto the newly formatted card. The format function will automatically add some system files and folders and you can overwrite these with the old data.

### *How to invoke the format function.*

The format function is not immediately available to the operator; this is to prevent accidental formatting.

Step 1. Press and hold the Micro-SD card picture for 2 seconds (after the Write/Read test has completed) *this will enable the Format SD Card button.*

Step 2. Press and hold the 'Format SD Card' button for 2 seconds and the format will begin.

An hourglass ⌚ will be displayed during formatting and the screen will be refreshed when finished.

**Warning: Removing the card or the loss of power during the formatting process may destroy the card.**

## Scales (Balance) Menu, Submenus, System, Peripherals

It is common to use the term scale or scales in place of balance. They are technically different however for the sake of clarity 'scale' has a more intuitive annotation.

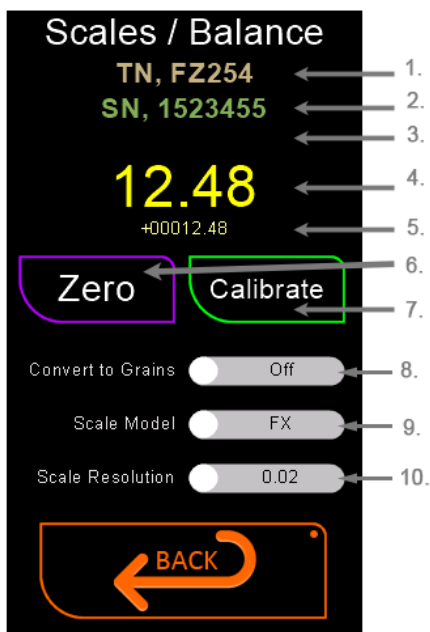

1. A&D model number.
2. A&D serial number.
3. Shows if the display has been converted from Grams to Grains (see button 8 just below).
4. The scale value.
5. The data stream sent from the scale to the SuperTrickler. This can be critical information when trying to diagnose a communications error.
6. This will re-zero the scale.
7. This button takes you to the Scales Calibration page.
8. As some A&D models only work in Metric Grams, turning this on will convert the weight from the scale into Grains. If the data is detected as being in the grams format this option will be automatically turned on.

9. Toggle FZ Calibration mode on/off (should be auto selected if you have an FZ series scale.) If the system detects the FZ type then this option will be automatically turned on.

10. This button turns on the high-resolution mode and allows selection of 0.01 rather than the standard 0.02 grains. Warning: Do not set this to 0.01 unless your scale supports high resolution.

Note: The SuperTrickler uses an advanced Scales Data Parsing (reading). This system is very fast and detects the scale data type (grains or grams) on the fly and should the scale inadvertently be switched to grams the new parser will detect the change and convert the grams data back to grains on the fly without interruption.

## Powder Cup Scales Monitoring Menu, Submenus, System, Peripherals

The Powder Cup Setup uses the scale to read the weight to determine the status of the powder cup.



**Off weight:** this will be a negative value well below zero where the cup would be considered as removed or “Not on the scale”

**On weight range min:** this will be a negative value just below zero where an empty cup would be considered close enough to “Empty on the scales”.

**On weight range max:** this will be a positive value just above zero where an empty cup would be considered close enough to “Empty on the scales”.

**EDC weight range max:** External Control Device weight max, this is identical to the On weight range max, however this value is used rather than the On Weight max when the external device is in use. This value should be set high enough to allow a small amount of scale drift. When the cup is returned by the ECD, the weight is measured and in the event the cup weight is larger than this value, a Dangerous Error signal will be sent to the ECD and the last filled cartridge will be flagged as faulty. The ECD will take the cup and discard the content, then return the cup to continue the charge and

filling operation.

**Ready Settling:** this is a time in milliseconds that allows the scale to stabilise after an empty cup has been put back on the scale. If this time is too short, you may be zeroing the scale before they are stable, generating an error and possible incorrect charge.

## Powder Cup Laser Sensor Menu, Submenus, System, Peripherals

The SuperTrickler is equipped with a laser sensor to detect the cup. This functionality is optional (enable/disable) and can help prevent starting a charge without the powder cup in position. This system is used, in conjunction with the powder cup monitoring system, to ascertain the status of the powder cup. Other systems on the market generally just use the weight on the scale to determine this and prevent starts without the cup in position. However, with this comes a serious compromise, in that the scale is not re-zeroed before each charge and only allows the use of one powder cup or cups that are precisely the same weight. The laser helps to overcome this issue and several cups can be used without any consideration to weight. It is recommended the same cup design be used to allow the laser to detect the same dynamics.

The program will display an oscilloscope-type wave form of the laser distance as a visual guide, along with the cup status picture as detected by the laser and the laser distance reading. There are 3 settings that need to be set to configure the laser, if enabled:

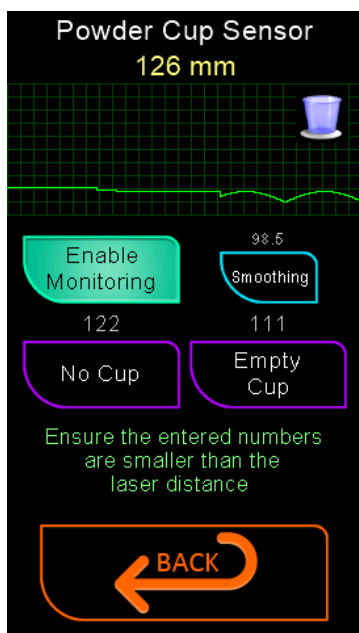

**Enable Monitoring:** Enables the laser system. This will add an additional safeguard against an accidental charge without the cup in the correct position. There is no compromise on accuracy doing this as the SuperTrickler will still perform a zero at the beginning of each charge.

**No Cup:** is the distance when no powder cup is present.

**Empty Cup:** is the distance when the powder cup is present and empty.

**Full Cup:** is the distance when the powder cup is present and full of material.

**Smoothing:** Adjust laser filter sampling to smooth the curve/readings. The laser beam is subject to noise and stray reflections etc resulting in an unstable reading. The smoothing control is used to filter out the noise to obtain a usefull distance measurment. Too little smoothing and the distance measurment will be unstable and unreliable. Too much smoothing and the distance measurement will be slow to react and may interfeare with the smooth flow of the powder cup detection and charging operations. A value of around 98.0 is about right however if it does required changing, try very small adjustments a value of 1.0 is a large change..

To set the No Cup and Empty Cup, place the cup either on or off the scale plate and allow a small amount of settling time then set the value a few mm lower than the reading (this keypad will default to this value).

**Note: The entire laser system can be disabled in the Deep System Setup menu.**



## Date & Time Menu, Submenus, System

The SuperTrickler has a built-in Real Time Clock, tracking the time and date. The format of the date can be selected to suit your country's standards and preference for 12- or 24-hour time format.

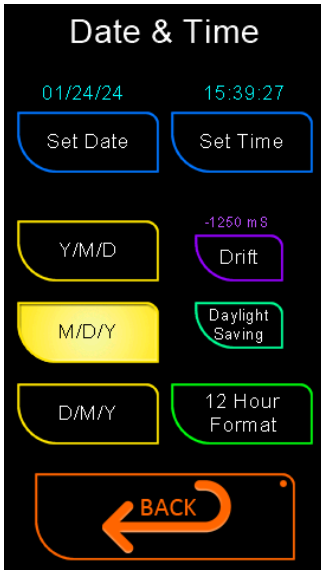

When selecting, the keypad will automatically format the time or date for you, so it is important to first select the date and time format preferred and daylight saving (on or off) before setting the time and date.

Daylight Saving does not automatically put the system into daylight savings tracking, rather it is a convenient way to subtract an hour (DLS on) or add an hour (DLS off) to the current time.

**Note:** Real Time Clocks are subject to drift. To keep your log file record times accurate, it is recommended to check the time regularly with a known accurate time source and adjust the time accordingly. If you find that the clock drifts, you can use the 'Drift' button to apply a correction.

The value shown is the 'drift' observed over 1 day (24hours). Here is an example of how to use it. Say you set your clock at 21:21:21 on 11/23, and at 22:22:22 on 11/25 you see the clock is behind by 20s from a trusted clock. Calculate the number of days and divide 20s by that. (The example is  $2d+1h+1m+1s$ ,  $2*24*60*60+1*60*60+1*60+1$  (convert everything to seconds) that's 176,461s. Now to days is  $(84,600s/day)$   $176,461/84,600=2.0858days$ . So, then  $20s/2.0858d = 9.588s/d$ . To correct for the drift, set the drift to +9588. That will add 9.588s per day to the clock.

Of course, you could also just keep resetting the correct time on the clock via the keypad when it drifts more than you like!

## Expansion Port Menu, Submenus, System



**NOTE:** Menu items on this screen will only appear when the feature has been activated.

## Setup Menu Menu, Submenus, System

The System Setup menu is the operational core of the system's heart. From here you can configure the default powder profile, adjust the vibrator motor speed range, access the core system functionality, and access the factory restore menu.

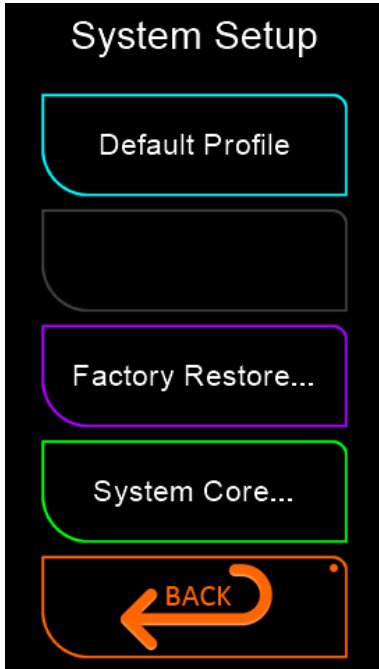

**Default Profile:** is the profile used when no other previous profile can be found for a given powder. It is also the profile used when initiating a “Restore default” to an existing profile. See Powder Profile for more details.

**Factory Restore:** takes you to a menu that allows you to select a section of the system that you may want to restore to factory defaults.

**System Core:** is a menu of the non-specific core system functionalities.

## Factory Restore Menu, Submenus, System, Setup

There are multiple ways to restore settings. These include a full factory reset, or the ability to just restore certain sections of the SuperTrickler.

Each restore button must be held in for at least two (2) seconds before the restore will take place to avoid unintentional execution.

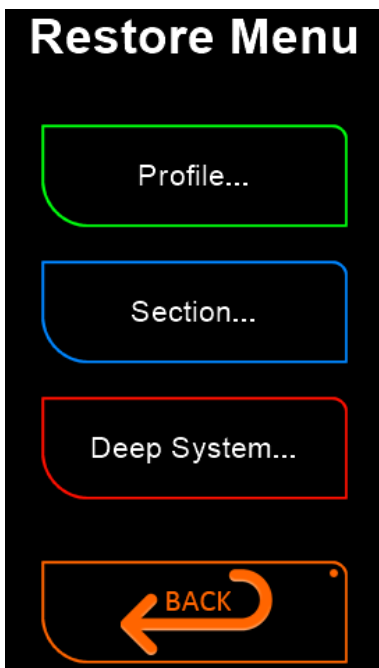

**Profile:** Menu for resetting the default profile or to delete all the existing profiles.

**Section:** Menu for general section restore; Powder Cup, Audio, Options & Scale.

**Deep System:** Menu for deep settings; Deep System Settings, reset Memory and reset all settings to the factory defaults and Complete Factory Restore -this is the same as pressing every restore button including deleting all profiles from the SD card. **USE WITH CAUTION!**

## System Core Menu, Submenus, System, Setup

The system core menu is the deepest area of the system's heart, allowing you to access the firmware updates and initiate a system basic self-test.

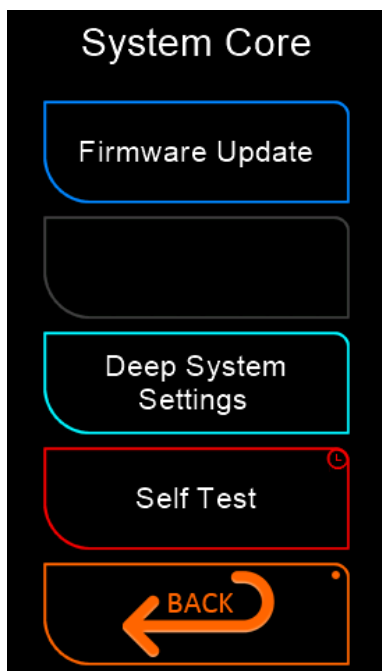

**Firmware Update:** when the system detects a new firmware update on the SD card, it will automatically take you to this page. You may wish to simply exit the page and do the update at a later time.

**NOTE:** In some circumstances, an update may be initiated without intervention (as soon as it's detected).

**Deep System Settings:** Used to change Deep System Settings (See below)

**Self Test:** will run a self-test program (mostly for use by service technicians).

## Firmware Update Menu, Submenus, System, Setup, System Core

Training Video Available: [https://youtu.be/hmzx0pM\\_AYY](https://youtu.be/hmzx0pM_AYY)

# **DO NOT FORMAT OR DELETE THE CONTENTS OF YOUR SD CARD AS ANY PART OF THE UPGRADE PROCESS.**

The firmware update system is a powerful system, where a single update file can be downloaded from the web, copied onto the Micro SD card, and installed on the system. Unlike many other systems you may have encountered, the SuperTrickler update system takes great care to ensure each update file is 100% corruption free. These files are both tamper and corruption checked for 21 facets before beginning an update. The system can be reversed to previous versions if required. Upon completion of the update, the updated file will be removed from the Micro SD card. Then naming convention for the file is described in [Appendix A](#).

### NOTE:

1. It is highly recommended that the what's new document be studied prior to running an update, as in some circumstances the update will initiate a factory reset of one or more areas of the system.
2. When the system detects a new firmware update on the SD card, it will automatically take you to this page. You may wish to simply to exit the page and do the update at a later time.

3. In some circumstances an update may be initiated without intervention (as soon as it's detected).

### **Important: Roll Back Strategy**

With each version upgrade, as in any complex software system, the results of the upgrade may not yield desirable or beneficial results. You may wish to 'roll back' or return to the previous version where you were having more desirable results. In general, rolling back the software is not an issue; however each version tends to modify your profiles a bit and this can make the roll back annoying, losing your finely tuned profiles. Before upgrading, please follow the directions below to save the current version of your profiles in case you decide to roll back.

#### **TO SAVE YOUR CURRENT VERSION PROFILES BEFORE UPGRADING:**

When you take your Micro SD card out to load the upgrade file on it (as described in the Install section below), make a copy of the BIN folder, either on your computer or on the SD card. You can name it anything OTHER than BIN (e.g., BIN220 or BIN310). **DO NOT REMOVE THE ORIGINAL BIN FOLDER.**

Complete your upgrade. If you find you want to roll back, simply rename the existing BIN folder to BIN311 or delete it. Then, rename your BIN220/BIN310 back to BIN, perform the rollback update, and you will be back to your previous state before the upgrade.

### **Install**

1. With the SuperTrickler **powered on** and from the main sub menu, remove the Micro SD card (tweezers are a great help).
2. Copy the .stf file on the root (default folder) directory of the Micro SD card.
3. Reinsert the card back into the SuperTrickler.
4. The system should automatically take you to the Upgrade screen. (System – Setup - System Core – Firmware Update)
5. Press & Hold the Start button for several seconds until the process starts.

**Warning:** during an update, the green work light will flash, indicating firmware progress. Green was chosen, as it has the least potential to trigger epilepsy, however, if you are prone to epilepsy, it is recommended to look away during the update. Adequate time will be given with a warning before this process begins. During other parts of the update, the system may flash a purple light at a rate outside the epilepsy sensitivity range.

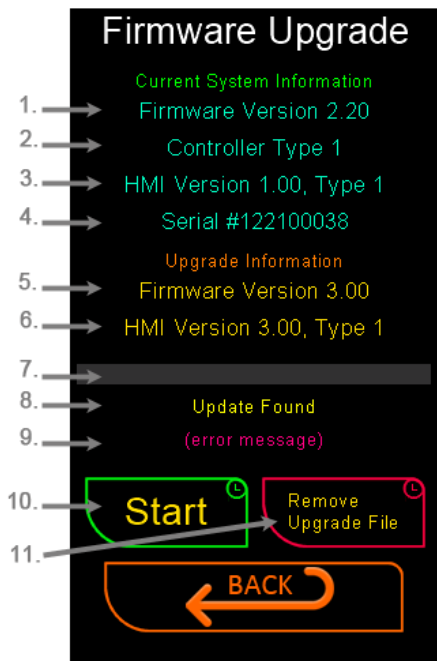

1. Current controller firmware version.
2. Hardware (controller board) version.
3. Current HMI (Human Machine Interface) touchscreen firmware version and hardware type.
4. Machine serial number.
5. The controller update firmware version.
6. The HMI update firmware version.
7. File unpacking and checking progress bar.
8. Status and process information messages.
9. Error message.
10. Start button; this button must be held in for over a second before the update starts to avoid unintentional execution.
11. Remove Upgrade File; this button must be held in for over a second before activating. Use it if, after a successful update, the system still thinks the update file is there.

To obtain firmware updates please go to: <https://supertrickler.com.au/firmware>

### Update Error codes

| Code                      | Reason  | Fix  |
|---------------------------|---|--|
| E0: Undefined Error       | This error is caused by undefined reasons and should not occur.               |  |
| E1: cannot open file      | The .STF file cannot be opened.   | Check SD disk format and reinstall the .STF file                                   |
| E2: unknown format        | The .STF file format is an unknown type.                                      | Download & reinstall the .STF file   |
| E3: descriptor size       | The part of the file that has the update information is not the correct size. | This may be caused by upgrading from a very early version to a much later version. |
| E4: descriptor CRC        | The descriptor data is corrupt  | Download & reinstall the .STF file   |
| E5: retired format        | The update file is no longer supported  | Download the latest or matching .STF file  |
| E6: not valid file        | The file marker STPK is not present   | Download & reinstall the .STF file   |
| E7: wrong product         | The file is not suitable for your SuperTrickler product code                  | This is rare and is possibly caused by using a special .STF file                   |
| E8: wrong serial          | The .STF is not compatible with registered serial number                      |  |
| E9: CB firmware version   | The controller board firmware is not compatible with HMI update.              | Download the latest or matching .STF file  |
| E10: HMI firmware version | The HMI version is not compatible with the controller firmware version.       | Download the latest or matching .STF file  |

|   |   |  |
|---|---|--|
| E11: CB hardware version  | The controller board hardware (board type) is not suitable for this controller firmware   |  |
| E12: HMI hardware type  | The HMI hardware (Display type) is not suitable for the HMI firmware.   |  |
| E13: creating CB file   | There was a problem creating the file that the controller firmware is unpacked into.  | Check SD disk format or disk space                                   |
| E14: CB write size  | The unpacked controller firmware file did not unpack to the correct size.   | Check SD disk format or disk space                                   |
| E15: CB read CRC  | The data area of the .STF if corrupt.   | Download & reinstall the .SFT file                                   |
| E16: CB write CRC   | The unpacked controller firmware file did not write correctly.  | Try again  |
| E17: CB position  | The controller part of the .STF file could not be accessed  | Download & reinstall the .SFT file                                   |
| E18: HMI data size  | The size of the HMI data in the .STF is not correct   | Download & reinstall the .STF file                                   |
| E19: HMI read CRC   | The HMI data is corrupt   | Download & reinstall the .STF file                                   |
| E20: HMI baud rate  | The HMI connection speed could not be established   | Turn off and restart the SuperTrickler                               |
| E21: HMI file position  | The position of the HMI data could not be found   | Download & reinstall the .STF file                                   |
| E22: Cannot downgrade   | The current version does not allow for a downgraded version   |  |
| E23: extra write size   | The unpacked extra file did not unpack to the correct size.   | Check SD disk format or disk space                                   |
| E24: extra read CRC   | The data area of the .STF if corrupt.   | Download & reinstall the .SFT file                                   |
| E25: extra write CRC  | The unpacked extra file did not write correctly.  | Try again  |
| E26: extra file position  | The extra file in the .STF file could not be accessed   | Download & reinstall the .SFT file                                   |
| E27: Creating extra file  | There was a problem creating the file that the extra file was unpacked into.  | Check SD disk format or disk space                                   |
| E28: ctrl firmware failed to load.<br>(or the light does not flash for a while) | The controller firmware failed to load from the SD card. The format of the SD card is very important. The max size is 32GB (FAT 32) | Use a compliant SD card formatted using the SuperTrickler and retry. |
| E29: creating proforma file   | There was a problem creating the proforma file.   | Check SD disk format or disk space                                   |
| E30: proforma write size  | The unpacked proforma file did not unpack to the correct size.  | Check SD disk format or disk space                                   |
| E31: proforma read CRC  | The data area of the .STF if corrupt.   | Download & reinstall the .SFT file                                   |
| E32: proforma write CRC   | The unpacked proforma file did not write correctly.   | Try again  |
| E33: powder.dbl position  | The powder.dbl part of the .STF file could not be accessed  | Download & reinstall the .SFT file                                   |
| E34: creating powder.dbl file   | There was a problem creating the powder.dbl file.   | Check SD disk format or disk space                                   |
| E35: powder.dbl write size  | The unpacked powder.dbl file did not unpack to the correct size.  | Check SD disk format or disk space                                   |
| E36: powder.dbl read CRC  | The data area of the .STF if corrupt.   | Download & reinstall the .SFT file                                   |

|                           |  |                                    |
|---------------------------|--|------------------------------------|
| E37: powder.dbl write CRC | The unpacked powder.dbl file did not write correctly.      | Try again                          |
| E38: powder.dbl position  | The powder.dbl part of the .STF file could not be accessed | Download & reinstall the .SFT file |
| E39: Sub Header CRC       | The Sub Header data area of the .STF if corrupt.           | Download & reinstall the .SFT file |

In most cases when an error occurs, reinstall the sft on to the SD card again and try again.

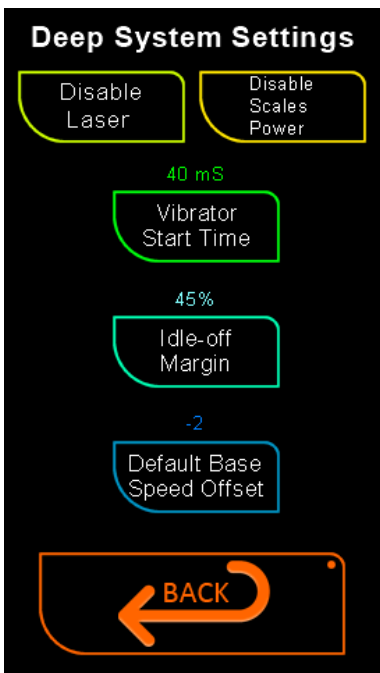

**Disable Laser:** Completely disable the laser and its subsystem.

**Disable Scales Power:** Used to disable the output of power to the scale from the SuperTrickler. Allows usage of the PSU from the scale. **CAUTION: Do not mix up the two power supplies, they are different polarity!**

**Vibrator Starting Time:** Used to change the initial starting burst to the vibrating motor. Generally, 40 milliseconds is adequate to get the motor started. If your motor is not starting, try increasing this by 5 or 10 milliseconds at a time.

**Idle-off Margin:** During a charge cycle, the vibrator motor is optionally not turned off, avoiding the possibility of burping your powder from motor starts. Instead, the motor will be sent to an idle speed. The idle speed is a percentage below the minimum vibrator setting. This setting should generally be around 40-50%. If set too high, the motor may stall, resulting in the unit failing to complete a charge. If set too low, it may be very difficult to gain consistent control of the powder drop when the vibrating tube is in use.

**Default Base Speed Offset:** When making changes to the profile default, the vibrator settings are unavailable. For this reason, we have placed the default vibrator base speed offset in the deep settings section. If you find that your default base speed offset consistently needs changing, you can adjust the default value here (see Vibrator Speed Settings in the profile section).

## Charge Log Files

The data logging ability of the SuperTrickler is an important feature. There are two main log files stored on the micro-SD card under a folder called \log. The files are Comma Separated Values (CSV) files, which can be opened on any spreadsheet program or text editor.

The log file size is limited to 3.9 gigabytes (an enormous amount of data), however it is recommended from time to time to back the files up and remove them as they grow too large (see Data Log File Backup below).

**Note:** If you remove the files, the SuperTrickler will recreate the missing files.

For successful loads, the file is called “\log\loads.csv”. There are 2 formats available for this file. One saves some space by only writing the powder, batch and total powder used when the profile is changed. The ‘log every line’ format logs this information on every line. The file has the following standard fields:

**Date, Time, Preset, Powder, Batch, Powder Used, Volume, Setpoint, Charge, Tolerance, Error, Consecutive, Fill Time, Process**

Date is the date the charge occurred.

Time is the time of the charge.

Preset is the preset used to create this charge.



Batch is the batch value, if set.

Powder Used is a running total of the powder used for successful loads since the powder or preset was changed.

Volume is the volume of the cartridge set under pre-sets if it has been set.

Setpoint is the target charge weight.

Charge is the actual charge weight.

Tolerance is the tolerance setting for this charge.

Error is the difference between the Setpoint and the actual charge loaded.

Consecutive is the number of charges since the last error.

Fill Time is the time it took to create the charge. Note: this does not include the 'final' analysis time.

Process is a coded string contain AI information on how the load was made.

**NOTE:** if you desire extra fields for your own records, you can edit in extra headings using spread sheet software or a text editor AFTER you save the log file locally on your computer.

For failed loads, the file is called \log\analysis.csv. The analysis file logs failed loads and optionally all loads (if "Log all Charges in Analysis" is selected). It contains all the same fields as the successful loads (mentioned above) but provides more extensive information that can be used by our support team to analyze the reasons why the failed load occurred.

A single or rare failed load is not of particular interest to the support team. However, if you are continually having trouble, this file can be emailed to our support team.

[support@supertrickler.com.au](mailto:support@supertrickler.com.au)

## Log File Backup

Backing up your log files is recommended from time to time, using a laptop or personal computer. Note: You may need a Micro-SD to SD card adapter if your computer does not directly support Micro-SD cards.

1. Remove the Micro-SD card from the SuperTrickler (press down, release, then remove).
2. Insert the card into your computer.
3. Navigate into the Log folder.
4. Copy the .CSV file to a location on your computer.
5. If a file is getting large (nearing the 3.9GB limit) it is recommended to remove the large file, the SuperTrickler will recreate a new file automatically when the card is reinserted.
6. Once the backup has completed, reinsert the card back into the SuperTrickler (press in until it clicks).

User Notes...

## Powder Profile *Menu, Start, Profile*

The Powder Profile is a collection of information that defines the characteristics of the powder (or pre-set). The SuperTrickler uses this profile to control the powder dispensing process.

While the numerous settings in the Powder Profile may initially seem overwhelming, most users find the primary settings intuitive after minimal experience. Many settings have adequate defaults, and the Artificial Intelligence (AI) self-learning feature simplifies the initial setup. The trade-off for this complexity is the SuperTrickler's exceptional speed and versatility in handling diverse powders.

The SuperTrickler can dispense with remarkable speed, but this requires detailed information about the powder's properties. Unlike many machines on the market, which sacrifice complexity for simplicity and limit their effectiveness with certain powders, the SuperTrickler avoids such compromises.

Additionally, the SuperTrickler maintains a database of every powder or pre-set profile, eliminating the need to repeat learning, calibration, or setup processes when switching powders.

Each powder and pre-set has its own profile, beginning with a default configuration designed for AI self-learning to handle most of the work. This allows you to start dispensing quickly, though you can further adjust settings to optimize speed or consistency as needed.

**Note:** do not expect 100% successful charges unless you want to trade dispensing speed for time.

### Terminology

- **AI:** Artificial Intelligence – a system that uses weighted factors in relation to the information at hand to create an outcome.
- **Tubes / Trickler:** The physical trickler tubes, the rotating bulk tube and the vibrating fine tube.
- **Instrument:** How the system uses a given tube to deliver powder. Bulk, Fine, Slow & Pulse.
- **Speed:** How fast an instrument is rotating or vibrating.
- **Ramp:** To change the speed smoothly up or down.
- **Inflight:** is the powder that has left the tube but not yet landed in the receiving powder cup.
- **Setpoint Offset:** Changes the instrument target to the charge setpoint less the offset (creates a new instrument setpoint).

At the core of the SuperTrickler, separate AI engines that work together to deliver you a result.

1. **AI Orchestrator:** supervises the charging operation.
2. **AI Self-Learning:**

This feature learns from mistakes identified by the **AI Orchestrator**. Even when disabled from making automatic adjustments to the profile, the self-learning process continues running in the background. It provides data and insights to assist operators in manually fine-tuning the profile.

### Sequencing

It is important to understand that the SuperTrickler does not follow a fixed dispensing sequence, as you might have seen in other systems. The AI dynamically assesses the progress of each charge and may switch instruments or dispensing methods at any point during the process.

Each instrument is designed to deliver the correct amount of powder. However, since increased speed can lead to inaccuracies, the AI Orchestrator evaluates the performance of each instrument.

If one fails to deliver the exact amount, the AI selects the next instrument to compensate for the shortfall.

As you begin to understand how the AI operates, you can fine-tune the profile settings to achieve optimal results for your specific needs. The AI Orchestrator does not have the ability to visually or physically observe the powder or the dispensing process; it relies on data inputs, which are relatively "blind." This is where your observations and manual adjustments can significantly assist the Orchestrator in refining the process.

It's important to note that operators have different priorities. Some prioritize consistency, even if it takes more time, while others prioritize speed, accepting a higher rate of overcharges. Preferences can range from extreme precision to more moderate tolerances. The AI cannot read your mind or intuitively know your preferences—it relies on your input to tailor the SuperTrickler's behaviour for a given powder.

Powder and grains are notoriously difficult to dispense accurately. Some powders stick and clump, while others flow freely like water. Most dispensers on the market adopt a "one-size-fits-all" approach, compromising on control systems to accommodate a wide range of powders. While this generally works well, the SuperTrickler takes it a step further by allowing you to fine-tune settings for each powder. These settings are saved, so you don't have to repeat the process the next time you use the same powder. This feature gives operators unparalleled control over the SuperTrickler's performance across a wide spectrum of powders.

However, not everyone wants to be a super-user or fine-tune every detail. This is where the AI self-learning feature shines. It adds a new dimension to powder dispensing by dynamically analysing the powder's characteristics and learning from its mistakes. It's important to understand that the AI self-learning is not designed to optimize the system perfectly but rather to find a balanced middle ground where most charges are consistently accurate, with minimal overcharges.

Ultimately, the operator is the best fine-tuner, as only they know their specific priorities and tolerances. For many users, however, simply selecting the powder from the list and letting the AI self-learning handle the rest will be more than sufficient for their needs.

## Control System Philosophy

To optimize the results from the SuperTrickler, it is advantageous to understand its control system philosophy. Similar dispensers on the market typically use either a Proportional Integral Derivative (PID) controller or a simple Proportional Sequenced Controller. However, we have chosen a different approach by incorporating artificial intelligence (AI) into multiple aspects of the operation.

Proportional controllers face a fundamental limitation: they rely on the reaction speed (how fast to run) as a proportion of the error (how much more to dispense). As you get closer to the target, the error decreases, resulting in a smaller reaction. Theoretically, a proportional controller alone can never reach the target because the reaction diminishes to near zero as the target is approached. To address this, most systems implement solutions such as setting a minimum speed or aiming slightly above the target set-point. While these methods work exceptionally well, proportional controllers inherently require time to achieve accurate results.

In contrast, the SuperTrickler uses AI to evaluate and adjust each dispensing attempt in real-time. Instead of following a fixed sequence, the AI Orchestrator dynamically assesses the results of each instrument's attempt and reacts accordingly. Unlike proportional control systems, the SuperTrickler's aiming set-point is always at the lower end of the tolerance range. This approach

increases the risk of overthrows but offers significant advantages in speed and flexibility. Operators can choose faster dispensing times with a higher reject rate or opt for slower, more conservative times with minimal or no rejects. The balance between speed and accuracy is entirely at the operator's discretion, allowing for precise control over the parameters.

## Inflight Concept and Inflight Tracking

**Inflight** refers to the material still in the air between the end of the tube and the powder cup after the trickler instrument stops. This value is critical for the dispensing process.

The inflight tracking system monitors the amount of inflight material and processes the results through either an **Agile** average mean filter or a **Sedate** exponential filter to refine the actual inflight amount during the dispensing session. This system also compensates for changes in powder characteristics as the hopper level decreases. Before filtering, a percentage-based deadband can be implemented to prevent small fluctuations from affecting the inflight tracking amount.

It's important to note that inflight tracking does not provide an instantaneous value. The data is filtered, and at the start of a session, the system uses the inflight value for the instrument. It may take a few charges to establish a usable value. The inflight tracking value is displayed in grey above the set inflight value for each instrument and serves as the working value for inflight during the session.

**Important Note:** The inflight controls do not directly control the inflight amount. Instead, they set the base value at the start of a session, which the system uses to determine when to turn off the motor.

## Inflight Tracking Filtering

Each instrument (except the pulse) has a separate inflight tracking filters. The purpose of these filters is to use the last measured inflight value of the powder drop and apply a modified or smoothed value to the inflight tracking. The system offers two different filtering methods, and each instrument has a selection switch that allows the operator to choose the best filter for that specific powder. Without filtering, the system would be chaotic, as no two inflight amounts are exactly the same. Therefore, we need to smooth out the values or consider the likely worst-case scenario so that the system aims to drop at or just inside the target point.

**Agile Filtering:** This method uses the maximum value found in the bell curve of a median range (9 samples, with 7 of them used in the bell curve range); the highest value is used for the inflight tracking value. The advantage of this filter is its speed of response to changes; however, it may be subject to a small increase in overthrows, and some setpoint offset might be required with the Bulk and Fine modes.

**Sedate Filtering:** This method employs a biased exponential filter to gradually adjust the inflight tracking amount. It responds to large inflight amounts much faster than to small inflight amounts to avoid overthrows. The sedate filter first utilizes the agile filter's median range to filter out extreme values, then applies the result to an exponential filter. The sedate filtering system has the advantage of avoiding more overthrows compared to the agile filtering system but is much slower in responding to changes since only a proportion of the overshoot or undershoot is applied to the

existing inflight tracking value.

**Deadband:** This is a percentage (0-100%) range within which, if an inflight value falls, the system will ignore the reading, thereby not affecting the inflight tracking value. A 10% deadband means 10% above and 10% below the current inflight tracking value. Some users prefer to disable the inflight tracking function, finding it more of a hindrance than a help. The inflight tracking feature is designed to adjust for changes in hopper powder levels over time, which affect the pressure and consequently the powder flow to the tubes. However, with continuous changes in Bulk, Fine, and possibly Slow inflight tracking, these adjustments can counteract each other, adversely impacting overall performance.

## Vibrator Speed Settings

**Important:** This setting must be set when an un-profiled powder or preset is selected. It should be checked at the start of a session and periodically during a large loading session. For better stability, it is recommended to warm up the vibrator mounting rubber by running the vibrator without powder before setting or adjusting the vibrator base speed at the start of a loading session.

**VERY IMPORTANT:** The correct setup of the vibrator setting is critical. Failure to do this correctly may result in the artificial intelligence self-learning being able to achieve stable results.

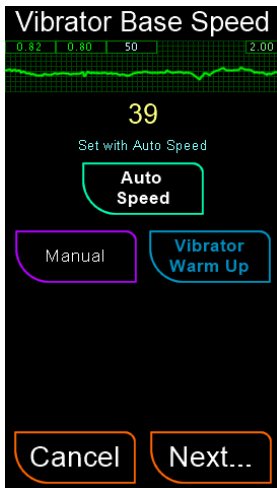

The top of the screen shows the flow information (see [Powder Flow Graph](#) information below).

Generally you would always use the Auto Speed and let the system automatically adjust the base speed.

The process is a two-step process. Firstly, set the vibrator base speed via the automatic system (PREFERRED), or by manual adjustment. The next step involves setting the High Speed Limit. The High Speed Limit is the maximum speed that any instrument can obtain.

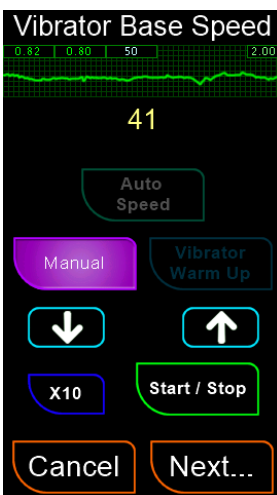

You can also use the **Manual** setting to adjust the screen until you achieve a weigh increment of roughly once every second. Once you've reached this point, stop the motor and reduce the speed by 5 units to optimize the control system's range.

Press the **Start/Stop** button to operate the motor. To adjust the speed, use the **Light Blue down and up arrows** to change the speed's minimum value. Always allow time for the flow to stabilize before finalizing the settings. This range can be any value between 1 and 255, with the current value displayed in yellow.

The **blue** unit button will toggle the value of the arrows between increments of **x1** and **x10**.

## Stage two – the vibrator high speed limit

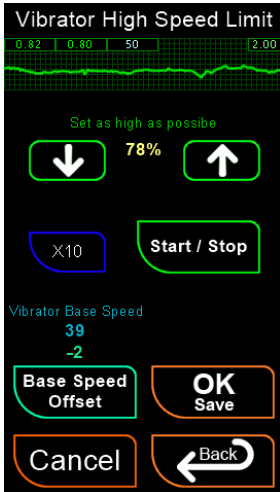

The vibrator high-speed limit sets the speed limit for any instrument that uses the vibrator.

Press the **Start/Stop** button to start the vibrator and adjust the speed up or down to obtain the optimal speed without causing powder to bounce out of the cup. The ideal smooth flow rate should be around 0.10 - 0.12. The value range is between 1 and 100%, and it is not uncommon to have a limit value of 100%.

The **blue** unit button will toggle the value of the arrows between increments of **x1** and **x10**.

When completed, press the OK/Save button to lock in the values.

### How to set the Vibrator Speed Settings step by step.

**STEP 1.** Ensure the hopper has an adequate amount of powder and the powder cup is in position under the trickler tubes.

**STEP 2.** Press the 'Auto Speed' button; this will initiate an operation that will start the vibrator tube, initially running slow then ramping up before it begins reducing the speed until the flow rate is around the 1 or 2 seconds between kernel drops. Wait for the system to stop by itself.

**STEP 3.** Once step 2 has been completed the system will automatically take you to the next screen to set the Vibrator High Speed Limit.

**STEP 4.** Press the 'Start / Stop' button, allowing time for the tube to build up material (**do not rush**), then while it's running, use the green arrow keys to adjust the speed up or down as required to achieve a smooth flow rate around 0.10 - 0.12 and ensure that no powder is bouncing out of the cup. You can use the BLUE range key to change the arrow steps from between X1 and X10 per step.

**STEP 5.** When satisfied, stop the motor and press the OK Save button to lock in the settings.

**NOTE:** Temperature and other factors can change the vibration characteristics, so you can revisit these settings as often as you like.

### Vibrator Base Speed Offset

This system only applies to the Automatic Base Speed Setting and is disabled if manual settings are used. This offset adjusts the value of the Base Speed to ensure that the system can reduce the speed to a point where the vibrating tube can operate without delivering powder..

**Important:** The optimal value for a given powder is undefined. Trial and error is the best method to determine the best value. If the system, particularly the pulse, struggles with a given powder, you



can change this value initially by 2 or 3 units up or down and then observe the results. If the system behaves better, you can fine-tune the value. If the system behaves worse, you can change it in the opposite direction.

### When does the offset apply and how does it work

At the end of the Automatic Base Speed detection the offset is automatically applied to base speed value. From the base speed setting the system will automatically take you to the high speed limit setting where the ability to change the offset can be carried out.

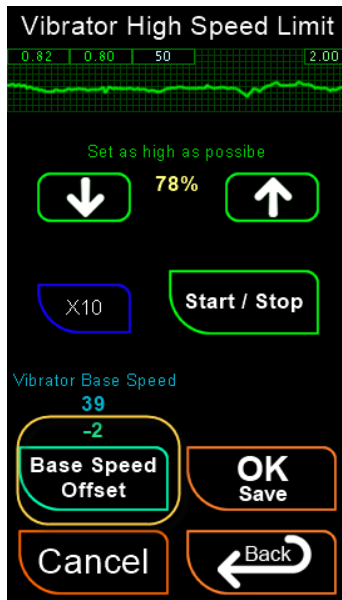

From Vibrator High Speed screen, the Vibrator Base Speed is shown along with the offset value. The base speed is displayed with the offset value applied. In the event you choose to change this value, pressing the Base Speed Offset button will enable a new value between -20 to 0 to be applied. If you fail to make the value a negative number, the system will convert it automatically. An out-of-range value will result in the default offset being applied.

**Important:** The offset can be changed at any time without the need to redo the base speed. The change will be applied to the actual value recorded and not the displayed value. For example, if the displayed value is 39 with an offset of -2, and you change the value to -3, the resultant value will be 38.

## Instruments

Instruments determine how a given tube is used concerning a set of parameters. Apart from the pulsating instrument, all other instruments can be turned off by setting their speed to zero.

- **Bulk:** A rotation tube designed to dispense a large amount of powder as quickly as possible. Note: The Fine Tube is used temporarily during this process to ensure the tube is primed and ready for use (if required).
- **Fine:** A vibrating tube designed to dispense any shortfall from the bulk instrument, also as quickly as possible. This instrument operates at both high and low speeds. Nearing the target weight, it will ramp down from high to low speed. The purpose of this ramp down is not proportional control but rather to de-load the vibrating tube (i.e., reduce the powder loading in the tube) to prepare for any subsequent instruments, if necessary.
- **Slow** (not generally used): This instrument runs the vibrating tube at a constant speed to compensate for any shortfall left by the previous instruments. Generally, if the Fine is set carefully, the slow instrument is not required and, as such, is defaulted to the off state.
- **Pulsating (Pulse):** Uses the vibrating tube, running a complex cycle of pulsing (On/Off) until any shortfall from the previous instruments has been fulfilled. It cannot be disabled.

To help you set the speeds for the instruments, there is a handy tool under the profile pages of each instrument that allows you to test-run the tubes and physically observe and set the speeds to achieve a desirable powder flow. The AI self-learning system will attempt to adjust the speed of the Fine instrument unless they have been set manually, in which case a message "Self-learning speed locked" will appear on the profile screen to indicate this effect.

## Profile Variables

The powder profile is a container of variables that instruct the control system on how to react during the dispensing process. These variables are grouped into logical sections to reduce overall complexity:

- **Basic** – Tolerance, final stabilisation.
- **Delivery Instruments** – Bulk, Fine, Slow, and Pulse.
- **Self-Learning**.

Initially, all these settings can seem overwhelming. Be patient and be prepared to read the relevant sections several times while adjusting the instrument settings. To aid in reducing complexity, the system can be set to "Simple" which reduces the number of active controls displayed, to only the essentials. The key to success in fine-tuning is to look at trends rather than focusing on a single powder drop. Understand the settings you are changing—don't just assume you know what each does. Take the time to read and review the functionality of each setting, and soon you will become very comfortable in resolving problems and fine-tuning your SuperTrickler to your satisfaction. Let's proceed to the profile screens with a description of the variables and their functionalities. The opening screen presents a menu that allows you to choose the section you require

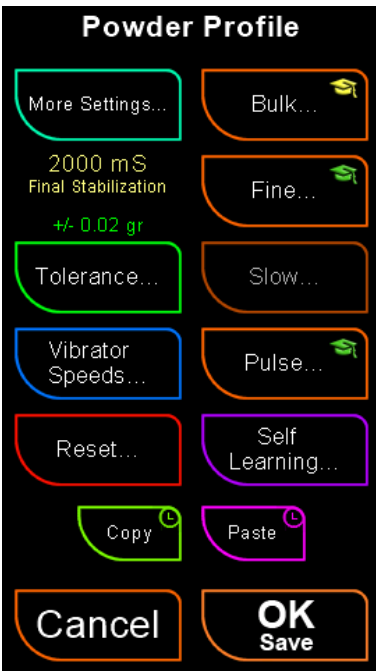

**More Settings:** Final stabilization time, simple mode, powder level alert, vibrator off mode and charge stop mode options.

**Tolerance:** Set the tolerance level and type.  
Note: A small green flashing dot, top left of the tolerance button indicates that the profile tolerance is anything other than the standard +/- 0.02

**Vibrator Speeds:** Vibrator speed settings (critical setting).

**Reset:** Reset selection menu.

**Bulk, Fine, Slow & Pulse:** Instrument settings.

**Self Learning:** The self-learning settings and the ability reset individual instruments separately.

**Copy:** Copy the entire profile to the clipboard (there is only 1 clipboard).

**Paste:** Paste the profile that is in the clipboard to the current profile.

**Cancel:** Will cancel any changes to the profile with the exception of the vibrator settings, then return you to the charge screen.

**OK Save:** will save all changes made to the profile and return you to the charge screen.

**Note:** The **Copy/Paste** function is useful for several purposes. Examples include:

1. **Saving the Current Profile:** Save the current profile, allowing you to experiment with it. Then, restore it if things go wrong!
2. **Creating a New Preset:** Save a profile and create a new preset that you think will be very similar (perhaps with the same powder but a different charge point). Then, recall this profile into the new preset.

## More Settings

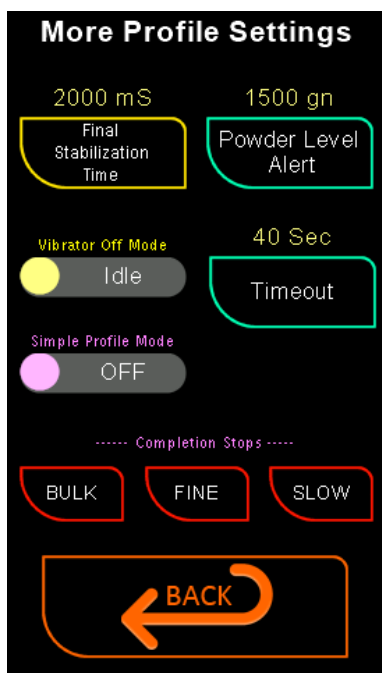

**Final Stabilization Time:** This critical time, measured in milliseconds (1000 ms = 1 second), is the delay at the end of the charge. It allows the scale to stabilize (settle) before determining whether the charge needs more powder, is within tolerance as a successful charge, or should be rejected due to an overshoot. If this value is too low, you may find that charges result in undershoots. Conversely, if it's too long, unnecessary time is wasted. Generally, one to two seconds (1000 to 2000 ms) is appropriate. However, for fine grain powders, this value could be reduced; for large grain powders, the value may need to increase due to vibrations the heavy grains create in the delivery powder cup and scale.

**Note:** A&D recommends allowing the scale at least one second to stabilize.

**Powder Level Alert:** Refer to the [hopper powder level alert](#) section, which sets the amount of powder that will trigger a hopper powder level alert. The default setting is either OFF or 1500 grains and can be adjusted to any value.

### Guide to Hopper Volumes:

- It takes approximately 700 grains to cover the powder baffle at the bottom of the hopper.
- If the powder is 75mm (3") below the top, there are approximately 2000 grains in the machine.
- If the powder is 50mm (2") below the top, there are approximately 4000 grains in the machine.
- If the powder is 25mm (1") from the top, there are approximately 7000 grains in the machine.

**Timeout:** This option sets the time limit for a powder throw. If this time is exceeded during a single throw, the power throw will be automatically aborted.

**Simple Mode:** This option disables and simplifies the options within the profile that are typically used only by advanced users. It is solely a display function and does not alter any operational parameters.

**Vibrator Off Mode:** This controls how the system manages the vibrator motor when it is not required during a charge cycle.

If set to 'Idle', the vibrator (when not in use during a charge) will enter a low-power idle state instead of stopping completely. The advantage of this mode is that the vibrator motor does not require a start operation, which can sometimes cause a powder burp.

If set to 'Stop', the vibrator motor will come to a complete stop when not required. This was the system used in all versions until V2.40.

**Completion Stops:** This is a special fine-tuning option. When enabled for a given instrument, it will stop and abort the charge upon completion of the instrument's use. This feature is used to examine the instrument's characteristics and metadata information to fine-tune its operation for speed or consistency.

## Tolerance

Tolerance is the acceptable range of a given charge. The tolerance adjustment allows you to modify this range and how it is applied. If the tolerance is too tight, you may see a low success rate; however, it needs to be tight enough to ensure your loads are stable. There are two modes: **Standard** (tolerance either side of the setpoint) and **Custom**, which allows you to independently customize the amount below and above the setpoint.

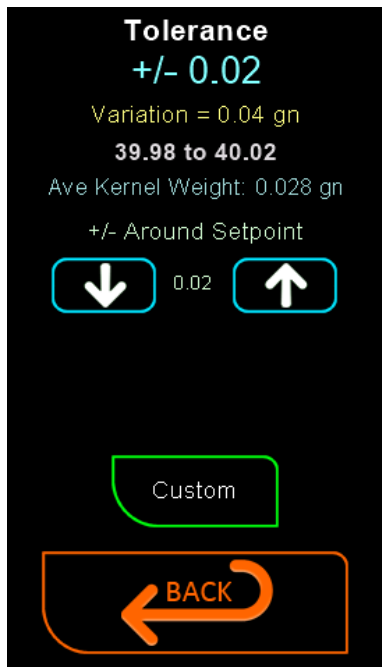

**Line 1:** The large text on the top line shows the selected tolerance configuration. In Blue for +/- either side of the setpoint and in Green for when the custom settings are used.

**Line 2:** The second yellow line shows the tolerance range or variation. You can see the +/- 0.02 gn yields a variation of 0.04 grains, 0.02 below and 0.02 above.

**Line 3:** The third white line in bold shows the charge range with the current setpoint.

**Line 4:** Shows (if known in the powder.dbl file) the average kernel weight of the selected powder.

**Down & Up arrows:** These buttons allow you to increase and decrease the tolerance bandwidth in steps of 0.02 grains.

## Custom Settings

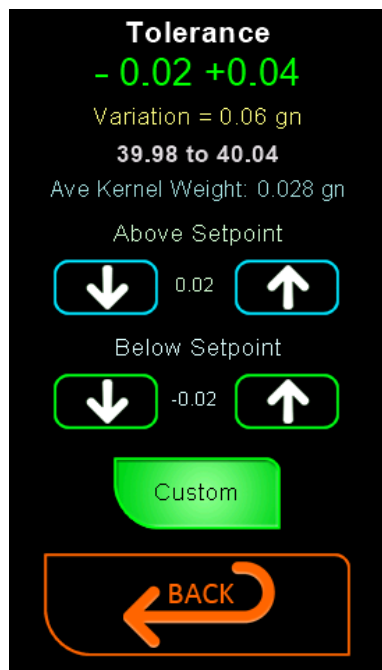

The custom settings allow you to choose the tolerance below the setpoint separately from the tolerance above the setpoint.

**General:** Giving the system a tolerance value of 0.00 or no tolerance is the re-loaders dream, however, it does come with a price in that you are going to get many rejected over charges. It is important to also understand that with some powders you may have individual grains that can weigh 0.06 grains or more. However, testing has shown that the powders average out and having a tolerance below the grain weight is still achievable, especially with larger charges.

**Rule of thumb:** Take 10 or 20 kernels and weigh them to find the average weight per kernel. Then multiply that average weight by 2 and set this as your +/- tolerance (round the result to the nearest 0.02, the scales resolution).

Example: Vihtavuori, N555 average weight = 0.024, (x 2 = 0.048) tolerance = +/-0.04 (range 0.08).

If you required a tighter tolerance, you can customise the above and below to a tighter value, ensuring you are allowing at least 1 kernel weight tolerance.

The Powder Database file contains many powder weights and when known will generally have the tolerance values preset for you. For large kernel powers, you may want to check the preset tolerance values suits your needs.

## Bulk Instrument

This screen has all the relevant parameters for the bulk trickler tube. This tube is directly driven by a rotating stepper motor onto the base of the tube. Its fundamental purpose is to dispense the bulk of the powder as fast as possible.

### Process of the Bulk Instrument.

The fundamental process is as follows:

1. The bulk instrument is evaluated as being suitable for the charge at hand., and if so then;
2. The rotating trickler is ramped up from 0 to the operating speed over time;
3. About half a second after it starts to turn, the vibrating trickler starts at Pulse speed to prime and stabilise (even out the powder) the tube for later use;
4. The flow rate is monitored and about 1 second before the rotating trickler is due to stop the vibrating trickler is switched to idle-off speed;
5. When the weight reaches the aim-point (set-point minus the bulk inflight) the rotating trickler stops;
6. The results of the instrument usage are evaluated.

### Bulk Instrument Parameters

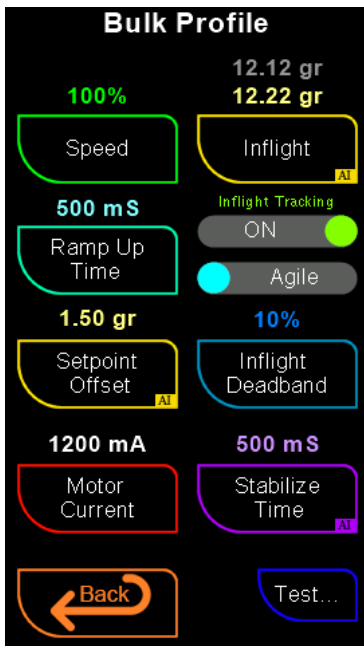

**Speed:** This is the rotation speed from 0 (off) to 100%. It is important to understand that although 90% is the default setting, this may not be the best speed for your powder. Powders that do not flow well may clump and tumble inside the tube, and slowing it down may provide a more consistent output. The more consistent the output, the better the system will run, as it can more accurately predict the inflight powder amount, resulting in the bulk dispensing very close to, or at, the target weight.

If the bulk instrument is not required, setting the speed to zero (off) will disable its use.

**Ramp Up Time:** The bulk trickler motor is a hefty motor, and to avoid putting a large strain on the components when the motor starts, a soft start or ramp-up is used. This defines the time it takes to go from zero speed to the set speed. You may want to slow this down with heavy powders or speed it up with light powders. While a setting of 0 milliseconds is acceptable, it is not recommended with heavy powders.

**Setpoint Offset:** Initially this is set by the AI self-learning system, setting it as such that it leaves enough room for the Fine Instrument to operate properly. The Setpoint Offset shifts the aim point from the setpoint by a specified amount. For example, if the setpoint is 40.00 and the Setpoint Offset is 2.00, the bulk motor will aim to stop at 38.00. There are several reasons to use this offset. If the bulk tube gets close to the target but not exactly on it, and the remaining weight doesn't leave enough room for the fine instrument to start, resulting in a regular long pulse time, you may want to offset the bulk to stop sooner. This will leave enough room for the fine instrument to start and get closer to the mark before the pulse has to kick in. This can also be useful if a short stabilization time is set, allowing the fine instrument to start before the weight has stabilized without affecting the process decision-making.

The scale data (relatively speaking) arrives slowly and is unstable as powder falls into the cup, causing vibrations and resonances. Combined with the unstable flow of powder, this creates a very unreliable stopping point for the operation instrument. As a result, the inflight value can differ for every powder drop. Like the overall tolerance, having some leeway in the system is beneficial. The setpoint offset essentially acts as the Bulk tolerance. It tells the control system to stop short of the setpoint and let the subsequent instrument manage the remaining charge.

If the setpoint offset is too small, the system is more likely to overshoot, resulting in a rejected discharge. If you are chasing speed, keeping this small or at zero can be advantageous **but at the expense of consistency**. If the setpoint offset is too large, the system is more likely to undershoot, resulting in a significant remaining charge to be filled by the subsequent instrument. The net result will be consistency at the expense of speed (slow charges).

The rule of thumb is: Set this to  $\frac{1}{4}$  (25%) of the Bulk Inflight value.

**Motor Current:** Powder comes in many shapes and sizes, which can place varying strains on the motor and components. The setting can be adjusted between 500 mA and 2000 mA (0.5-2 A). A higher value will compensate for heavier powders, while lower values can be set for more manageable powders. The default is 1200 mA. If the bulk trickler tube stalls (fails to rotate), this value can be increased to compensate. Values below 1400 mA are shown in white and are considered low current settings. Values of 1400 mA or above will display in red, indicating high current settings. The higher the current, the noisier the motor will run, and it will put more strain on the motor and components, potentially causing a shutdown due to thermal overload. This will result in the motor shutting off for a few seconds while the components cool down. Hence, the lower the setting, the better.

**Note:** Changing the motor current does not affect speed or any other characteristic and is only used to overcome motor stalling or straining.

**Inflight:** (option) The inflight amount setting is most often initially set by the AI self-learning, but it can also be manually configured based on the value shown in the metadata displayed on the charge screen. For more information, review the [inflight section](#).

**Inflight Tracking:** This option allows you to choose between the system using the inflight tracking value (recommended) or using the value set in the inflight value. The system offers a filter selection between Slow or Fast. For more information, review the [inflight section](#).

**NOTE:** If the Stabilize Time is set below 500, the inflight tracking will be disabled. This is due to an inadequate amount of time to gauge a meaningful result from the scale.

**Inflight Filter Type: Agile/Sedate:** Selects the type of filtering used to manage the inflight tracking. Agile is a fast response median filter, whereas Sedate is a slow exponential filter. For more information, review the [inflight section](#).

**Inflight Deadband:** This control sets a deadband to filter out minor variations in the inflight tracking amount, resulting in a more stable inflight tracking value. The value can range from 0-100%, where 0 allows all variations to be included in the inflight tracking, and 100% prevents any variations from being included. In general, we recommend a value between 0-10%. For more information, review the [inflight section](#).



**Stabilize Time**: This setting controls the amount of time, in milliseconds (1000 ms = 1 second), given to allow the scale to stabilize (settle) before evaluating the results. The AI generally sets this value by monitoring for a stable reading after the bulk has initially completed its powder drop. Ideally, this time should be at least one second. However, practical testing has shown that around 500 milliseconds is usually adequate even down to as low as 200 can be effective. If the time is too short, another instrument may engage in a manner unsuitable for the remaining charge. If the time is too long, unnecessary time is wasted. For power users seeking speed, you may want to set this very low, around 100. If you choose to do this, it is recommended to increase the 'Setpoint Offset' value to compensate for the reduced time if required.

Note: When the time is set below 500 milliseconds, the inflight tracking will be disabled, as there will still be powder in flight when the next instrument starts.

**Test**: This will take you to a page that will allow you to test the bulk speed. From this page you can run the motor and adjust the speed while observing the behaviour of the powder flow.

**Test Page Motor Current**: The test page includes an option to automatically set the motor current by pressing the [Auto Motor Current](#) button. When this button is pressed, the speed will be set to 100%, and the motor will start at the lowest current setting. If the motor stalls, it will be turned off, the motor current readjusted to a higher value, then restarted. This process will repeat until a stable current is found or the maximum is reached.

## Fine Instrument

The purpose of the fine instrument is to rapidly compensate for any shortfall left by the bulk instrument, if used, or to quickly fill smaller charges when the bulk instrument is not used.

A vibratory system differs significantly from a rotating trickler tube. In a rotating tube, changing the speed results in a relatively instantaneous change in powder flow. However, a change in the speed of a vibrating trickler tube does not yield an instantaneous change in powder flow, as the amount of powder in the tube results from the previous speed of vibration. Nevertheless, the vibrating trickler tube has the significant advantage of being able to dispense very precise amounts of powder.

### Process of the Fine Instrument.

The fundamental process is as follows;

1. The fine instrument is evaluated as being suitable for the charge at hand, and if so then;
2. The remaining weight is evaluated and a decision for a start speed from between the high-speed setting and the low-speed setting is calculated;
3. The vibrating trickler moves from its off or idle speed toward its High Speed;
4. At the aim-point weight, less the ramp down weight and the Low Speed Final Phase weight, the vibrating speed will begin to be reduced down to the low-speed setting;
5. When low speed is achieved, the tube will remain running at the low speed for the Final Phase.
6. When the weight reaches the aim-point the vibrating trickler will return to off or idle;
7. The results of the instrument are evaluated.

### Fine Instrument Parameters

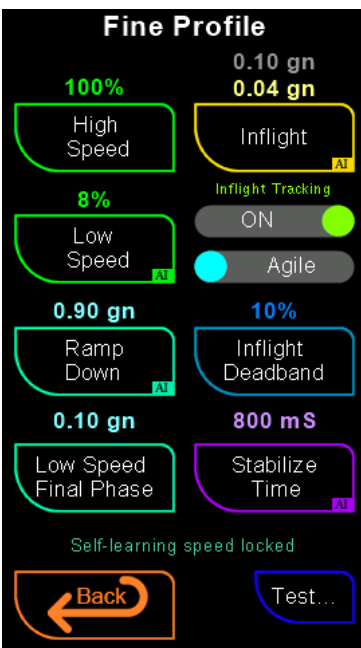

**High Speed:** This is the maximum speed as a percentage that the vibrating trickler operates. **Note:** this speed is not changed by the self-learning system, however is initial setting of the Vibrator High Speed Limit (the fine will be set to 66.6% of the high speed limit). Setting the speed to zero will disable the use of the fine instrument. See the tips below for more details on configuring this setting.

**Low Speed:** This is the minimum speed as a percentage that the vibrating trickler will operate at the end of the ramp down. **Note:** this speed is changed by the self-learning system, unless locked. Setting the speed to zero will also disable the use of the fine instrument.

**Ramp Down:** This is the weight before the weight aim-point is reached, when the vibrating trickler will begin slowing down. If this is too small, the fine instrument may overshoot the aim-point. If this is too large, the trickler will take unnecessary time to slow down. To manually set this value as a rule of thumb, take the BULK inflight measurement and divide it by 8 as a starting point for the fine ramp-

down.

**Example:** If the Bulk inflight is 7.78 grains, then  $7.78 / 7 = 1.11$ , which can be rounded to 1.10 grains.

Trim the ramp down for speed (lower the ramp down) or consistency (increase the ramp down).

**Low Speed Final Phase:** This control is used to set the number of grains remaining after the ramp-down, during which the tube will run and hold at the low-speed setting. This adjustment helps

achieve a more stable inflight value and a more consistent de-loading of the powder, whether for slow or pulse operation as required. See the Fine Control Speed Operation diagram below.

### **IMPORTANT**

Unlike other systems where the ramp-down functions as a proportional controller, our system uses the ramp-down to de-load or clear the vibrating tube of excess powder in readiness for the slow or pulse, if needed. The ramp down and final phase work together to achieve a stable inflight result. The **Low Speed Final Phase** will need time to stabilize. If the ramp-down is too fast and too much powder is flowing when it reaches the final phase weight, the predictive weight mechanism may activate and halt the process prematurely, resulting in an inconsistent inflight amount. In general, we recommend a **Low Speed Final Phase** value of around **0.10 grains**; however, larger or more fluid powders may require a longer stabilization time (a higher grains value) than would a finer grittier powder.

## Fine Control Speed Operation

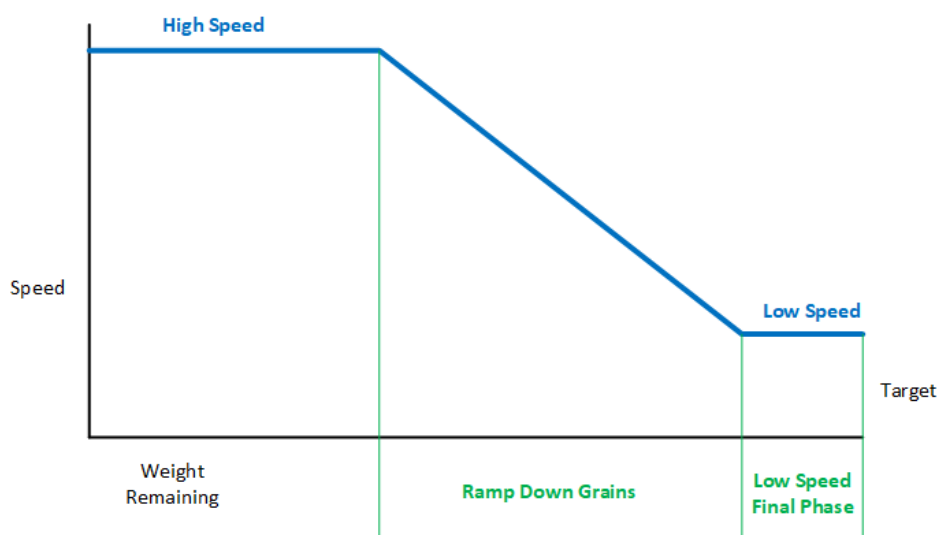

**Inflight:** The inflight amount setting, this is most often initially set by the AI self-learning, but can be manually configured based upon the value shown metadata displayed on the charge screen.

In general a good aim point for the fine inflight is a value of around **0.15** grains or less, use the low speed and ramp down control to achieve this inflight amount (this will significantly help the pulse operation). For more information review the [inflight section](#).

**Inflight Tracking:** (option) This option allows you to select between the systems, using the inflight tracking value (recommended) or using the value set in the inflight value. The system has a filter selection between Slow or Fast. For more information review the [inflight section](#).

**Inflight Filter Type: Agile/Sedate:** Selects the type of filtering used to manage the inflight tracking. Agile is a fast response median filter, whereas Sedate is a slow exponential filter. For more information, review the [inflight section](#).

**Inflight Deadband:** This control sets a deadband to filter out minor variations in the inflight tracking amount, resulting in a more stable inflight tracking value. The value can range from 0-100%, where 0 allows all variations to be included in the inflight tracking, and 100% prevents any variations from

being included. In general, we recommend a value between 0-10% For more information, review the [inflight section](#).

**Stabilize Time:** This setting controls the amount of time in milliseconds (1000 mS = 1 second), to give the scale time to stabilize (settle) before evaluating the results. The AI will generally set this value for you, by monitoring the scales for a stable reading after the fine has initially completed its powder drop. Ideally this time should be at least one second, however, practical testing has shown that in general around 500-800 milliseconds is adequate. If the time is too short, you may find another instrument will kick in operating in a manner unsuitable for the remaining charge, and if the time is too long, you waste unnecessary time. For power users seeking speed, you may want to set this very low to say around 300 mS, however it is recommended that if you do this you monitor it closely to be sure it is not too short.

NOTE: When the time is set below 700 milliseconds, the inflight tracking will be disabled, as there will still be powder in flight when the next instrument starts..

**Test:** This will take you to a page that will allow you to test the fine speeds. From this page you can run the motor and adjust the speeds while observing the behaviour of the powder flow. The test screen also has the speed lock option to disable the AI self-learning from touching the motor speed.

### *Setup Tips*

**High Speed:** In general, maintain a reasonably fast High Speed, considering how close the bulk is to the target and the amount of work required during the Fine phase. If the speed is too fast, the ramp-down might be ineffective (or require a longer ramp-down) and stability will be compromised, while too slow a speed will waste time. As a guide, 2/3 (66.6%) of the **Vibrator High Speed Limit** is a good starting point.

Allow time and settings for the Low Speed, Ramp Down and Low Speed Final Phase to give you stable result, with rare use of the pulse instrument. If using the controls you find its difficult to obtain fine stability then reduce the Hight Speed. See fine tuning below.

Set the **Low Speed** as slow as you can while maintaining a very slow, consistent flow. The goal here is to achieve a very low and consistent inflight value. Running at this slow speed is preferable to using the pulse mode, if possible.

Set the **Ramp Down** as described above, but make observations to ensure the **Final Phase** operates clearly. Keep the ramp as short as possible to avoid wasting time; however, if the ramp is too short, it will interfere with the final phase, leading to inconsistent inflight values and potential overthrows.

Set the **Low Speed Final Phase** (default is 0.15 grains) to ensure it runs long enough to achieve a fairly consistent inflight value. However, setting it too long will result in wasted time.

Fine turning the **High Speed:** Once everything is stable and the pulse is rarely or not being used, begin gradually increasing the High Speed. Remember to look for trends rather than focusing on the results of a single throw. Continue to incrementally increase the speed until you either reach the High Speed Limit or start encountering unstable results, overthrows, and higher usage of the pulse.

Ultimately, the amount and consistency of the Fine inflight powder is a combination of the **Bulk Offset, High & Low Speed, Ramp Down,** and the **Low Speed Final Phase**. The more consistent the

inflight, the faster your powder drop will be, as it will allow you to adjust the inflight down to the point where the pulse is hardly required.

## Slow Instrument

The slow fine instrument will not generally be used; however, it may have a purpose for some charges and powders. It can be used in conjunction with the Fine and Pulse instruments or can replace the role of either of these instruments.

The AI Orchestrator in its evaluation will generally follow this sequence:

1. Bulk Instrument if enabled and if suitable;
2. Fine Instrument if enabled and if suitable;
3. Slow Instrument if enabled and if suitable;
4. Pulse Instrument if enabled and if suitable.

### Process of the Slow Instrument.

The fundamental process is as follows:

1. The slow instrument is evaluated as being suitable for the charge at hand, and if so, then;
2. The vibrating trickler moves from its idle speed to the slow speed;
3. When the weight reaches the aim-point (set-point minus the slow inflight) the vibrating trickler return to idle;
4. The results of the instrument are evaluated.

### Slow Instrument Parameters

Note: The AI self-learning does not use the slow instrument or change any of the instrument settings apart from the inflight tracking.

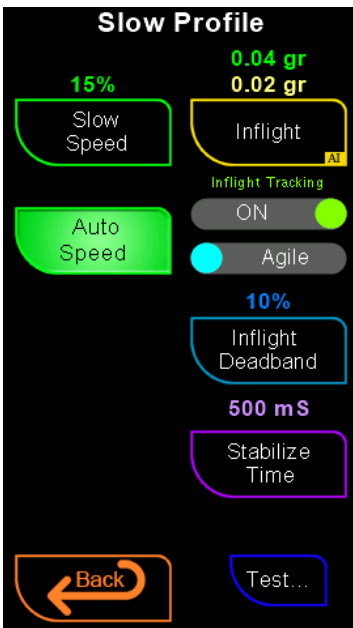

**Slow Speed:** This is the speed as a percentage that the vibrating trickler operates. **Note:** this speed is changed by the self-learning system unless locked. Setting the speed to zero will disable the use of the slow instrument.

**Auto Speed:** The system will attempt to keep the slow flow speed to around the one or two increments per second. Turning it off will use the fixed speed set by Slow Speed value and turning it on will use the initial slow speed setting however will change this value in order to keep the flow within the operational range.

**Inflight:** The inflight amount setting, this is most often initially set by the AI self-learning, but can be manually configured based upon the value shown metadata displayed on the charge screen.

For more information review the [inflight section](#).

**Inflight Tracking:** (option) This option allows you to select between the systems using the inflight tracking value (recommended) or using the value set in the inflight value. The system has a filter selection between Slow or Fast. For more information review the [inflight section](#).

**Inflight Filter Type: Agile/Sedate:** Selects the type of filtering used to manage the inflight tracking. Agile is a fast response median filter, whereas Sedate is a slow exponential filter. For more information, review the [inflight section](#).

**Inflight Deadband**: This control sets a deadband to filter out minor variations in the inflight tracking amount, resulting in a more stable inflight tracking value. The value can range from 0-100%, where 0 allows all variations to be included in the inflight tracking, and 100% prevents any variations from being included. In general, we recommend a value between 0-10% For more information, review the [inflight section](#).

**Stabilize Time**: This setting controls the amount of time in milliseconds (1000 mS = 1 second), to give the scale time to stabilize (settle) before evaluating the results.

**Test**: This will take you to a page that will allow you to test the fine speeds. From this page you can run the motor and adjust the speed while observing the behaviour of the powder flow.

## Pulse Instrument

The purpose of the pulse instrument is to carefully make up any shortfall left by the previous instruments used. The pulse instrument is the only one that cannot be disabled. If set up correctly, pulsing can deliver a small amount of powder down to a single grain. The downside of pulsing is that it takes time to release a quantity of powder, then stops and waits for it to land in the powder cup and be evaluated. The upside is that pulsing is very effective at giving a precise final finish to the charge.

The settings of the pulse system are the most complex. This complexity is necessary to manage the wide variety of powder characteristics in this delicate operation. Often, fine-tuning the pulsing system is a matter of trial and error, as there are no fixed rules for what will work best for the powder you are using in your specific environment.

### Dithering.

A phenomenon that can occur with a vibrating tube are standing waves, this usually occurs when the vibrations travelling wave and its reflections, caused by the powder become equal; the powder will simply stop flowing. The impulses created by the pulsing system are very susceptible to creating a standing wave and for this reason impulse dithering is introduced into the pulsing process where the system continually changes the speed, on and off durations to negate the creation of standing waves. The process is complex and has many factors however in simple terms the dithering is based around the process pulse process parameters and the weight remaining.

### Ramping.

The process of ramping is used to overcome cases where powder tends to burst out the tube rather than fall out a kernel or two at a time. Rather than turn the vibrator motor on from idle to the nominal speed, the ramping system will ramp the around ½ speed to the nominal speed over the pulse on period. When using the ramping function, you may need to increase the pulse on period. The system may choose to ignore the ramping even if it's turned on. Likewise, it may choose to use it even if turned off.

Note: When the pulse is a ramped pulse the display will lead the speed with a '/' eg Pulse /32%

### Process of the pulse Instrument.

The fundamental process is as follows:

1. The pulse instrument is evaluated as being suitable for the remaining charge at hand, and if so then;
2. The vibrating trickler is started from the normal off or idle speed to the pulse idle speed (if enabled).
3. It then changes the speed to the nominal speed for a short time measured in milliseconds;
4. Once the on time has been achieved or the scale has detected a change, the vibrating trickler will return to the pulse idle. A wait time measured in milliseconds is allowed to pass, allowing for the powder to fall into the cup and be accurately measured by the scale;
5. An evaluation is made and if the weight is still short of the aim-point, the process repeats until such time as the weight reaches the aim-point.

Looking at the image below you can see a typical powder drop, showing the pulse operation. The purple line indicates the ramping is enabled.



# TYPICAL CHARGE CYCLE OPERATION

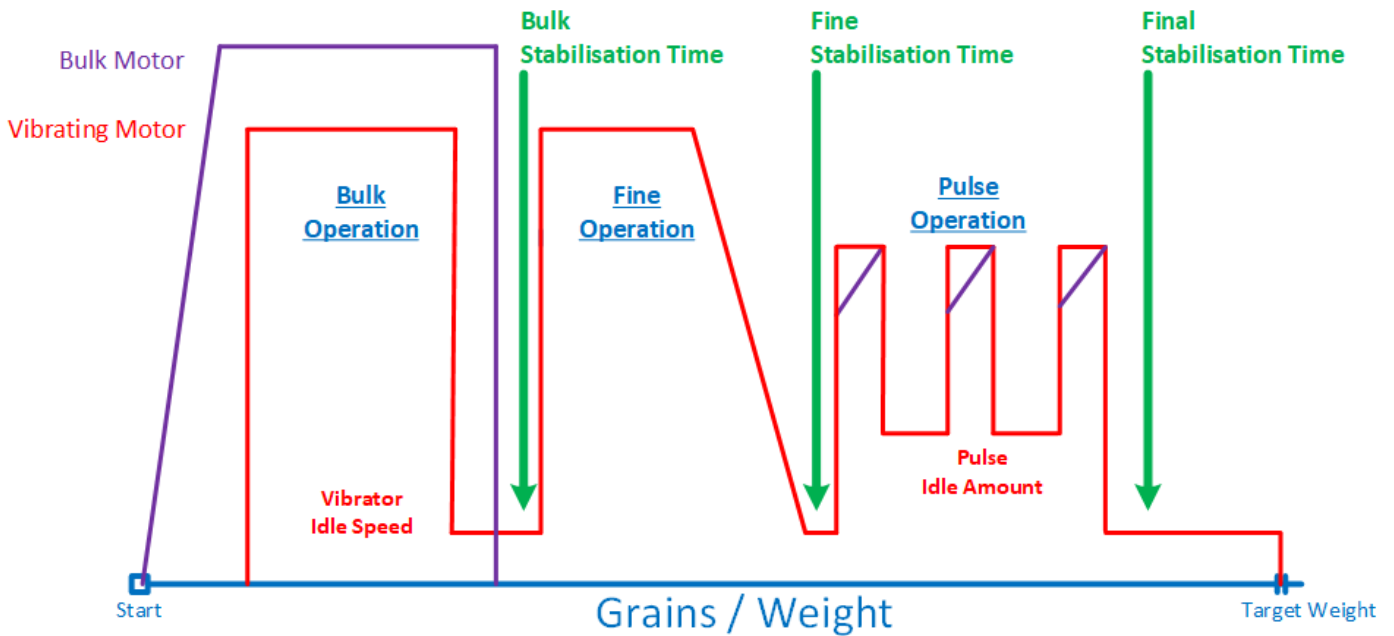

## Pulse Instrument Parameters

The instrument has 6 parameters and two options, in its operation as follows:

### Pulse Profile

|  |  |
|--|--|
| <div style="border: 1px solid green; border-radius: 5px; padding: 2px; text-align: center; color: green; font-weight: bold;">35%</div> <div style="border: 1px solid green; border-radius: 5px; padding: 2px; text-align: center;">Nominal Speed <span style="float: right; font-size: 0.8em;">AT</span></div>       | <div style="border: 1px solid green; border-radius: 5px; padding: 2px; text-align: center; color: green; font-weight: bold;">5</div> <div style="border: 1px solid green; border-radius: 5px; padding: 2px; text-align: center;">Idle Amount <span style="float: right; font-size: 0.8em;">AT</span></div> |
| <div style="border: 1px solid purple; border-radius: 5px; padding: 2px; text-align: center; color: purple; font-weight: bold;">135 mS</div> <div style="border: 1px solid purple; border-radius: 5px; padding: 2px; text-align: center;">Pulse Time ON <span style="float: right; font-size: 0.8em;">AT</span></div> | <div style="border: 1px solid green; border-radius: 5px; padding: 2px; text-align: center; color: green; font-weight: bold;">300 mS</div> <div style="border: 1px solid green; border-radius: 5px; padding: 2px; text-align: center;">Pulse Time OFF</div>   |
| <div style="border: 1px solid purple; border-radius: 5px; padding: 2px; text-align: center; color: purple; font-weight: bold;">Weak</div> <div style="border: 1px solid purple; border-radius: 5px; padding: 2px; text-align: center;">Dither Strength <span style="float: right; font-size: 0.8em;">AT</span></div> | <div style="border: 1px solid green; border-radius: 5px; padding: 2px; text-align: center; color: green; font-weight: bold;">150 mS</div> <div style="border: 1px solid green; border-radius: 5px; padding: 2px; text-align: center;">Fast Time OFF</div>  |
| <div style="border: 1px solid purple; border-radius: 5px; padding: 2px; text-align: center; color: purple; font-weight: bold;">Ramping</div> <div style="border: 1px solid purple; border-radius: 5px; padding: 2px; text-align: center; color: purple; font-weight: bold;">Test...</div>                            | <div style="border: 1px solid green; border-radius: 5px; padding: 2px; text-align: center; color: green; font-weight: bold;">700 mS</div> <div style="border: 1px solid green; border-radius: 5px; padding: 2px; text-align: center;">Cautious Time OFF</div>  |

← BACK →

**Nominal Speed:** This is the speed as a percentage that the vibrating trickler uses as its main speed setting and the center of the dithering speed.

**Idle Amount:** When the tube starts there is considerable inertia involved before the kernels respond to the vibration and begin moving. The pulse idle amount is set in units, which can be a value between Off (0) and 1 to 100, the default value is now 50 units.

Trial and error is the best way to deal with the setting. If the pulse time is taking a long time and flowing well, increase this value. If the powder seems to flow too much and you are getting many pulse overthrows, then reduce this value. Generally, reducing it in steps of 2 or 5 is common.

**Pulse Time ON:** Is the vibrating trickler running time in milliseconds. If ramping is used than the ramp will take place over this period.

**Pulse Time OFF:** Is the wait time in milliseconds that allows for the powder to fall to the cup and be measured by the scale.

**Fast Time OFF:** When the shortfall or remaining powder is of a considerable amount generally greater than 0.10 grains and with several other dependencies, the pulse may choose to use the Fast Time Off. These short delays between pulses has a very dramatic effect of moving powder fast, in an attempt to speed up the process of pulsing kernel by kernel. If you find that pulse is dragging at weights remaining greater than 0.10 then you may want to try reducing this value. Likewise, if the pulsing system is too energetic with the weights greater than 0.10, causing overthrows, then increase this value (it's not uncommon to have it near or the same as the standard off time).

**Cautious Time OFF:** When a kernel has been detected by the scales and the remaining powder is small the system will use this off time rather than the normal pulse off time. Allowing better inflight allowance and evaluation time. Generally 700 milliseconds is adequate for this job but some powder may need more if they are particularly resonant like extruded powders and maybe you can get away with less time other powders.

**Dither Strength:** Pressing this will give you range of dither strengths to choose from. Use dithering if you find the pulse is not moving the kernels in a timely manner.

**Enable Ramping:** (option) this will turn on the ramping operation to soften the pulses impact. Ramping will start the speed of at  $\sim 1/2$  of the nominal speed and then begin ramping to full speed over the pulse period.

**Test:** This will take you to a page that will allow you to test the pulse speeds. From this page you can run the motor and adjust the speed while observing the behaviour of the powder flow. The test screen also has the speed lock option to disable the AI self-learning from touching the motor speed.

## PULSE SETTINGS

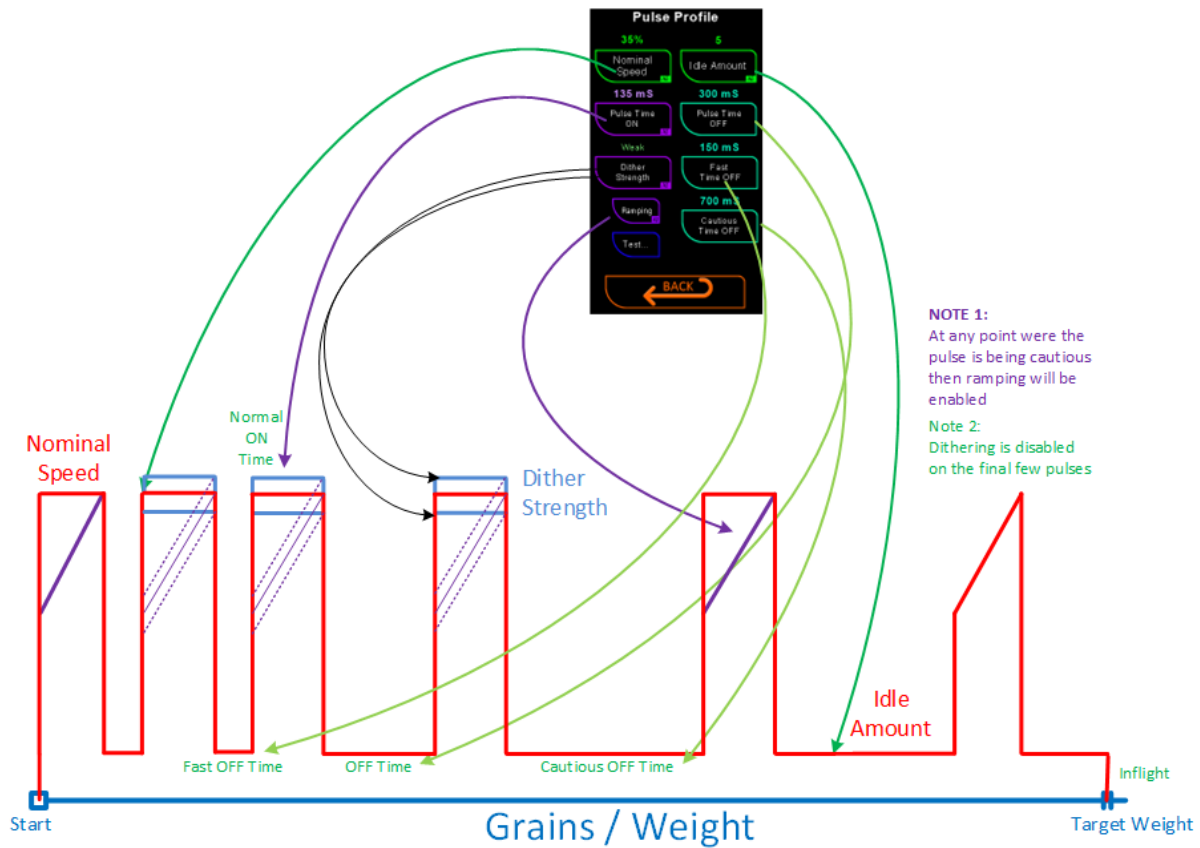

**Note:** It is feasible to have the pulse ON times very short with lighter powders. The vibrating trickler can operate with very quick consecutive pulses. The caveat for this type of operation is that the powder granule weight and inflight granules fall within the charge tolerance.

## AI Self-Learning Settings

The self-learning feature is designed to help quickly establish profile settings. While nothing can replace the operator's eyes, ears, and intuition for fine-tuning, the goal of self-learning is to get the settings to a good place for the operator to make necessary adjustments.

The self-learning system uses artificial intelligence to make reasonable changes to the settings, determined by overshoots and operational performance monitoring. Like humans, it uses a combination of errors, state, expectations, and neural triggers to decide if it should react and what changes to make. The system may adjust the profile even if the charge itself was successful, if it sees potential for better control parameters. It doesn't react to every error to avoid the system running slower over time. Given the nature of gunpowder flowing inconsistently, the AI attempts to balance speed and errors during this process.

Explaining the complexities of AI self-learning or the terminology is beyond the scope of this manual. It's easier to accept the parameters as a guide to self-learning, aiming to provide results close to what you seek. However, understanding the functionality of the instrument's heuristics is still essential.

### Gestalt's (down the rabbit hole)

Not unlike humans, the self-learning system can get it wrong—each learning iteration builds on previous changes and assumptions. A Gestalt is a psychological concept; something such as a structure or experience that, when considered as a whole, has qualities that are more than the sum of its parts. Humans can be influenced by a Gestalt (belief) that collectively works against them. Gambling is a good example of this: if someone wins the first time they gamble, a Gestalt is created, and they have a much higher chance of becoming a gambling addict. The same applies to AI. If the perfect storm occurs in the early stages of self-learning, it will build on these early experiences, potentially resulting in a poor outcome. You can always reset the profile (Restore default) and start again.

### AI Scholar Hat Icon

The Scholar hat will display in several different colors depending on the state of the AI system.

Hat Colors:

Yellow: The Entire profile does not exist yet or has just been reset, or any single instrument has just been reset.

Green: Unit in Full Learning mode. All instruments will show green as well.

Blue: Some instruments have stopped learning; those instruments will be blue as well.

Purple: All Self Learning is in monitoring mode (not changing anything) and may start again.

Note: there is no harm of the purple hat, it does not turn off however it is an indication the unit is not dispensing well.

Instrument Text Colors:

Green: Instrument Learning.

Bright Blue: Core learning stopped; slight tweaks may still take place.

Orange: Self Learning switched off.

## Heuristics

Heuristics is complex, however, in simple terms receptors build with success and degrade with failure. Their function in the SuperTrickler is to prevent the self-learning from over-reacting to every little powder glitch. Without heuristics, the self-learning would seek to make an adjustment to every single failure. It would end up never overshooting, but at the cost of speed - taking a long time to dispense every load so, the receptors look at both the successes and failures of an instrument, learning from them in order to prevent an error from overresponding. You could look at the heuristics as a failure tolerance level.

## Self-Learning Parameters

The self-learning uses seven parameters to determine the type of learning. The screen shows the setting values and (in gray) the current successive count and a summation of the neural receptors count (if used). The parameters are as follows...

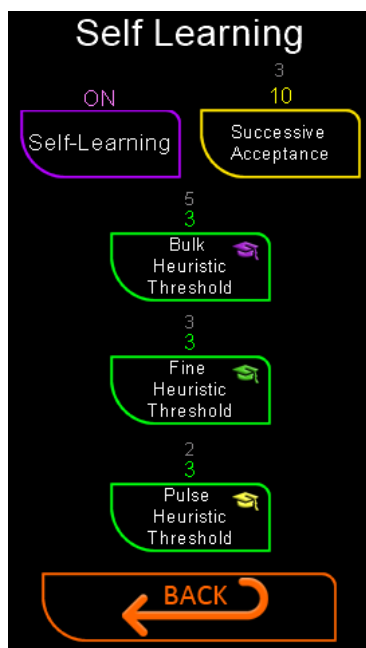

**Self-Learning:** Simply turns the self-learning on or off manually.

**Note:** When turning on the self-learning, all receptors will be reset and will require self-relearning.

**Successive Acceptance:** An automatic control that will turn off the self-learning after all the heuristics thresholds have been reached and the values successful charges in a row with no failed charges in-between and been reached.

A low value will force the self-learning to be disabled after few good rounds in a row. A large value tells the self-learning to keep working until many good rounds in a row have occurred, however it may not do much once the instrument's heuristic finds a happy place. If you want 100% success rate, set this value high along with the heuristic thresholds.

**Instrument Heuristics Threshold:** In some ways the heuristic threshold is like the successive acceptance. The successive acceptance is an overall function to disable the self-learning and is looking only at the number of successful charges in a row. The heuristic threshold is looking at individual instrument's 'neural receptors' that grow with success and degrade with failure and the threshold at which enough success has occurred to disable the self-learning for only that instrument. However, if that instrument (for whatever reason), starts to fail several times in a row, the self-learning will kick back in for that instrument. As an example, a value of three means three successes in a row by that instrument and learning stops for that instrument. However, if it succeeded three times then failed once, the instrument learning would start again. So how do we use this setting? If you desire speedy charges and are willing to forgo a few overshoots, set this value down to two or three. If you desire a 100% success rate, then set this value to a larger number. When seeking a good success rate, rather than set all the instruments to a high threshold, only set the instrument or instruments that are failing to a higher value, giving the occasional overshoot, and yet maintaining good charging speed.

## Profile Reset

There are many reasons why you may choose to reset the profile and start again. It is fair to say that we have all, at some time, made assumptions based on misinformation, leading to a cascade of bad decisions. The Artificial Intelligence is no different. If, at a critical point when the AI is taking a measurement, a clump of kernels falls, the AI will assume this is the characteristic of the powder in general. Conversely, if the powder is not flowing well while the AI is trying to measure the flow rate, the AI can quickly draw the wrong conclusion, and you can end up with a very poor profile setting, causing overthrows or slow performance. In such cases, it may be better to reset the profile and start again, or just reset the instrument you think is performing poorly.

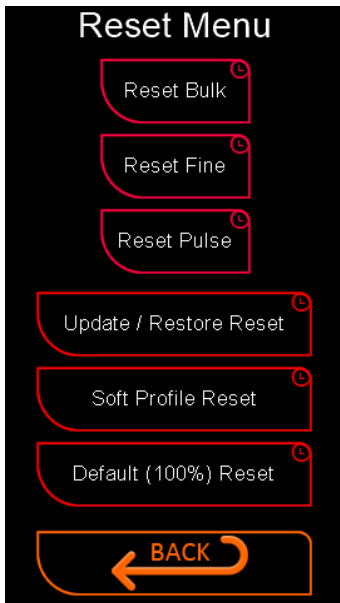

**Reset Bulk:** Resets just the Bulk Instruments part of the profile with the exception of the Bulk motor current

**Reset Fine:** Resets just the Fine Instruments part of the profile.

**Reset Pulse:** Resets just the Pulse Instruments part of the profile.

**Update / Restore:** re-reads the 'powder properties data', then restores all settings back to the factory defaults with the exception of the following.

- Setpoint
- Cartridge Volume (Presets)

**Soft Profile Reset:** Resets all the profile with the following exclusions...

- Final stabilization time
- Setpoint
- Tolerances
- Vibrator base setting
- Vibrator high speed limit
- Vibrator Off Mode
- Bulk motor current
- Cartridge Volume (Presets)
- Timeout

**Default (100%) Reset:** Resets every aspect of the profile back to the default setting with the only exceptions being the Charge Setpoint and Cartridge Volume (Presets).

## Powder Profile Summery

Initially, the powder profile system and configuration may be overwhelming and appear complex, but with a little experience, you will find that the system is not that difficult to understand. The self-learning will manage much of the system for you, and in fact it is not unusual to simply ignore the profile and let the AI manage it completely.

Power users will always want to modify or optimise the system to suit their own values. If it all goes pear-shaped, simply hit the reset and start again. At any time, you can set the inflight amounts back to zero and ensure the AI self-learning is running and let it fix the problem. In general, this is recommended after a speed change of any instrument.

The powder profile is a powerful tool, enabling great control of the system and yet can be ignored by the operator that prefers to sit back and let it do its own thing. We envisage in the future a series of Master Class videos that will give you the confidence to refine these setting to perfectly meet your needs.

User Notes...

## Powder Flow Graph

The powder flow graph can be found at the top the following screens: vibrator setting, motor flow test, bulk test, fine, test, slow test & pulse test.

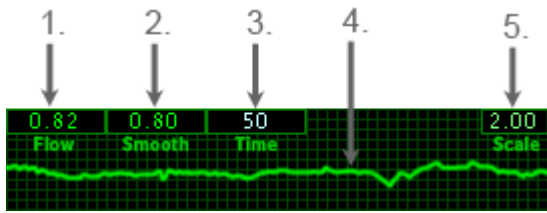

1. is the flow shown in grains.
2. is the filtered smooth flow.
3. is the time (seconds or milliseconds) in between flow data changes from the scale.
4. is the graph line showing the flow.
5. is the graph resolution scales (full scale deflection shown in grains). To change the scale resolution, simply touch anywhere of the graph and this will cycle through the available options.

## Charge Weight Drift Monitoring

For five seconds after the charge (drop) is finished, the system will monitor the weight for any change outside of the tolerance. In the event that the weight drifts outside the tolerance band the red work-light will begin flashing (the green-light will remain on) to indicate a drift was detected. From this point it's up to the operator to accept or reject the charge.

The drift only monitors for 5 seconds because outside of this time frame the most likely cause of drift is scale drift and this is no longer indicative of the actual weight. The common causes of drift are after the charge a few kernels have fallen in or most likely the Final Stabilization time is too short; this is especially likely with large kernels that have much resonance and take a longer time for the scale to obtain a stable reading.



## Micro SD Card



The SuperTrickler utilises a [Micro SD card](#) that has four core functions.

1. The first is to act as solid-state drive to hold the systems several databases.
2. The second functionality is to hold the .CSV log files containing the successful and failed charges.
3. The third is to store a record of the system settings for support analysis.
4. The fourth is for firmware updates.

**WARNING: The micro-SD card itself acts as an ingress barrier into the electronics and it is very important not to load or empty the powder hopper when the card is removed.**

### Card Type

The maximum card size that is supported is 32GB. When replacing the card, a high-quality SD card such as a Kingston or SanDisk, is highly recommended. A cheaper card may work reasonably well but may slow your system down considerably. Further to this, a cheaper card may not support the firmware upgrades, as this is very card quality dependent. The card must be fully SD Association compliant.

### Card Format.

It is critical that you use the SuperTrickler formatting function and not use a card formatted by a personal computer. Often personal computers do not format to the SD Association specifications. The card might work in general but may not support the firmware updates.

Please see the System – Peripherals – SD card, for details on how to initiate the card formatting function.

### Card Removal and Insertion.

To remove the SD card, press on the card then release, and the card will release to the upper position for removal with your fingers or tweezers.

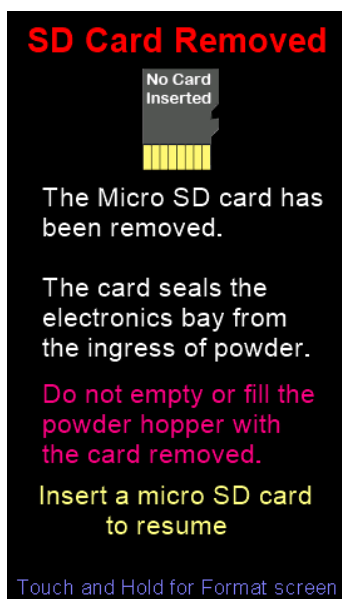

In most cases when the card is removed the SuperTrickler will display a warning screen (shown to the left) and will not function until the card is inserted.

To insert the card, place the card with the gold terminals facing the front of the machine, then gently insert it into the SD card slot. Once the card in the slot, press it down until it clicks into position.

**Warning:** Do not remove the card (or turn off the power) while a charge is taking place, unless the display is showing IDLE, or while a firmware upgrade is in progress or while formatting an SD card. The removal of the card or loss of power during a firmware update may permanently damage your SuperTrickler.

**Note:** If for some reason your will card cannot be detected, the cause maybe an incompatible or defective card format, touching anywhere on the screen for a few seconds will take you to the SD card screen enabling you to try reformatting the card (all card data will be lost).

## Interface Ports

Located on the rear of the SuperTrickler.

**Warning:** These connections are for the use with only SuperTrickler equipment or approved third party equipment. Any other use or connection may permanently damage the SuperTrickler and is not covered under Warranty.

### Expansion Port Female DB25

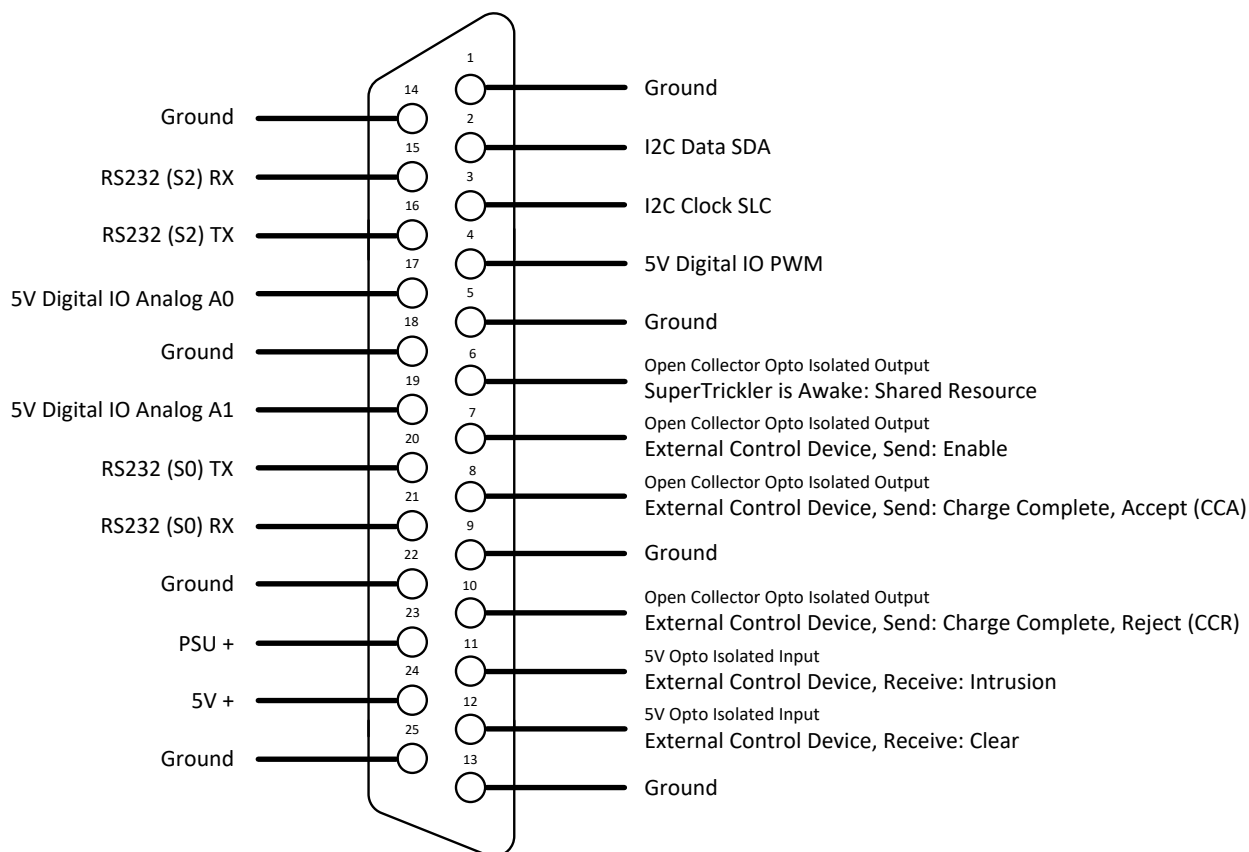

### A&D Scales Port Female DB9

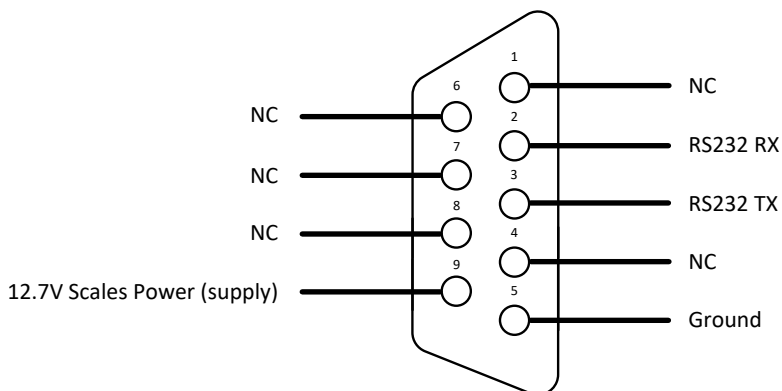

## Specifications

| <b>SuperTrickler standalone unit</b>               |                                    |  |
|--|------------------------------------|--|
| Empty Weight                                       | 1230 grams                         |  |
| Height   | 265 mm (10.1")                     |  |
| Width  | 183 mm (7.2")                      |  |
| Depth  | 183 mm (7.2")                      |  |
| Hopper volume (total)                              | 725 grams of water                 | 725CC (44.24 cubic inches)                       |
| Unusable Hopper volume                             | 40 grams of water                  | 40CC (2.44 cubic inches)                         |
| Scale Compatibility                                | A&D FZ/FX Series Precision Balance | With RS232 serial interface                      |
| Scale Weight Range Limit                           | -327.00 to 327.00 grains           | Independent of attached scales                   |
| Scale Data Stream Weight Type                      | Grains or Grams                    |  |
| Accuracy   | 0.02 grains                        |  |
| Tolerance range                                    | 0.10 – 0.02 grains                 |  |
| Compliance approvals                               | CE, EMC                            | With scale connected                             |
| <b>SuperTrickler seated on A&amp;D FZ/FX scale</b> |                                    |  |
| Empty Weight                                       | 3760 grams                         | With the scale pan, powder cup and serial cable. |
| Height   | 336 mm (13.2")                     |  |
| Width  | 187 mm (7.4")                      |  |
| Depth  | 260 mm (10.2")                     |  |
| <b>Power Supply Unit (PSU)</b>                     |                                    |  |
| Type   | AC to DC                           |  |
| Format   | Wall Socket Mount                  |  |
| Input Voltage                                      | Range 80 – 264V                    | Nominal 110/230V                                 |
| Plug Type  | AUS, EU, UK, US                    |  |
| Compliance approvals                               | CE, UL                             |  |
| Output Voltage                                     | 15V                                |  |
| Output Current                                     | 4.0A                               |  |
| Weight   | 200 grams                          |  |
| Height   | 56.2 mm (2.21")                    |  |
| Width  | 39.1 mm (1.54")                    |  |
| <b>Power</b>                                       |                                    |  |
| Max  | 33.5W                              | Rotating motor shaft locked                      |
| Typical During Charge                              | ~16W                               | Rotating motor at 2000 mA                        |
| Idle   | 6.5W                               | White work light on                              |
| Idle   | 6.1W                               | White work light off                             |
| Sleep  | 4.7W                               | Scale remains in sleep                           |
| Powder Down  | 1.4W                               | Via SuperTrickler control                        |
| <b>Powder Cup</b>                                  |                                    |  |
| Volume   | 25.9 grams of water                | 25.9CC (1.58 cubic inches)                       |
| Empty Cup Weight                                   | 43.9 grams                         | Standard Cup                                     |

## **Support**

Before contacting us, please refer to the [common problems](#) section at the end.

If you require additional help, you can contact our support team at [support@supertrickler.com.au](mailto:support@supertrickler.com.au), though please allow several days for a response as the support desk is not manned fulltime. A member of the support team may request you to email one or more files held on the Micro SD card to assist in the resolution of the problem.

## **Feedback**

The SuperTrickler was designed and developed on the concept of giving reloaders what they are asking for. We have always welcomed feedback from our followers and will extend that to our users. Not every idea is feasible however, when possible, with a great idea or with enough people asking for a change, we will endeavour to implement changes to refine the SuperTrickler moving forward. We maintain a list of future plans, ideas, and thoughts. Some of these have already been flagged for near future firmware releases that time has not permitted us to reveal in the first firmware version. The progression from idea to practical application and impact considerations is often a slow process and so it should be. The change benefit and potential negative impact, along with costs must be considered with every idea, but without ideas and an understanding of what our users want from the SuperTrickler, the product becomes a stagnate product like many similar products on the market. This is not what we want and therefore invite you to share your feedback and ideas with us by email at [feedback@supertrickler.com.au](mailto:feedback@supertrickler.com.au)

## Appendix A: Upgrade/Firmware Naming Conventions

The firmware file names follow the naming convention listed below:

Prior to Version V1.00 to and including 2.00 only

Examples: SOC2-0N2-0T1.stf : SOC1-4N.stf : SOC1-5N Patch 6.stf

**\*bold is not optional**

**S = Serial Number.**

# - serial number, 0 = all machines.

**C = Controller Board Firmware Version.**

# - Major Version.

- dash

# - Minor Version.

**N = User Interface (HMI), N dictated the TFT brand name.**

# - Major Version.

- dash

# - Minor Version.

T = TFT (user interface) type

# - Type number

[space]

Patch

# - number

.stf

Linear layout: Serial #, Firmware Version, [UI Version & Type ], [patch]

From Version V2.10 to V3.1.0

Naming convention changed for clarity and better content information.

Example: V2-10T1U2-10T1-X.stf : V2-20T1-X.stf : V2-10T1 Build 2.stf : V2-20T1-S122090203.stf

**\*bold is not optional**

**V = Firmware Version**

# - Major Version.

- dash

# - Minor Version.

**T = Controller Board Type.**

# - Type number.

U = User Interface (HMI).

# - Major Version.

- dash.

# - Minor Version.

T = User Interface Type.

# - type number.

-X dash X indicates the stf file is carrying an undefined extra file.

-S dash S, the file has been built for specified machine.

# serial number.

Linear layout: Firmware Version & Type, [UI Version & Type ], [extra file], [Serial #], [build]

### From Version V3.2 onwards

Naming convention changed for clarity and the upgraded packaging ability.

Example: V2-10T1U2-10T1-X.stf : V2-20T1-X.stf : V2-10T1 Build 2.stf : V2-20T1-S122090203.stf

**\*bold is not optional**

**V = Firmware Version**

**# - Major Version.**

**. dot**

**# - Minor Version.**

**. dot**

**# - Build.**

**T = Controller Board Type.**

**# - Type number.**

U = User Interface (HMI).

# - Major Version.

. dot.

# - Minor Version.

T = User Interface Type.

# - type number.

- dash

X dash X indicates the stf file is carrying an undefined extra file.

P the file contains the powder.dbl file

F the file contains the proforma file.

-S dash S, the file has been built for specified machine.

# serial number.

Linear layout: Firmware Version & Type, [UI Version & Type ], [extra files], [Serial #]

## Appendix B: Common Problems

| Problem  | Fix   |
|--|---|
| <i>Dispensing</i>  |   |
| Rotating tube stops or has stopped turning or is making a clunking sound.                      | <ol style="list-style-type: none"> <li>1. Empty the hopper then remove the tube and clean the motor drive and the back of the tube as well as the motor shaft and opening. You can use a small paint brush or gentle compressed air.</li> <li>2. Increase the bulk motor current in the bulk profile settings.</li> </ol>   |
| Vibrator tube does not seem to be working as well as it has been or is not delivering powders. | <ol style="list-style-type: none"> <li>1. <b>Gently</b> pull on the tube to ensure it is all the way out, WITHOUT ROTATING THE TUBE.</li> <li>2. Make sure there is sufficient powder in the hopper.</li> <li>3. If it stutters or stops running, try increasing the start time in the deep settings.</li> </ol>  |
| The AI is not learning well.   | <ol style="list-style-type: none"> <li>1. Check your vibrator speed settings</li> <li>2. Reset the profile or the instrument that is not performing well and let the AI learn again.</li> </ol>   |
| The AI will not turn off with the purple scholar's hat displayed.                              | The AI is in monitor mode, it knows the profile is not running the best but cannot pinpoint the problem. There is no harm in letting it run or you can turn it off manually in the profile under self-learning.   |
| Low Success  | <ol style="list-style-type: none"> <li>1. If the bulk overthrows a lot, try reducing the speed to 90-95% in the profile settings.</li> <li>2. Check your vibratory tube speed settings as stated above in the AI not learning section</li> <li>3. Check for adequate amount of powder in hopper.</li> <li>4. Turn the profile more 'vibrator off mode' to Stop</li> <li>5. Change the Vibrator Base Speed Offset</li> </ol> |
| <i>Upgrade</i>   |   |
| Error during an upgrade or the process just froze.   | Download the upgrade stf file again and try another installation (do not format the SD card).   |
| If the power goes off during an upgrade.   | Contact support. <a href="mailto:support@supertrickler.com.au">support@supertrickler.com.au</a>   |
| <i>Setup</i>   |   |
| Scales will not read.  | <ol style="list-style-type: none"> <li>1. Make sure the cable is completely plugged in.</li> </ol>  |

|   |   |
|---|---|
|   | <p>2. The scales need to be setup; ensure you have setup the scales as per the instructions in the SuperTrickler users manual. .</p> <p>3. Double check the scale program settings going through the scale menus. Checking that ALL settings are correct including the ones marked with a red highlight.</p>  |
| I still cannot get the scales to read.      | As per the instructions, do a factory restore of the scale settings. Then start again setting up the scales, ensure all settings are as prescribed correct including the ones marked with a red highlight.  |
| <i>Misc</i>                                 |   |
| I formatted my SD card and lost everything. | <p>Formatting should not normally be required for any part of the SuperTricklers operation including updating.</p> <p>The SuperTrickler will automatically recreate critical files however you must download the powder.dbl file and proforma file (profile.pf) to suit your version from the ancillary file section of the web site:<br/> <a href="https://supertrickler.com.au/powder-database/">https://supertrickler.com.au/powder-database/</a><br/> Place the files on the root (top folder) of the SD card then reinsert the card.</p> |
| My powder.dbl file is missing               | <ol style="list-style-type: none"> <li>1. Download the powder.dbl file from the ancillary file section of the web site:<br/> <a href="https://supertrickler.com.au/powder-database/">https://supertrickler.com.au/powder-database/</a><br/> Place the file on the root (top folder) of the SD card then reinsert the card.</li> <li>2. Check the file is called “powder.dbl” and not some other name like “powder (1).dbl”</li> </ol>   |
| 1202 Database Error                         | In earlier versions, an unresolved issue existed where, in the event of a timing issue with the SD card database, the system would issue a 1202 error and disable the database to protect it from damage. In later versions, this has been resolved. If this error persists, you will need to contact support with the FIRMWARE VERSION you are currently running. They will send you a file to place on the SD card that will correct the error.   |



User Notes...