

# SuperTrickler

When True Precision Matters



**ST101 Owner's Manual**

# Important Safety Instruction

Thank you for purchasing your Petersen Kowald SuperTrickler ST101 smokeless gunpowder dispensing unit. We want you to get the best out of this easy to use and feature rich unit. Taking a small amount of time to read this manual will greatly benefit you in getting the SuperTrickler working for you and getting the most from its benefits and functionality.

The manual contains important safety, installation and operating instructions for the SuperTrickler and compatible A&D balance (scale). Do not operate the SuperTrickler or balance unless you have read and understood the specifics of the instructions.

Petersen Kowald is a collaboration between Rex Petersen & Peter Kowald for the development and support of the SuperTrickler, with the manufacturing and sales from Modgunn Security ApS (Denmark).

## **Disclaimer**

Gunpowder is a dangerous material and before using this equipment and before reloading, we recommend that you seek expert advice on the proper use of all products, handling, procedures and charge quantities. Rex Petersen, Peter Kowald, SuperTrickler & Modgunn Security ApS take no responsibility for any harm or damage that may result from use of the SuperTrickler and the reloading process.

## **General Safety**

Failure to adhere to the following safety rules can result in property damage and/or serious personal injury. Read and understand the safety rules before attempting to reload ammunition.

Only reload ammunition when you can give your full and undivided attention. Avoid distractions such as television, visitors, or any other factors that may adversely affect your concentration.

NEVER attempt to reload while under the influence of alcohol, drugs or medications that may affect concentration or judgment.

Thoroughly read and understand all reloading equipment instructions before using that equipment. If you do not understand the written instructions, contact the manufacturer of the piece of equipment for clarification before proceeding.

Wear approved safety glasses during all reloading operations and make safety glasses available to any approved visitors to your loading area.

Make certain that all equipment is appropriately anchored to, or placed on, a solid work surface during use. Follow the tools manufacturer's instructions for safely mounting of all equipment.

Observe good housekeeping in the reloading area. Clean up spills promptly and limit the components on the bench to only those required for the immediate task at hand.

Keep accurate and legible records; the SuperTrickler can log and track powder batches, however, it is up to the operator to ensure the correct information is entered into the system. Label everything so there is no confusion regarding the ammunition or components.

Store and keep powder and primers away from sources of heat, open flame and out of the reach of children and follow your country's legal requirements for storage.

Do not smoke, eat or drink in the loading area.

Keep powder and primers in their original, factory-marked containers. Discard any components that lose their identification information. If you must remove any components from their factory containers during loading, return them to their proper containers as soon as the dispensing session ends to prevent the ingress of moisture or other contaminants.

Keep no more than one container of propellant on the bench at a time. Store other powders away from the bench to avoid mistakes or mixing.

Carefully read and follow published reloading data. Verify that your loading manual is open to the correct page for the cartridge you are loading.

The SuperTrickler is designed exclusively for the FZ/FX series of balances (scale); never attempt to use the SuperTrickler with any unapproved brands or models. The balance must be warmed up for at least the manufacturer's recommended period of time and calibrated before reloading commences.

Keep the balance (scale) clean and remove the powder cup, dust & debris before calibration.

Calibration weights must be accurate and clean. It is recommended that the weights are never touched with bare hands and the use of thin cotton gloves, or a lifting tool, should be used.

The balance is a sensitive piece of equipment and care must be taken not to drop the unit or drop anything onto the unit. In the event that the unit has been (or has potentially been) damaged, it must be returned to the manufacturer or approved repairer.

Avoid locating balance within three feet (one meter) of fluorescent lights. The electromagnetic fields generated by such lights can cause weighing errors.

Never use damaged equipment, contaminated, or damaged products for the reloading process.

It is not recommended to have transmitting equipment such as cell phones or other strong transmitters near your reloading equipment. This type of equipment can interfere with the data communications between the scale and the SuperTrickler and may also interfere with the scale operation and calibration.

Cell phones and other devices with batteries are a fire risk and it is not recommended to have such devices present in the vicinity of gunpowder.

The SuperTrickler is equipped with a touchscreen display; the screen is designed to be operated with your finger or soft blunt pointer only. Do not use a hard or sharp object to operate the touchscreen.

## **Warning**

**DO NOT USE WITH BLACK POWDER:** This equipment is designed and approved for smokeless gunpowder only.

**Do not remove the bulk trickler tube with powder in the hopper.** Doing so will allow powder into the body of the unit and will require cleaning from an authorised service center, at your cost.

**Micro SD Card:** The unit must not be used, filled, or emptied without the Micro SD card installed, as the location of the card prevents the ingress of material into the electronics bay.

**Do not use an unapproved Power Supply Unit.** The power supply unit supplied with the A&D precision balance **MUST NOT BE USED**, on either the SuperTrickler or the balance unit, while the SuperTrickler is connected. The precision balance obtains its electrical power from the SuperTrickler and must not be used in conjunction with any other power source. The SuperTrickler is supplied with a very high-quality medical grade power supply unit. This is the only approved power supply. Spare units are available from SuperTrickler if required. The use of another power supply may damage the SuperTrickler and or the A&D precision balance and will void the warranty of either, or both units.

## **Scales/Balance**

Scales and balances are both weighing machines. They are different in that a scale measures weight while a balance measures mass. Weight is the force of gravity on an object and a balance compares the mass of two different objects. The term 'scale' or 'scales' historically has been used in reloading to describe the weighing device and as such will be used throughout this document.

## **General Terminology**

Scale: The A&D FZ/FX series balance.

Weight: The amount of powder as weighed by the scale.

Powder: refers to smokeless gunpowder.

Load and Charge: refers to powder dispensed for the purposes of loading a bullet.

AI: is the acronym for Artificial Intelligence.

SD card: refers to the Micro SD Card.

## **This Document**

This document was specifically written for the SuperTrickler ST101 firmware version 1.04, SuperTrickler & Modgunn Security ApS, maintain the right to change this document and or the firmware at any time without notification.

This manual should be read and understood before operating the SuperTrickler. If you have questions, or are having difficulty understanding any of this documentation, please contact our support desk:

[support@supertrickler.com.au](mailto:support@supertrickler.com.au)

To find the latest version of this document please download from:

<https://supertrickler.com.au/documentation>

# Table of Contents

---

## Table of Contents

General .....	8
Introduction.....	8
Key Components .....	9
Front .....	9
Top.....	10
Bottom.....	10
Rear.....	11
Installation.....	11
Scale.....	11
SuperTrickler .....	12
Programming the Scale .....	14
Testing the communications .....	20
Level & Calibrate the scale .....	21
Setting the clock .....	21
Filling and Emptying the Gunpowder Hopper.....	22
Filling.....	22
Emptying.....	22
Quick Start – let’s have some fun.....	23
The trade-off between speed and failures.....	25
Micro SD Card.....	26
Card Type.....	26
Card Format.....	26
Card Removal and Insertion.....	26
Menu System.....	27
Special Buttons. There are two types of special buttons that you find throughout the system.....	28
Hold to activate .....	28
Quick Return.....	28
Main Sub Menu .....	28
Soft keypads .....	29
Numeric Keypad .....	29
Alphanumeric Keypad .....	30

Dispensing .....	30
From the Main Menu .....	30
Dispensing Screen.....	31
Charge Setpoint.....	31
Selecting a Powder or Pre-set .....	32
Powder & Pre-set Profile Database.....	32
Selecting a Powder .....	32
Pre-set Charge Profile Database .....	33
Selecting a Preset profile.....	34
Modes.....	35
Operational.....	37
Tools & Settings Menu .....	37
Options & More.....	37
Options .....	38
Data Logging Option.....	39
Motors .....	40
Change Bulk Tube .....	40
Motor Testing .....	41
Calibrate Scales.....	41
Scale Calibration Weight .....	42
Automatic power up times.....	42
System .....	43
System Menu.....	43
Peripherals.....	43
SD Card .....	44
Scales (Balance) .....	45
Powder Cup Scales Monitoring .....	45
Powder Cup Laser Sensor .....	46
Date & Time.....	47
Expansion Port.....	47
Setup Menu .....	48
Restore .....	48
Core Menu.....	49
Firmware Update.....	50
Update Error codes .....	51

Charge Log Files .....	52
Log File Backup .....	53
Powder Profile .....	53
Control System Philosophy .....	54
Vibrator Speed Settings .....	55
Instruments .....	55
Profile Variables .....	56
Bulk Instrument .....	58
Process of the Bulk Instrument. ....	58
Bulk Instrument Parameters .....	58
Fine Instrument .....	59
Process of the Fine Instrument. ....	60
Fine Instrument Parameters .....	60
Slow Instrument .....	61
Process of the Slow Instrument. ....	61
Slow Instrument Parameters.....	61
Pulse Instrument .....	62
Process of the Pulse Instrument. ....	62
Pulse Instrument Parameters.....	62
AI Self-Learning Settings.....	63
Neurology .....	63
Self-Learning Parameters .....	63
Powder Profile Summery.....	64
Interface Ports .....	65
Specifications.....	66
Support .....	67
Feedback.....	67

## General

### Introduction

The SuperTrickler is the most advanced and unique gunpowder dispenser available on the market, at the time of release, and here is why:

It has taken almost three years to develop this highly sophisticated, easy to use, fast, highly accurate, and feature-rich dispenser that is designed for both new and experienced home users.

It uses an external laboratory balance from A&D, with an accuracy of 0.02 grains. Delivery from its generous hopper is from a two-tube system; a rotating tube for the fast bulk delivery and the final touches are carried out with a fine vibrating tube. The result is a very quiet, fast, and precise charge that saves valuable time and ensures you do not need to worry about the precision.

The SuperTrickler employs Artificial Intelligence (AI) to assist in the process, with self-learning, proactive process monitoring, operation analysis and dynamic operation (the SuperTrickler does not use a fixed control sequence like other many other units on the market). The system also allows the operator to easily trim the system and make operational decisions that suit their preferences.

The SuperTrickler has many unique features to reduce mishaps – such as a laser that detects the cup is in position before starting a charge (currently experimental) and has a fast and clear standalone color touch screen interface that is intuitive to use, along with an extensive database with many known powder types (easily updated or personalised). This includes powder use tracking and reporting for those countries that require this information to meet their legal obligations.

The data logging feature is extensive, with several separate log files that can easily be read and edited with any spreadsheet program. The log files include successful charges with all powder and tolerance details, un-successful charges, including extensive detail on how the charge process was carried out by the AI engine, powder profile details and the root cause of the error. This feature makes it easy for remote support should you encounter an ongoing problem. To further enhance remote support there are several other log files that record settings and additional information. This will greatly assist the ability for the support personnel to identify and resolve any issues quickly and efficiently. This system also includes the ability to select a date format to suit your country.

Some of the many other features are:

- Easy automatic laddering.
- Unlimited pre-set charges for all your common loads.
- Self-learning feature can easily be controlled or turned off to suit your own preference of speed and success.
- Automatic turn on and warm up timers (have your trickler ready for when you are)
- Soft buttons and/or timers to initiate sleep or power down.
- Sectionalised factory restore in case you find yourself with undesired results, or just want to play with the system.



- Easy A&D balance calibration; the SuperTrickler takes this functionality and gives the user an easy interface to calibrate the balance. This can be selected to be called every time you start your unit after the warm-up time.
- Easy firmware updates that are intensively verified to ensure updates go smoothly and effortlessly. This includes rollbacks.
- All successful and failed charges are supported with a colored light display and tone sequence to ensure the operator is aware of a failed charge (optional).
- Customizable tones to aid anyone with a hearing deficiency to hear the tones easily, with the option to disable them for silent operation.
- The most unique feature of all is the extensive and future proofing expansion port that allows for robotic interfacing and operational control, label printers, temperature/humidity monitoring and other devices with I2C and serial interfacing.

## Key Components

### Front



**Important Warning:** The vibrating trickler tube is a delicate component and must not be pushed, pulled or flexed. Doing so can destroy the tube and is not covered under warranty.

## Top

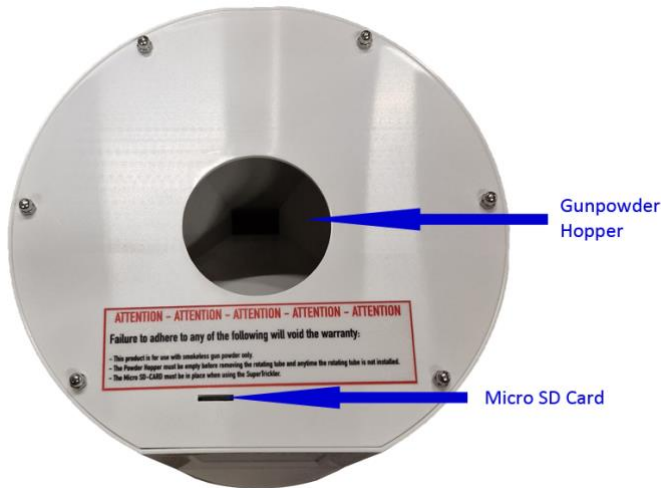

**Note 1:** It is normal that the inside of the Gunpowder hopper will discolor over time.

**Note 2:** The hopper does not have a cover; this is intentional as the SuperTrickler is not a storage container. Gunpowder is hydroscopic and can absorb moisture if not stored properly; for safety reasons, the powder should **always** be stored in its original container.

**Note 3:** Do not pour gunpowder into the hopper without the Micro SD card installed. The card acts as a seal to the electronics bay and doing so will void your warranty. In the event that you accidentally spill powder into the electronics bay, do not operate the SuperTrickler and contact [support@supertrickler.com.au](mailto:support@supertrickler.com.au) for advice.

## Bottom

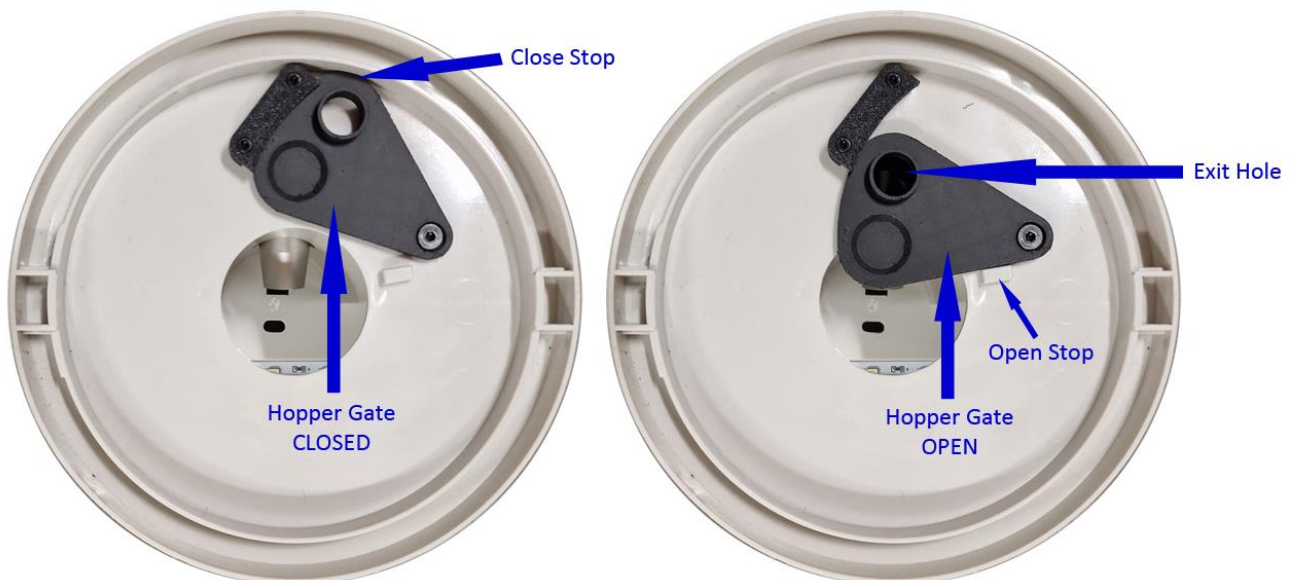

The SuperTrickler will not seat into position on the scale if the hopper gate is not fully closed, to prevent accidental spillage of powder.

**Warning:** Do not force SuperTrickler onto the scale. If the hopper gate is not fully closed, you may damage your scale.

## Rear

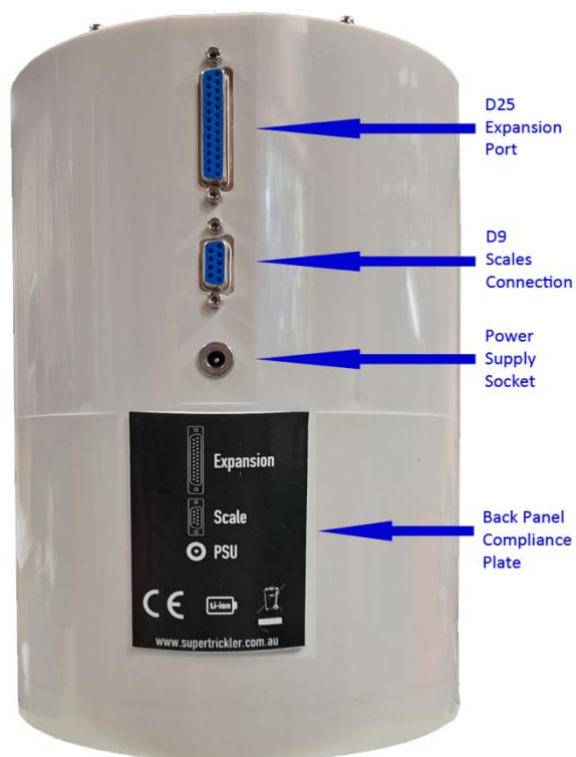

## Installation

### Scale

The scale is a precision instrument. Unpack it carefully. It is recommended to keep the packaging materials. **DO NOT** set it up, as per the A&D FX/FZ series owner's manual, as the SuperTrickler requires a different arrangement.

The following standard A&D balance components are **NOT** required for use with the SuperTrickler;

- Wind shield
- Scale plate and top plate
- The power supply once the SuperTrickler is attached (The SuperTrickler will supply power to the scale via the 9-pin cable).

Only the main scale unit is required for use with the SuperTrickler.

Please heed any precautions specified in the A&D owner's manual.

[https://weighing.andonline.com/sites/default/files/documents/FX\\_FZ-i\\_Instruction%20Manual.pdf](https://weighing.andonline.com/sites/default/files/documents/FX_FZ-i_Instruction%20Manual.pdf)

## SuperTrickler

Unpack the SuperTrickler carefully, it is recommended to keep the packaging materials.

1. Carefully install the SuperTrickler's custom scale plate into the scale plate slot, taking care not to press it in too hard (your scale is an expensive and delicate instrument).



2. Place the SuperTrickler's main body onto the scale, locating it such that it sits flat on the scale (note the locating slots to the left and right of the scale).



3. Plug the 9-pin cable into both the SuperTrickler and the scale; finger-tighten all the locking screws firmly. This is the communications & scale power source – if the scale standard power supply is attached, please remove it.

4. Plug the SuperTrickler's power supply unit in and turn it on. This will power up the SuperTrickler and power up the scale in warm up mode.

5. By default the SuperTrickler will start up with the scale in warm up mode. However, so that we can program the scale, we must first bypass the warmup timer and turn the scale on fully via the SuperTrickler.

6. When the SuperTrickler is first powered up, it will display a splash screen showing the firmware version number for a few seconds. It will then display the warm-up screen, giving instructions to ensure the scale plate is clean and clear.



7. Touch anywhere on the Clean & Clear screen to take you to the Main Menu.

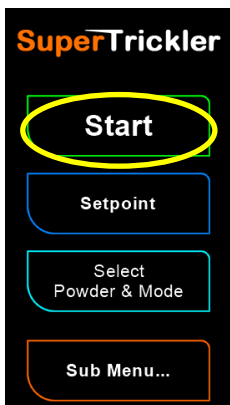

8. Touch the Start button to take you to the charging screen.

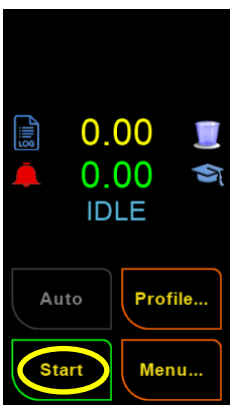

9. Touch the Start button to override the warmup timer.

10. Once the warmup timer has been overridden, the scale may be fully turned on and ready for programming. If the scale is not on, then press the ON-OFF button on the scale to turn on the scale.

11. The correct configuration is critical for communications and optimisation of the data exchange between the SuperTrickler and the scale. If your scales were supplied with your SuperTrickler, it will

be pre-programmed, and you can skip the follow section and continue at 'Testing the communications'.

11. Should your scale display an error **-E** then continue else you can skip down to 'Programming the Scale' section below.

12. The error is due to a considerable weight difference between the standard plate and the one used by the SuperTrickler and there for we must recalibrate the scale before we can program the scale. You will need a 100 gram precision standard weight for this process.

13. On the scale, press the  button for 2 seconds and the display should read **cal 0** after you remove your fingers.

14. Press  to set the zero and the display should change to **100**

15. Place a 100 gram weight on the new SuperTrickler plate

16. Press  and wait for the display to read **end**

17. Remove the 100 gram weight and the scale should display **0.000**

### Programming the Scale

This once off procedure is required to configure your precision balance to communicate with the SuperTrickler and to operate in the most practical way for precision charge loading.







If the scale programming is factory standard, then work your way through the following steps, if your scale has a nonstandard configuration to suit another device, refer to the 'Scale Table of Changes' below to compare and change your configuration. You may also perform a full factory reset on your scale's settings. Refer to the section below or your scales manual, section 9.2 titled 'Initializing the Balance'.

**Please note: The following is a guide only, as from time-to-time A&D may make firmware changes resulting in slight changes to the menus and parameters. See the table further down for all the correct settings that need to be modified. The procedure is the same, stepping through each section of the menus.**





### Scale Factory Reset

You MAY choose to do this to get your scale back to a known state. It will reset ALL settings.















To perform a factory reset: YOUR SCALE SHOULD BE OFF TO START THIS PROCEDURE

Steps	Button	Instruction	Display	Information
1	On/OFF	To turn the scale OFF		Display off, just the little arrow in lower left
2	 	Press <b>BOTH and HOLD</b>		While holding, go to next step
3	ON/OFF	Press ON/OFF	PS	Scale displays PS
4		Press <b>SAMPLE</b>	CLr	Scale displays CLr
5		Press <b>PRINT</b>	CLr no	To cancel, press <b>CAL</b>
6		Press <b>RE-ZERO</b>	CLr Go	Changes to Go/Yes
7		Press <b>PRINT</b>	End	Scale reset!













### Programming Buttons

	To enter the configuration menu, press and hold for 2 seconds. This button is also used to scroll between classes (areas) and item parameters.
	Changes the parameters (setting).
	When a class is displayed, moves to an item in the class. When an item is displayed, store the new parameter and display the next class.
	Exits the configuration mode.





**Note:** When pressing the step through button (SAMPLE or RE-ZERO) if the display is not shown as per the readout information press repeatedly until it does.

Steps	Button	Instruction	Display	Information
1		Press <b>SAMPLE</b> for 2 seconds (applies to make any changes)	<b>bA5Fnc</b>	Enter configuration menu Base Function
2		Press <b>PRINT</b>	<b>Cond</b>	Enter the class Condition is the first option
3		Press <b>RE-ZERO</b> 2 times	<b>0</b>	0 = Fast response
3		Press <b>SAMPLE</b> 4 times	<b>5Pd</b>	Display refresh rate
4		Press <b>RE-ZERO</b> 2 times	<b>2</b>	2 = 20 time/second
5		Press <b>PRINT</b>		Save & enter next class
6		Press <b>SAMPLE</b> 3 times	<b>dout</b>	Data output
7		Press <b>PRINT</b>		Enter the class
8		Press <b>RE-ZERO</b> 3 times	<b>3</b>	3 = Stream mode
9		Press <b>PRINT</b>	<b>END/5iF</b>	Save & enter next class (Flashes End, then SiF)
10		Press <b>PRINT</b>	<b>bP5</b>	Baud Rate
11		Press <b>RE-ZERO</b> 3 times	<b>5</b>	5 = 19.2 (19200 baud rate)
12		Press <b>SAMPLE</b>	<b>btPr</b>	Data Bits Parity Bit
13		<i>If this is not zero, press <b>RE-ZERO</b> until it is 0.</i>	<b>0</b>	7 Bits, Even (default)



14		Press <b>SAMPLE</b>	Crlf	Terminator (serial string)
15			1	1 = CR Carriage Return only
16		Press <b>SAMPLE</b>	tYPE	Serial data format type
17		Press <b>RE-ZERO</b> 4 times	4	4 = NU (number format)
18		Press <b>PRINT</b>		Save & enter next class
19		Press <b>SAMPLE</b>	Alt	Skips over this section
20		Press <b>PRINT</b>	Vnit	Units
21		Press <b>SAMPLE</b> 10 times or until GN appears	GN	Grains
22		Press <b>RE-ZERO</b>		Save as primary units
23		Press <b>SAMPLE</b> 2 times or until g appears	g	Grams
24		Press <b>RE-ZERO</b>		Save as secondary units
25		Press <b>PRINT</b> (applies to any changes)		Save & enter next class
26		Press <b>CAL</b> (applies to any changes)		Edit the configuration

To set the scale for a 50 gram precision standard weight.

Steps	Button	Instruction	Display	Information
1		Press <b>Cal</b> for 2 seconds	cal 0	Calibration
2		Press <b>SAMPLE</b>	100.000	100 gram weight
3		Press <b>Mode</b>	50.000	100 gram weight
4		Press <b>PRINT</b>	cal 0	Save change
5		Press <b>Cal</b>		Exit calibration change

### Scale Table of Changes

The following table shows the changes to the standard configuration. If you are unsure of the settings or should your scale have a nonstandard configuration to suit another device, please check the settings against this table. Check that all settings are as per the settings marked in yellow and unmarked settings are the factory defaults.

$CP_{Hi}$ Upper limit				
$CP_{Lo}$ Lower limit				
<i>dout</i> Data output	<i>Prnt</i> Data output mode	0	Key mode	Accepts the <b>PRINT</b> key only when the display is stable.
		1	Auto print mode A (Reference = zero)	Outputs data when the display is stable and conditions of $RP-P$ , $RP-b$ and the reference value are met.
		2	Auto print mode B (Reference = last stable value)	Outputs data continuously.
		3	Stream mode	Accepts the <b>PRINT</b> key regardless of the display condition.
		4	Key mode B (Immediately)	Accepts the <b>PRINT</b> key immediately when the display is stable, or waits for the display to be stable when not.
		5	Key mode C (When stable)	Uses interval output mode.
		6	Interval output mode	
	$RP-P$ Auto print polarity	0	Plus only	Displayed value > Reference
		1	Minus only	Displayed value < Reference
		2	Both	Regardless of displayed value
	$RP-b$ Auto print difference	0	10 digits	Difference between reference value and displayed value
		1	100 digits	
		2	1000 digits	
	<i>int</i> Interval time	0	Every measurement	Interval time for the interval output mode (With $Prnt$ 6)
		1	2 seconds	
		2	5 seconds	
		3	10 seconds	
		4	30 seconds	
		5	1 minute	
		6	2 minute	
		7	5 minute	
	$S-ID$ ID number output	0	No output	Selects whether or not the ID number is output.
		1	Output	
	$S-t d^*$ Time/Date output	0	No output	
		1	Time only	
		2	Date only	
	$PUSE$ Data output pause	0	No pause	Selects the data output interval.
		1	Pause (1.6 seconds)	
	$RL-F$ Auto feed	0	Not used	Selects whether or not automatic feed is performed.
		1	Used	
	<i>info</i> GLP output	0	No output	Selects GLP output method.
		1	AD-8121 format	
		2	General data format (output time and date using the built-in clock)	
		3	General data format (output time and date using the clock of the external equipment)	
	$Rr-d$ Zero after output	0	Not used	Adjusts zero automatically after data is output
		1	Used	

SIF Serial interface	bPS Baud rate	0	600 bps	
		1	1200 bps	
		▪ 2	2400 bps	
		3	4800 bps	
		4	9600 bps	
		5	19200 bps	
	btPr Data bit, parity bit	▪ 0	7 bits, even	Please Check
		1	7 bits, odd	
		2	8 bits, none	
	ErLF Terminator	▪ 0	CR LF	CR: ASCII code 0Dh LF: ASCII code 0Ah
		1	CR	
	tYPE Data format	▪ 0	A&D standard format	Refer to "10.6. Description of the Item "Data Format"".
1		DP format		
2		KF format		
3		MT format		
4		NU format		
5		CSV format		
t-UP Timeout	0	No limit	Selects the wait time to receive a command.	
	▪ 1	1 second		
ErEd AK, Error code	▪ 0	No output	AK:ASCII code 06h	
	1	Output		
nLt Programmable-unit (Multi-unit)	Sets an arbitrary coefficient.		Available only when programmable- unit mode is selected.	
Unit Unit	Refer to "5. WEIGHING UNITS".			
id ID number	Refer to "11. ID NUMBER AND GLP REPORT"			
AP Fnc Application	APF Application function	▪ 0	Normal weighing mode	
		1	Capacity indicator	
		2	Statistical calculation mode	
	StAF Statistical function mode output items	▪ 0	Number of data, sum	
		1	Number of data, sum, maximum, minimum, average, range (maximum-minimum)	
	2	Number of data, sum, maximum, minimum, average, range (maximum-minimum), standard deviation, coefficient of variation		
	3	Number of data, sum, maximum, minimum, average, range (maximum-minimum), standard deviation, coefficient of variation, relative error		
LocFnc	PASS	▪ 0	OFF	Refer to "14. PASSWORD LOCK FUNCTION".
		1	ON (limits weighing operations)	
		2	ON (enables basic weighing)	
	Loc na	AdnIN	Administrator password input	
		USEr01	User 1 password input	
		USEr10	User 10 password input	

\* : Only for the FZ-i /FZ-iWP /FZ-GD series    ▪ : Factory settings.

## Testing the communications

If the SuperTrickler is still warming up, or on the warmup ready screen, simply touch the screen to get the main menu.

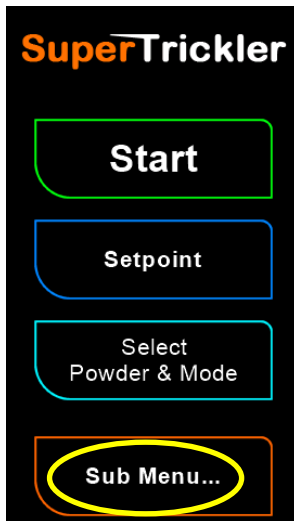

press the **[Sub Menu's]** button,  
then the **[System...]** button,  
then the **[Peripherals...]** button,  
then the **[Scales / Balance]** button.

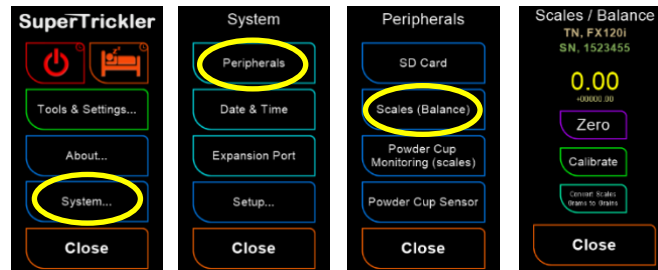

If communications are successful, you should see a screen similar to this.

Applying a small force to the scale plate should duplicate the scale value on the SuperTrickler display.

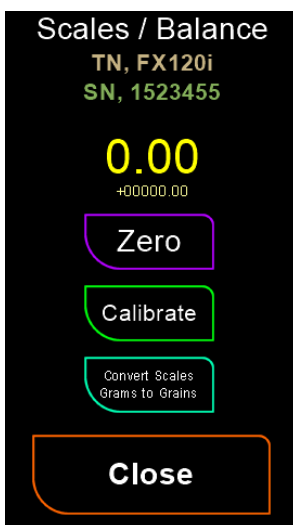

In the unlikely event that communications are not established, please check the serial communications setup/programming and the cable for damage or correct installation.

In the event unlikely event that you are unable to establish communications please contact your local dealer or our support email [support@superTrickler.com.au](mailto:support@superTrickler.com.au) (please allow up to a few days for the support team to respond as this service is not manned 24/7).

## Level & Calibrate the scale

It is recommended at this point to have the scale placed on a solid base, levelled, and calibrated, as per the installation and calibration guide in the A&D Precision Balance manual. Alternatively, you can use the SuperTrickler's calibration interface button on the Scales / Balance screen.

**NOTE:** a 50 or 100 gram precision weight will be required. It is recommended that the precision weight not be touched with bare skin and should be carried and placed with great care.

## Setting the clock

Before we have some fun, let's set the clock so that data logging and records will be accurate.

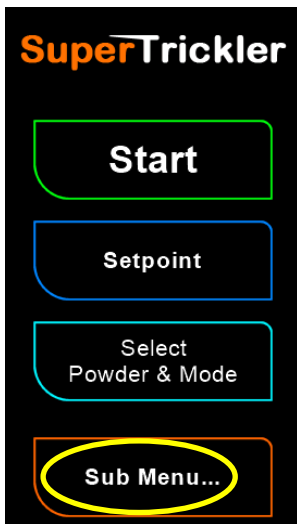

From the main menu press the **[Sub Menu]**'s button, then the **[System...]** button, then the **[Date & Time...]** button.

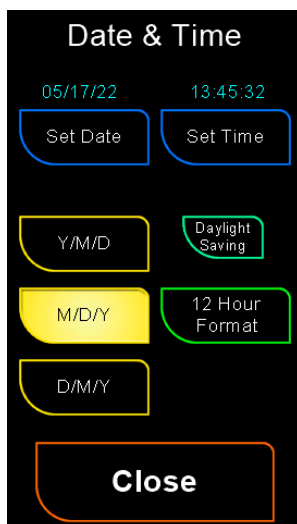
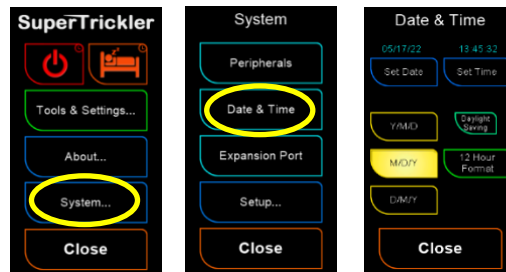

First select your preferred 'yellow' Date Format button, then your preferred 'green' 12- or 24-hour time format, then the 'light blue' daylight saving button should your area currently be in daylight saving time.

Now press the 'blue' **[Set Date]** button to set the current date, then the 'blue' **[Set Time]** button to set the current time.

When completed, press the **[Close]** button 3 times to get back to the main menu.

For additional information also see: System ↗ Date & Time

## Filling and Emptying the Gunpowder Hopper.

When changing powder, be sure that any spilled powder is removed from the scale and all the powder is removed from the SuperTrickler before new powder is added. Never mix different gunpowder.

### Filling

It is not recommended to load the hopper with more powder than is approximately required. You may choose to use a short funnel in the gunpowder hopper opening to aid the process.

1. Ensure the Micro SD card is installed, to stop any spilled powder entering the electronics bay.
2. Pour only smokeless gunpowder into the hopper. Do not fill the powder past the opening of the hopper.
3. If a short funnel was used, it may remain in the hopper if so desired.

### Emptying

You do not need to turn off or unplug the SuperTrickler to carry out this operation. You may also prefer to empty into a catching bowl, or you can empty the gunpowder directly into the original container with the aid of a funnel.

**Note:** The rotating bulk tube must remain in the SuperTrickler while emptying it.

1. Ensure the Micro SD card is installed.
2. REMOVE THE POWDER CUP.
3. Gently lift the SuperTrickler up from the scale (do not lift the scale). The cables are long enough to allow reasonable mobility of the SuperTrickler, but do not manipulate it to the point where it is tugging on the connections.
4. Tilt the SuperTrickler backwards to around 45° to expose the bottom and the hopper gate.
5. Place the SuperTrickler over a catch bowl or directly over the original container with a funnel.
6. Open the hopper gate fully and the gunpowder will begin to flow out.
7. Once no more powder is flowing, close the hopper gate and keep the unit angled backwards to around 45°.
8. Rotate the large bulk tube clockwise several times by hand, while gently shaking the SuperTrickler. Be careful not to touch the top vibrating tube (this needs no additional purging process).
9. Then again, repeat the process of opening the hopper gate to release the powder into the catch bowl or original container until no more powder flows.
10. Close the hopper gate and place it back onto the scale, ensuring that it is aligned and seated properly. **Note:** The SuperTrickler is designed so it cannot be seated back on the scale unless the hopper gate is fully closed.

**Warning:** Do not force SuperTrickler onto the scale. If the hopper gate is not fully closed, you may damage your scale.

## Quick Start – let’s have some fun.

**Do not load any bullets with powder dispensed by the SuperTrickler until you have read and understood this owner’s manual.** We also know it’s nice to have a play and gain some familiarity before scrolling through a comprehensive manual. So let’s begin with loading the hopper with gunpowder then selecting a powder and dispensing a charge.

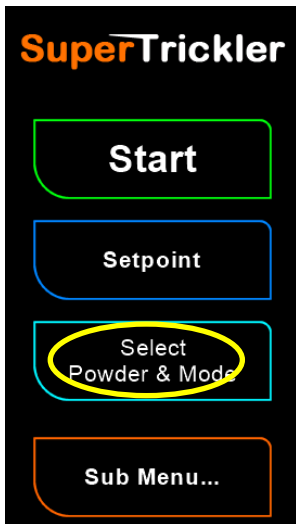

From the main menu press the **[Powder...]** button, then again, the **[Powder...]** button, then the **[Select...]** button, find the powder brand in the list – use the scroll **[Next]** & **[Back]** button to find more selections. Once the powder brand has been found, press that button to select the type of powder in the same manner.

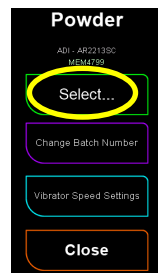

If you like, you can also enter the powders batch number for the record.

Now that the powder has been selected, you will see a yellow ‘No Profile Found’ indicator flashing along with the Vibrator Speed Settings button indicating that the system will need to know the best minimum and maximum speeds for the vibrator tube. Press the **[Vibrator Speed Settings]** button.

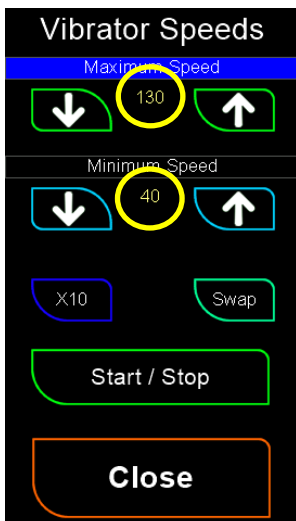

These settings set the minimum and maximum speeds of the vibrator motor from a value between 1 and 255. Once set, the range will be represented by the rest of the system as a percentage of minimum and maximum setting speeds. Use the arrows to change the values, and the x10 button to change by 10 or by 1 for each press. To change between Maximum and Minimum either press the swap button or tap the appropriate heading.

Min is the value that represents 1% speed.

Max is the value that represents 100% speed.

Set the Maximum speed high enough to obtain as high a flow as practical without having the kernels miss the cup. (Too fast and the kernels will overshoot the cup)

Set the Minimum speed low enough so a single or a small number of kernels are dispensing from the tube.

Once complete, press **[Close]** three times to get back to the main menu.

From the main menu, press the **[Setpoint]** button to set the desired charge – this will take you directly to the dispensing screen.

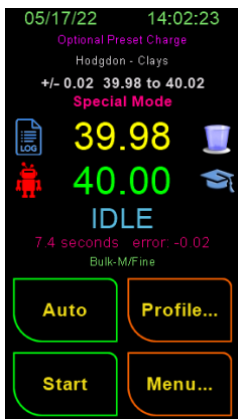

From the main screen the scale value is shown in yellow, and the charge set point is shown in green (in this case 40.00 grains).

Place an empty powder cup on the scale plate.

Pour some powder into the SuperTrickler's hopper.

Press the **[Auto]** button if you like (this will save hitting start for every run).

Then press Start.

The SuperTrickler will begin trying to dispense powder, however the trickler tubes will most likely be un-primed (we will learn how to do this later), so you may find after about 5 seconds a, DISCARD error will appear with a "No Weight Detected" message. Just press Start again and repeat until the powder begins to flow from the bulk tube.

As there is no profile, nothing is known about the characteristics of the powder. At this stage the simplest solution is to let the Artificial Intelligence (AI) work it out by trial and error. The first several attempts will always fail, as the AI discovers the powder's dynamics. All loads can simply be poured back into the powder hopper.

After a few goes the AI will have figured out the powder dynamics and will continue to do so until (by default) 10 successful charges have been produced in a row, then the self-learning will be disabled, and the little scholar's hat will disappear from the dispensing screen.

Congratulations – you just discover how easy the SuperTrickler is use! Had the scale been warmed up correctly, levelled, and calibrated, your load would be good to go.

**LEGAL REMIINDER: Do not load any bullets with powder dispensed by the SuperTrickler until you have read and understood this owner's manual.**



## The trade-off between speed and failures.

Powder and granules are notoriously difficult to dispense. Given enough time, you can slowly trickle the powder for an accurate charge every time. However, is this the best approach?

The trade-off: You can go fast and have a few failures every now and then or go slow and rarely have a failed charge. We are all different, so the choice is yours. You may prefer to charge fast and discard overcharges, or you may prefer to charge slower and rarely discard overcharges.

Do not expect 100% successful charges, unless you want to trade dispensing speed for time.

If you were to do 100 charges at no failures, but each charge was 20 seconds, the total time would be 33 minutes and 20 seconds.

Now let's look at the same scenario if each charge took only 6 seconds, but with a 1 in 10 failure rate. The total time would be 11 minutes, a saving of 22 minutes and 20 seconds.

Even if the charge time was 10 seconds, with a 1 in 10 failure rate, the total time would still only be 18 minutes and 20 seconds. This is a 15 minute saving in time for the sake of a few rejected overshoots. Do not be concerned with a few overshoots if you can save considerable time, but the decision is yours.

## Micro SD Card

The SuperTrickler utilises a Micro SD card that has four core functions.

1. The first is to act as solid-state drive to hold the systems several databases.
2. The second functionality is to hold the .CSV log files containing the successful and failed charges.
3. The third is to store a record of the system settings for support analysis.
4. The fourth is for firmware updates.

**WARNING:** The micro-SD card itself acts as an ingress barrier into the electronics and it is very important not to load or empty the powder hopper when the card is removed.

### Card Type

The maximum card size that is supported is 32GB. When replacing the card, a high-quality SD card such as a Kingston or SanDisk, is highly recommended. A cheaper card may work reasonably well, but may slow your system down considerably. Further to this, a cheaper card may not support the firmware upgrades, as this is very card quality dependent. The card must be fully SD Association compliant.

### Card Format.

It is critical that you use the SuperTrickler formatting function and not use a card formatted by a personal computer. Often personal computers do not format to the SD Association specifications. The card might work in general but may not support the firmware updates.

Please see the System – Peripherals – SD card, for details on how to initiate the card formatting function.

### Card Removal and Insertion.

To remove the SD card, press on the card then release, and the card will release to the upper position for removal with your fingers or tweezers.

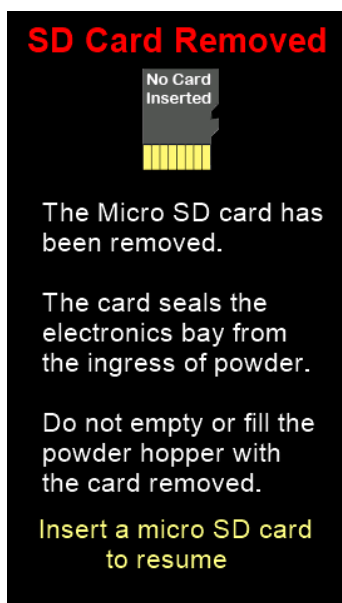

In most cases when the card is removed the SuperTrickler will display a warning screen (shown to the left) and will not function until the card is inserted.

To insert the card, place the card with the gold terminals facing the front of the machine, then gently insert it into the SD card slot. Once the card in the slot, press it down until it clicks into position.

**Warning:** Do not remove the card (or turn off the power) while a charge is taking place, unless the display is showing IDLE, or while a firmware upgrade is in progress or while formatting an SD card. The removal of the card or loss of power during a firmware update may permanently damage your SuperTrickler.

## Menu System

The menu system is based around workflow and practical application. It is broken down into 3 main sections: Dispensing, Operational, and System.

1. *Dispensing* is the main functionality of the SuperTrickler, and as such, the core requirements are directly accessible from the main menu.
2. *Tools and settings* is the "Operational" menu with all the general functionality and options that an operator may require.
3. *System* is the deeper functionality; configure, restore, and test.

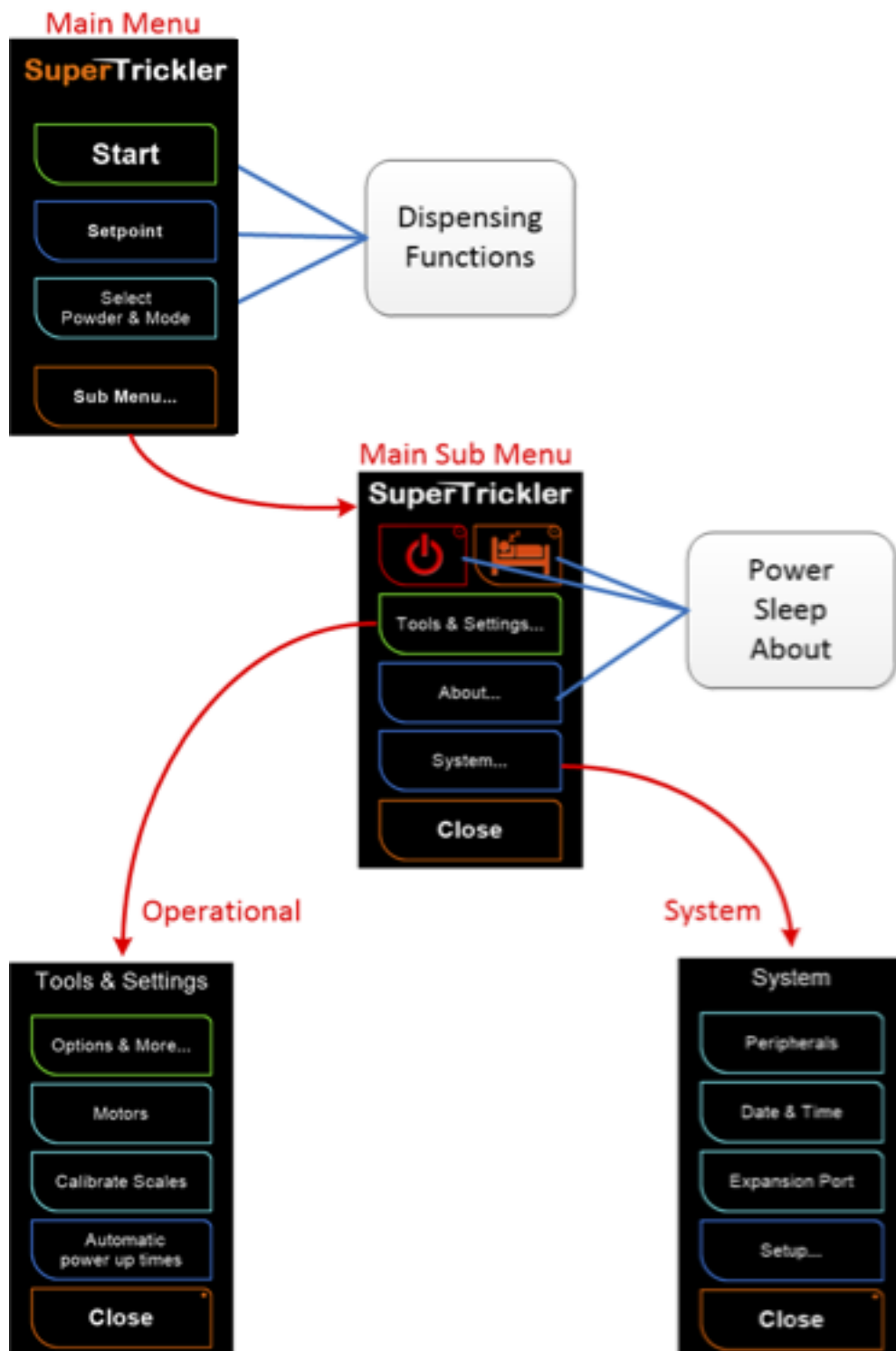

## Special Buttons.

There are two types of special buttons that you find throughout the system.

### Hold to activate



Any button in the system that has a small clock in the top right-hand corner will need to be held in for a time before activation will occur. This feature is designed to ensure that these particular buttons are not accidentally hit, causing unintentional activation. The green work light will flash once timed out.

### Quick Return



Some of the menu close buttons will have a dot in the top right-hand corner. This indicates that the button is a quick return button and works as follows...

- Pressing the button normally (finger on, finger off quickly) will return you back to the previous menu.
- Pressing and holding the button for around 1.5 seconds will return you the Main Menu screen.

## Main Sub Menu

Called from the Main Menu, the main submenu is the gateway to the many functions and features of the SuperTrickler.

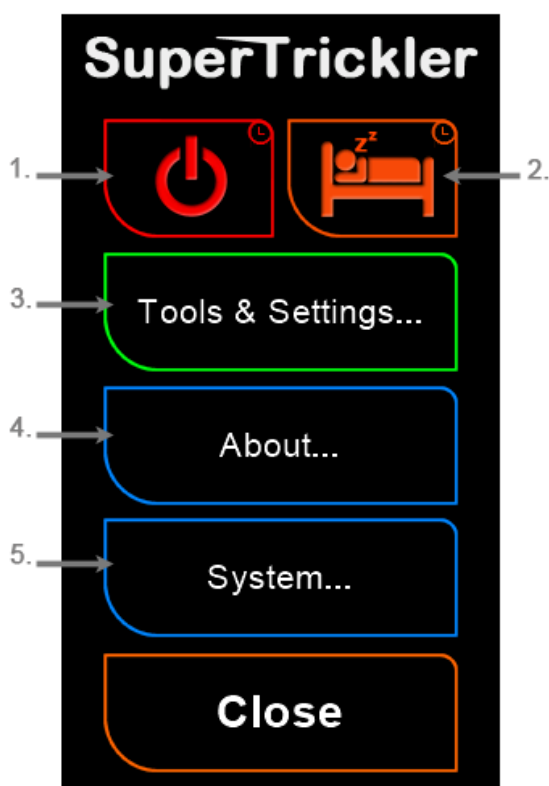

1. Power down turns off power to the scale and puts the SuperTrickler into hibernation. To reactivate the power, simply touch the blank screen.

2. Sleep will turn off the scale display but leaves the power on to keep the scale in a ready state, while the SuperTrickler goes into hibernation. To reactivate the system, simply touch the blank screen.

3. Tools & Settings... will give access to the operational mainstream tools & settings menu.

4. About... will display information about the SuperTrickler, including the serial number and powder file version date. The QR code is an email link to [support@supertrickler.com.au](mailto:support@supertrickler.com.au)

5. System... will take you to many submenus, giving you access to such things as system setup, peripheral devices, the date and time and the expansion port setup.

## Soft keypads

The SuperTrickler has two soft keypad systems, designed to make entry clear and easy. The two keypads are a numeric keypad used to enter numeric data and the alphanumeric keypad that allows you to enter text.

### Numeric Keypad

Is the most used soft keypad, and is flexible in functionality. The numeric keypad has two flexible soft keys that will change according to the type of values being entered. An example of this is the entry of the date or time; where the spacer will change to '/' for dates and ':' for time. In the case of date and times the system will generally automatically populate the date and time spaces as required.

**Note:** Often the system will either limit you to an entry range, change, or automatically change the value if it's out of range.

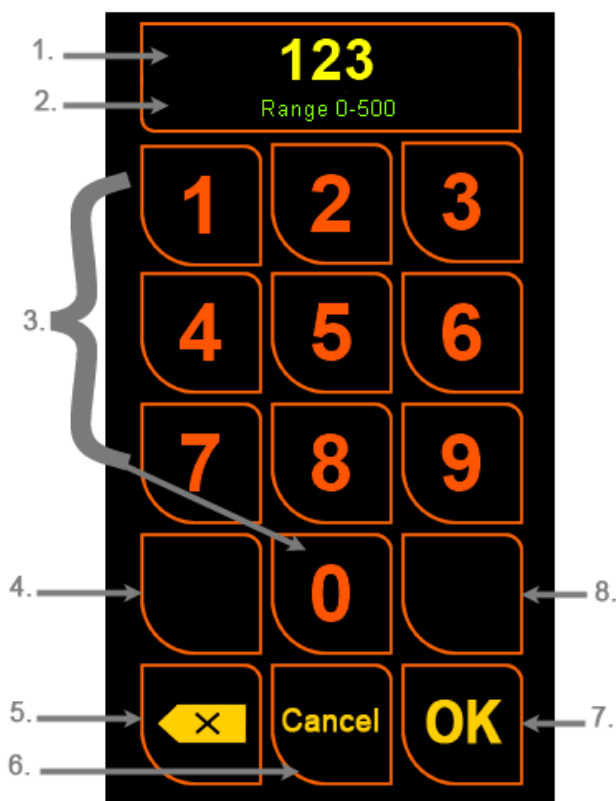

1. The entered value display.
2. Prompt display. This contains information relating to the value you are entering.
3. Number keys.
4. Left soft key. This can be blank or have the following functionality....
  - ± = Toggle the value between positive / negative
  - (+/-) = Add the entered amount to the existing value
  - am/pm = toggle between am and pm time
5. Backspace.
6. Cancel the entry and exit.
7. Accept the entry and exit.
8. Right soft key. This can be blank or have the following functionality....
  - . = Decimal
  - / = Date spacer
  - : = Time spacer

## Alphanumeric Keypad

The alphanumeric keypad is designed to allow you to enter a text string of alphanumeric characters both in upper and lower case, punctuation and symbolic characters. Because of the limited size of the display, the alphanumeric keyboard is split into multiple sections, accessible by using the key range scroll buttons.

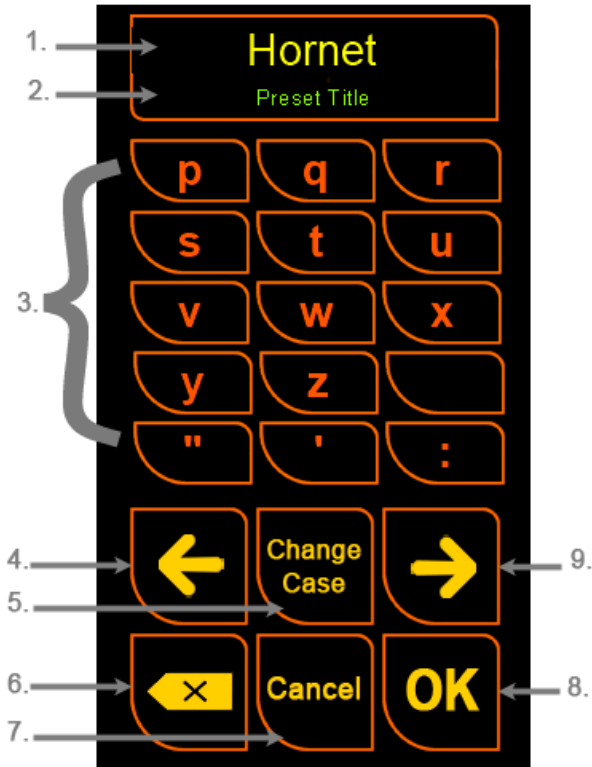

1. The entered text string display.
2. Prompt display. This contains information relating to what you are entering.
3. Text keys.
4. Key range scroll left.
5. Toggle the case of alphabetical keys.
6. Backspace.
7. Cancel the entry and exit.
8. Accept the entry and exit.
9. Key range scroll right.

## Dispensing

### From the Main Menu

The main menu is the central point of the system. The first three buttons represent the main stream core of the dispensing functionality; selecting a powder, a set point and starting the dispensing.

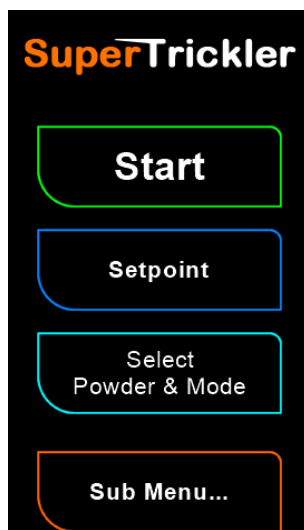

**Start:** will take you to the dispensing screen to begin the dispensing process.

**Setpoint:** allows you to change the charge target set point (amount of powder in weight). Once the charge is set you will be taken directly to the dispensing screen.

**Select Powder & Mode:** will take you to a submenu, allowing you to select the powder or pre-set charge and Charge Mode.

## Dispensing Screen

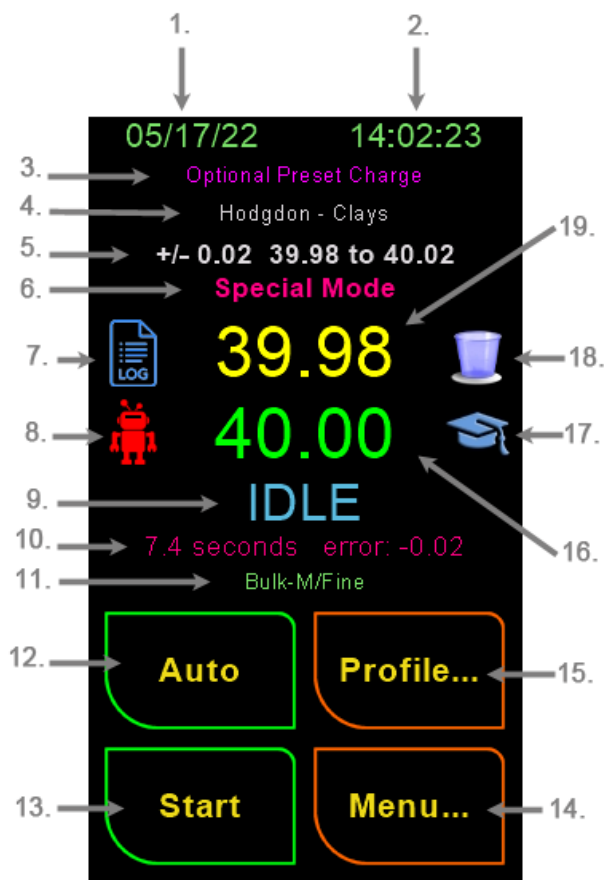

1. Date.
2. Time. **Note:** The seconds update is disabled during a charge cycle.
3. Optional pre-set charge name.
4. Powder brand and type.
5. Tolerance level and tolerance range.
6. Special mode (ladder or top up).
7. Shows if the successful charge log file is enabled.
8. Shows if the robot interface is enabled.
9. Show the operational status, success and discard messages.
10. Charge results, time and charge error amount.
11. Shows how the AI made the charge. Useful in fine-tuning and error analysis.
12. Automatic operation mode button.
13. Start charge button.
14. Return to the main menu button.
15. Powder profile settings button.
16. Set Point amount - touching this will allow you to change the set point.
17. Shows if the AI self-learning is enabled.
18. Shows the powder cup status and errors.  
\*See below
19. Shows information and scale weight.

\* When an instrument is running the cup display will be replaced with crosshair picture . When pulsing the picture will toggle on and off at the start of each pulse.

## Charge Setpoint

Setting the charge setpoint can be achieved by two methods and is a simple matter of entering the value into the keypad and pressing OK.

Method 1. Is from the main menu, pressing the **[Setpoint]** button.

Method 2. Is from the dispensing screen, by pressing the set point value field. See point 16 above.

## Selecting a Powder or Pre-set

From the main menu selecting **[Powder]** will take you to the selection screen, from where you can select either a powder or a pre-set.

## Powder & Pre-set Profile Database

The characteristics of every powder are different. The SuperTrickler has a database on the micro-SD card that keeps a record of every powder. Thus, the characteristic of a given powder is known the next time that powder is selected. The characteristics 'profile' for that powder will be loaded into the system. Where no profile has been recorded, the system will create a record using a default profile template.

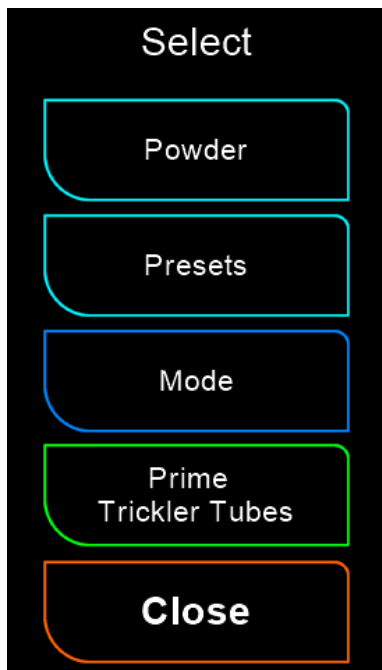

The SuperTrickler's AI will learn the characteristics of the powder on the fly during the charges. In most cases this is more than adequate, however in some circumstances the profile may need to be manually altered to give you the best results.

**NOTE:** It is highly recommended to prime a new powder before starting the charge by holding the **[Prime Trickler Tubes]** button.

**Mode:** Will allow you select the mode of operation, Normal, Ladder or Top-up modes.

## Selecting a Powder

Pressing the **[Powder]** button from the select menu takes you to the powder submenu.

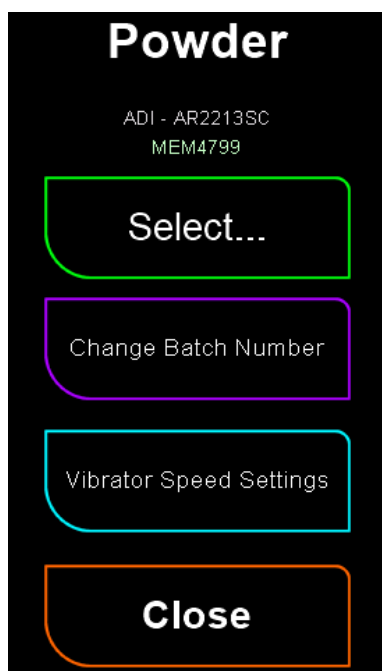

**Select:** will take you to an extensive list of powders currently on the market. The list is broken down into two sections: firstly, the powder brand (manufacture) and secondly, the powder type or name.

**Change Batch Number:** in some countries the recording of powder batch numbers and usage is a legal requirement. Also, it is not unusual for precision shooters to keep a record of the powder batch with their loads. The batch number is recorded in each powder's profile record.

**Vibrator Speed Settings:** This will allow you to change the vibrating motor speed range. The actual speed range represents 1 to 100%.

**Important: This must be set when an un-profiled powder is selected.**

**Note 1:** The powder selection list is a simple text file on the micro SD card (\Powder.txt) and can be edited with any text editor and rearranged to suit your needs if desired.



**Note 2:** For the latest powder database go to the download area at: <https://supertrickler.com.au>  
Download the file and copy it to the root directory of the SuperTrickler's Micro SD card.

## Pre-set Charge Profile Database

The SuperTrickler allows for an unlimited number of pre-set charges to be added. The pre-sets are an extended profile of the powder profile, containing additional information and treated as a separate profile than that of the powder profiles. The pre-sets are organised as headings and under each heading a group of pre-set names. There is no limit to the number headings and or pre-set names and are organised as in this example.

### Heading 1

Name 1  
Name 2  
Name 3  
.... (Unlimited Names)

### Heading 2

Name 1  
Name 2  
Name 3  
.... (Unlimited Names)

### Heading 3

Name 1  
Name 2  
Name 3  
.... (Unlimited Names)

.... (Unlimited Headings)

The additional fields held in a pre-set are as follows...

1. Pre-set Heading
2. Pre-set Name
3. Charge Set point.
4. The shell (cartridge) volume.

**Note 1:** The pre-set menus allow you to change the 'powder batch number', however, this information is not stored in the pre-set profile. Rather, it is stored separately, and shared with the Powder Profiles information. (Changing the batch number in either the powder profile or the pre-set profile, changes the same data.)

**Note 2:** An advantage of using a pre-set over a simple powder profile is that the volume of the cartridge (shell) can be recorded. When dispensing, the percentage of the volume used by the charge will be displayed and logged in the 'loads.csv' log file.

## Selecting a Preset profile

Pressing the [**Presets**] button from the select menu will take you to the preset's submenu.

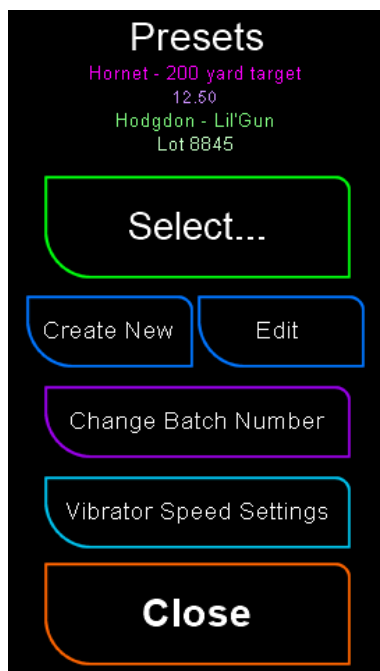

Pre-sets are an easy way to select common loads and (like the powder) is a simple list of headings and sub-headings. An example may be a heading of 'Hornet', then a sub-heading selection of '200-yard target'.

When you first create a pre-set, you must also select a powder brand and type. If the profile exists for the powder selection, then it will be copied into the profile of the pre-set, otherwise the default will be used.

**NOTE:** The pre-set profile will run its own profile and not the powder's profile; any changes to the pre-sets profile will not change the original powders profile; however, the powder batch number is linked to the powder's profile.

**Vibrator Speed Setting:** This will allow you to change the vibrating motor speed range. The actual speed range represents 1 to 100%. **Important: This must be set when an un-profiled powder is selected.**

## Creating a new pre-set

There are several fields to populate when starting a new pre-set. Some of these fields can be selected from existing headings or can be created from scratch using the alphanumeric keypad.

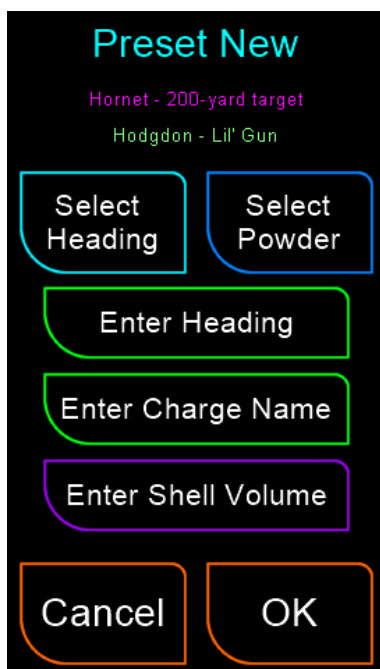

**NOTE:**

1. The sub-heading or 'Charge Name' is required.
2. A powder brand and type must be selected.
3. The shell (cartridge) volume is optional.

### Editing a Pre-set

To edit pre-set, select the field that requires changing. When selecting a new powder; if the profile exists for the selected powder that profile's key values will populate the pre-set and if no profile exists then the default profile will be used.

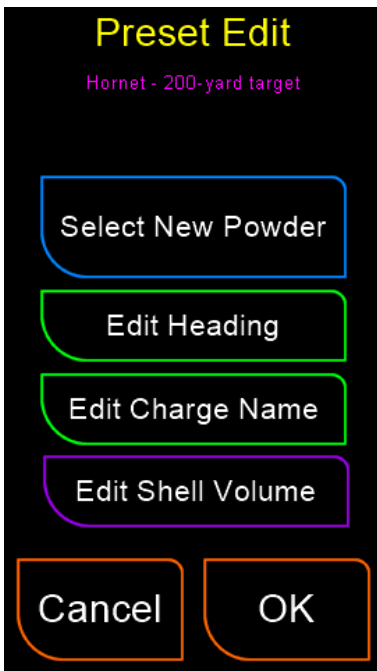

### Modes

The SuperTrickler has three modes of operation.

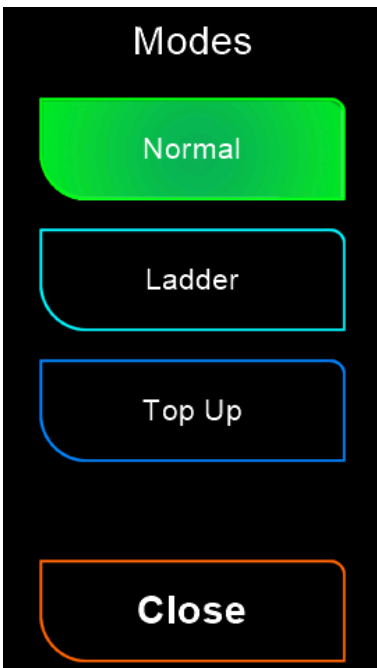

**Normal**: this is the standard operational mode.

**Ladder**: this mode will generate a ladder of charges.

**Top Up**: used if the SuperTrickler is used to only complete a charge rather than dispense the entire charge.

Both Ladder and Top Up require additional information and settings for that mode. When either of these two modes are in operation, the Dispensing Screen will display a mode setting (see the Dispensing Screen above item 6.). In the case of Top Up mode, the indication will flash, highlighting the caution needed in this mode.

### Ladder Mode

Ladder Mode is designed for ladder testing, which is making a range of loads to find the specific charge that is most accurate. The system is designed to be flexible, when entering any value into the green fields the SuperTrickler will calculate the other green field values, based upon the number of steps entered in the blue field. All green fields are rounded down to a resolution equivalent to the scale resolution (0.02 gr).

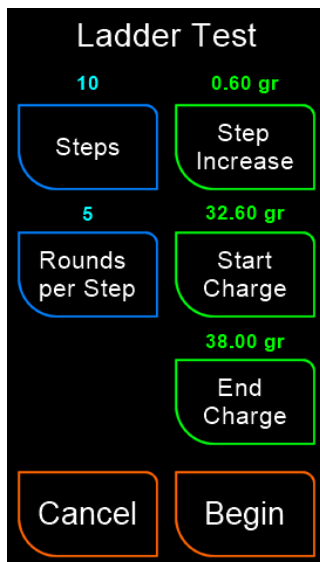

There are five parameters required for a ladder test.

The Number of ladder Steps (change in charge set point).

The Number of Rounds per Step (per charge).

Step Increase (step weight increase amount).

The Start Charge.

The End Charge.

After entering the number of steps, it is common to first enter the Step Increase and then the End Charge value, being the theoretical maximum charge weight; letting the system work backwards and calculate out the Start Charge value.

Once you are satisfied with the ladder parameters, pressing “Begin” will take you directly to the Dispensing Screen, ready to begin.

**Warning:** Check that **all** the green fields are within the specifications you require before beginning the ladder operation.

### Top Up Mode

The top up mode was requested by some users, where they only want the SuperTrickler to make the final accurate charge.

**WARNING:** You cannot use multiple powder cups in this mode.



There is one parameter and one measurement required.

The charge target set point must be entered. This is the value to which the SuperTrickler will top up the charge.

The other is measurement of the empty powder cup weight.

Once the cup weight has been measured, the “Begin” button will be enabled, allowing you to then press “Begin”, then taking you directly to the Dispensing Screen to start the process.

**NOTE:** Under normal operation the scale is zeroed at the start of each charge to maintain the best possible accuracy. However, in this mode this is not possible. It is recommended to periodically reselect the top up mode and remeasure the cup weight.

## Operational

The operational part of the system is the Tools & Settings menu, where options and functions that may be required in the general operation of the SuperTrickler can be found.

### **Tools & Settings Menu** *Menu, Submenus*

The Tools & Settings menu is the starting point of the many mainstream operational functionalities.

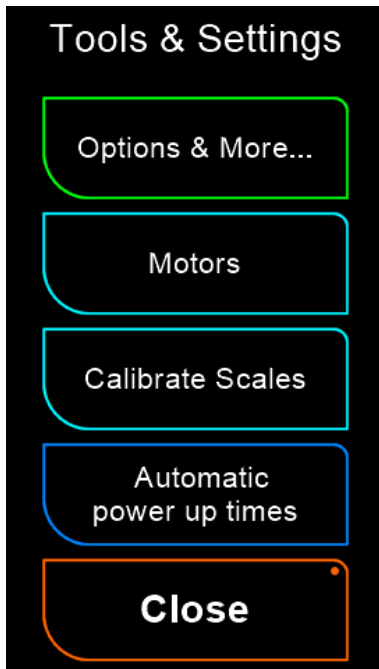

**Options & More...**: will take you to the many mainstream options and statistics.

**Motors**: allows you to prime, purge, test, flow test and change the bulk trickler tube.

**Calibrate Scales**: use the SuperTrickler interface to calibrate the scale.

**Automatic power up times**: is an easy system to quickly setup automatic power up times, allowing the SuperTrickler to be warmed up and ready when you are.

### **Options & More** *Menu, Submenu's, Tools & Settings*

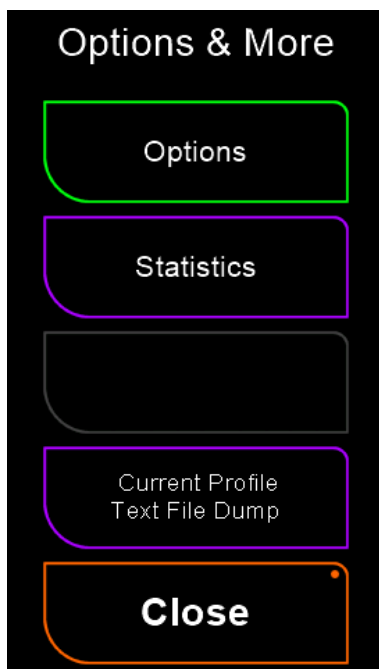

**Options**: will take you to the many options, such as: display brightness, start-up options, automatic power down and sleep, audio options, data logging, work light options and external robot control.

**Statistics**: will take you to a screen that displays system metrics etc. Important information included is the 'Current Powder Used'. This is reset whenever the powder is changed.

**Current Profile Text File Dump**: Saves the current profile to the SD Card in the root directory in profile.txt. Currently this file for support purposes only.

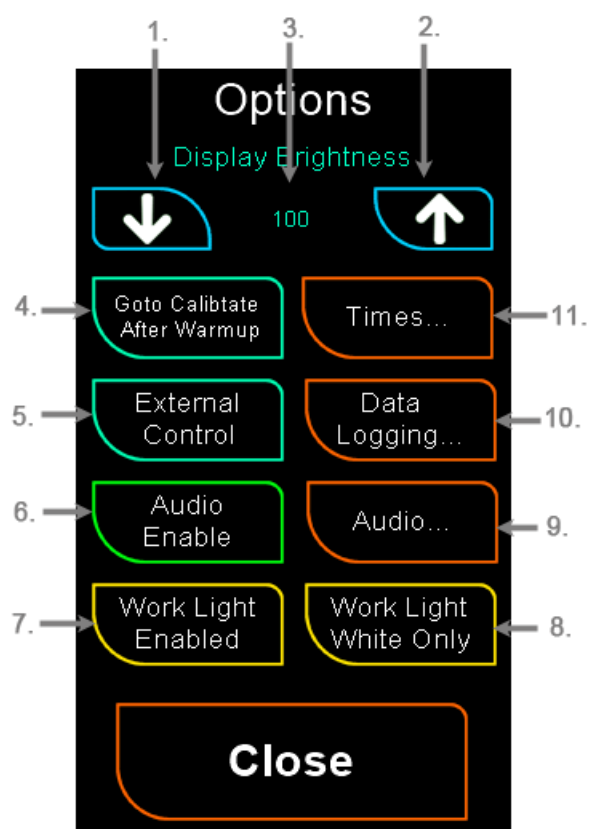

1. Display brightness – dimmer.
2. Display brightness – brighter.
3. Display brightness value.
4. Enables SuperTrickler to automatically go to the calibration screen once the system is warmed up and ready. We highly recommend regular calibration and this system makes it easy.
5. Enable external (robot) control.
6. Enable the audio beeper.
7. Enables the work light.
8. Disables the use of colors with the work light.
9. Audio setup sub-menu, this allows you to change the tones of many of the various beeps. For anyone with impaired hearing, these settings can allow you to control pitch of the alerts and tones.
10. Data logging submenu, used to enable the logging of failed and successful loads, this will also show the remaining micro-SD space.
11. This submenu enables you to setup warm up times, power down and sleep times.

### Times Option

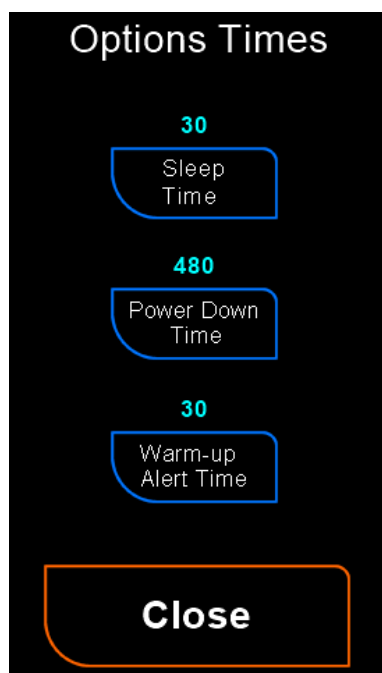

**Sleep Time:** (in minutes) after this time, when no activity is detected, the system will go into sleep, turning off the scales display only and puts the SuperTrickler into hibernation. To reactivate, touch the screen. A value of 0 will disable this function.

**Power Down Time:** (in minutes) after this time, when no activity is detected, or the system is sleeping, the system will power down. It will turn off the power to the scale and puts the SuperTrickler into hibernation. To reactivate, touch the screen. A value of 0 will disable this function.

**Warm-up Alert Time:** (in minutes) when powered up, the system will wait until this time, then turn on an audible alarm and display a ready alert screen. A value of 0 will disable this function.

### Audio Option

The main options page has an option to disable the audio beeps. This is for convenience in the event that you do not desire the beeps. For example: if reloading in your kitchen or late at night when the beeps can disturb others.

Many people have difficulty hearing certain ranges of frequency (pitch). These options allow you to change the pitch or turn off some of the key alerts.



**Touch:** this is the sound whenever you touch the screen.

**Warm-up:** this is the alert sound you hear when the warm-up time has expired.

**Success:** is the “charge successful” alert.

**Discard:** is the “charge failed” discard alert.

### Data Logging

The data logging ability of the SuperTrickler is an important feature. There are two main log files stored on the micro-SD card. The log file size is limited to 3.9 gigabytes (4294967295 bytes), an enormous amount of data. For more detailed information see the “Charge Log Files” later in this document.

There are two separate log files, one for successful charges (loads.csv) and the other for failed charges (error.csv). The error file, logs failed loads and contains all the same fields as the successful loads, with additional information that can be used by our support team to analyse the reasons why the failed load occurred.

#### Data Logging Option



When you first open the logging options page, an hourglass will appear while the system reads the files sizes and free space.

Once open, you can turn on or off either of the log files; however, it is highly recommended to always leave the failed log file running. The button will be highlighted when ON.

Holding the **Delete** buttons will delete the existing file and recreate a new file.

**Log Powder Every Line:** toggles between logging modes. See the *Charge Log File* section for details. If you are going to change the style, it is suggested to back up and rename the old log file first to mix the formats.

## Motors *Menu, submenus, Tools & settings*

This screen is for common motor function and testing to establish motor speeds and powder flows.

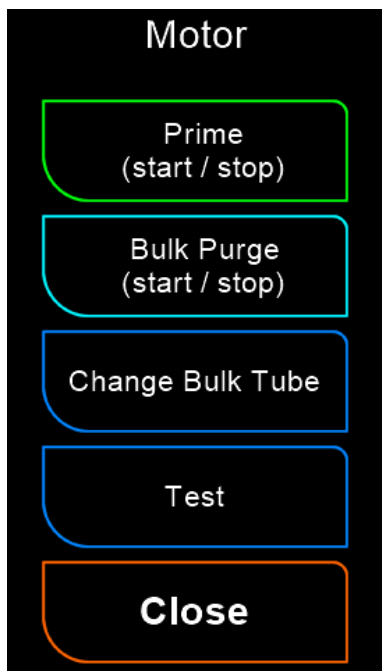

**Prime:** is used to prime the trickler tubes when a new powder is added to the system.

**Bulk Purge:** will run the bulk trickler in reverse to help empty the tube.

**Change Bulk Tube:** takes you to a menu that assists in the removal and installation of the bulk trickler tube.

**Test:** will take you to the motor's testing functionality.

### Change Bulk Tube

This functionality is designed to assist you in removing and installing the bulk trickler tube.

**Warning:** Do not remove the bulk trickler tube with powder in the hopper. Doing so will allow powder into the body of the unit and will require cleaning from an authorised service center, at your cost.

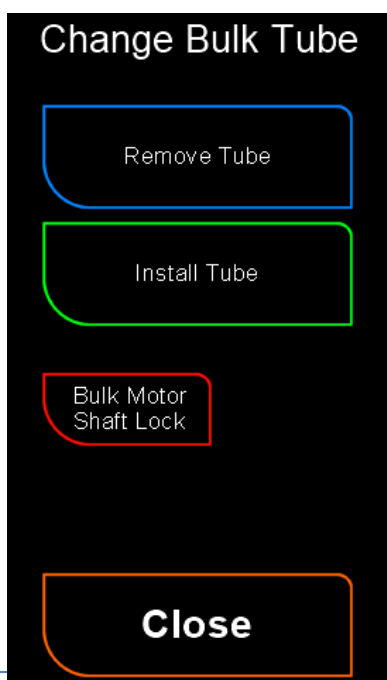

**Remove Tube:** will run the motor in reverse for around 10 seconds. By holding the end of the bulk tube during this time, the tube should easily unscrew itself.

**Install Tube:** will run the motor in forward for around 10 seconds. Holding the end of the bulk tube, place it against the threaded motor shaft and allow it to screw on, until the motor stalls, then release the tube. Be careful to not cross thread the tube.

**Bulk Motor Shaft Lock:** will lock the bulk motor's shaft for 10 seconds, to assist in the removal of the bulk trickler tube, in the event the above methods are unsuccessful.



## Motor Testing

This functionality is designed to test motor speeds and flows for best performance with a given powder and when manual profile alterations are required.

The screenshot shows the 'Motor Test' interface with the following elements and callouts:

- 1.** Speed: Points to the '86' value under 'Motor Speed 1 - 100%'.
- 2.** Speed DOWN 1 unit: Points to the top-left arrow button.
- 3.** Speed DOWN 10 units: Points to the bottom-left arrow button.
- 4.** Speed UP 10 units: Points to the top-right arrow button.
- 5.** Speed UP 1 unit: Points to the bottom-right arrow button.
- 6.** Enable bulk motor: Points to the 'Bulk' button in the 'Motors Select' section.
- 7.** Enable fine motor: Points to the 'Fine' button in the 'Motors Select' section.
- 8.** Set the run time: Points to the 'Timer' field showing '10'.
- 9.** Start and/or stop the test: Points to the 'Stop Start' button.
- 10.** Bulk motor direction. On is reverse: Points to the 'Dir' button.

At the bottom of the interface is a large 'Close' button.

## Calibrate Scales Menu, Submenus, Tools & Settings

The SuperTrickler scale calibration is just an easy interface into the standard calibration system. The process takes you through the calibration procedure in steps

The screenshot shows the 'Scales Calibration' interface with the following elements:

- A 'Begin' button (highlighted with a red border).
- A 'Continue' button (disabled, greyed out).
- Yellow text instructions: 'Remove all objects from the platen. Then press Begin'.
- A 'Close' button (highlighted with a red border).





**NOTE:** You will need a precision standard 50 or 100 gram weight. It is highly recommended that you never touch your calibration with your bare hands, as your skin oils can change and damage the weight.

Once you have entered the calibration page, it is simply a matter of following the instructions as they appear.

### Scale Calibration Weight

The A&D FX-120i scale can be calibrated with either a 50 gram or 100 gram precision standard weight. The default is for a 100 gram weight, and that is what is recommended. Should you require using a 50 gram weight, see below.

To set the scale for a 50 gram precision standard weight.  
With the scale running and ON.

Steps	Button	Instruction	Display	Information
1		Press <b>Cal</b> for 2 seconds	cal 0	Calibration
2		Press <b>SAMPLE</b>	100.000	100 gram weight
3		Press <b>Mode</b>	50.000	50 gram weight
4		Press <b>PRINT</b>	cal 0	Save change
5		Press <b>Cal</b>		Exit calibration change

Note: Repeat the steps to change back to 100 grams calibration if required at any time.

### Automatic power up times Menu, Submenus, Tools & Settings

Automatic power up times enables you to have a preset time for a given day when you would like your SuperTrickler to be warmed up and ready. The SuperTrickler will take into consideration the warm-up time if set in the options “options ▶ times ▶ Warm-up Alert Time”

**NOTE:** The SuperTrickler will wake from a sleep or power down state should it be in that mode when the wake-up call is initiated.

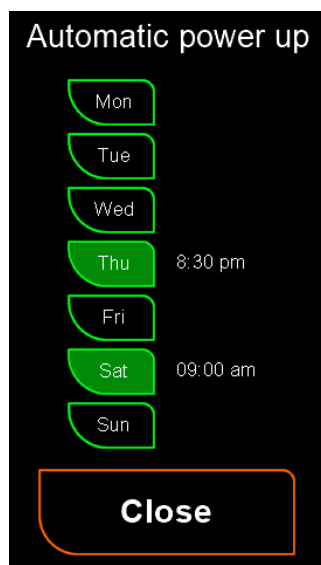

To set a time:

Press the day button, then on the keypad enter the time the SuperTrickler is to be ready, then press OK.

The time will be displayed on the screen, indicating its activity. This will repeat on this day until you disable it. Enabled days will be green.

To disable time:

Simply press the day button that you require to be disabled.

To re-enable a time:

Press the day button and the previous time used will be automatically added to the keypad. You can either change this time or simply press OK to accept the previous time.

## System

The system section of the SuperTrickler contains all the non-mainstream functionality, deep settings, configuration, factory restores, upgrade and testing facilities.

### System Menu *Menu, Submenus*

The system menu is the gateway to the many system settings, configuration and diagnostics.

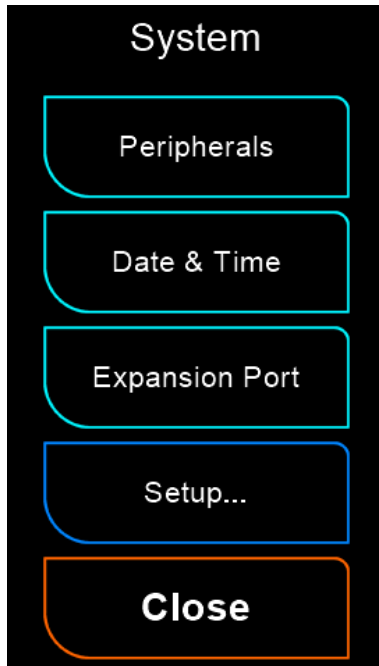

**Peripherals...:** are the sub devices attached to the SuperTrickler. These are the micro-SD card device, the scale, and the powder cup laser sensor.

**Date & Time...:** to set the current date and time. This functionality includes the date, time formats and daylight savings switch.

**Expansion Port...:** to configure expansion port options and functionality.

**Setup...:** is the system setup menu for; configurations, firmware updates and factory restore functionality.

### Peripherals *Menu, Submenus, System*

The system peripherals are devices integral to the standard operation of the SuperTrickler.

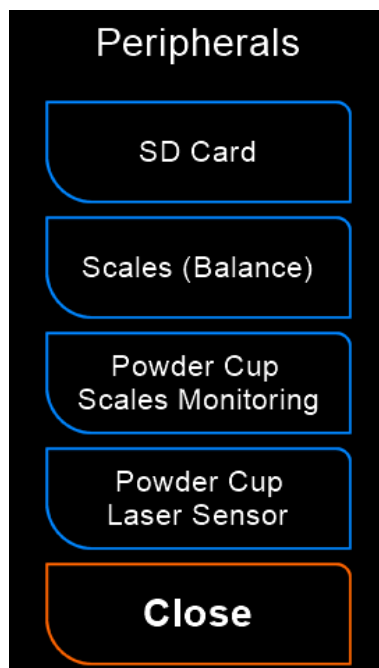

**SD card:** will give information about the installed micro-SD card, formatting and recreating the data structure can also be performed from this page.

**Scales (Balance):** allows you to diagnose the data stream from the scale and to configure the operation settings. Scale calibration is also available from this screen.

**Powder Cup Scales Monitoring:** is the setup that controls the powder cup monitoring using the scale.

**Powder Cup Laser Sensor:** is an optional laser, that will monitor the cup in addition to the scale weight data. This screen will enable the operator to read the laser operation in real time and to set its operational parameters. (Note: This feature is experimental at this time, use with caution.)

## SD Card *Menu, Submenus, System, Peripherals*

The SD card contains log files and the database for powder profiles and custom pre-set profiles, along with several other system files.

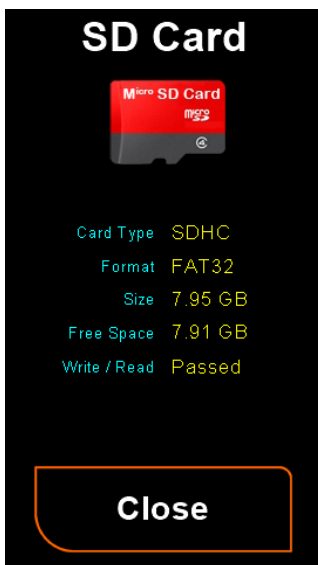

When you first open this page the SD card details will be displayed, however the free space and Write / Read test will take a few seconds to display.

Note: The Free Space is displayed as Gigabytes (GB) when its above 1 GB and below this the value will be displayed in Kilobytes (KB).

### *Formatting the SD card.*

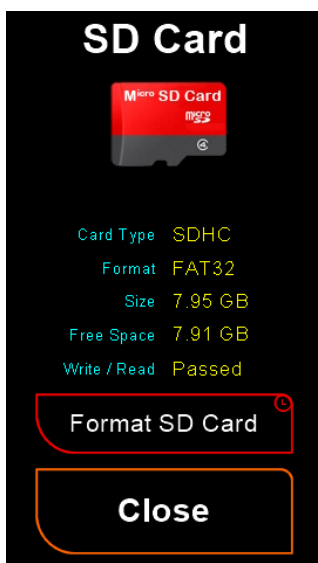

It is critical that you use the SuperTrickler formatting function and not use a card formatted by a personal computer. Often personal computers will not use a fully  SD Association compliant format. The card might work in general but may not support the firmware update functionality that is card-format critical.

Warning: all data, log information and system support information will be lost when formatting. Should you wish to keep all your data and just upgrade or replace the card you can simply copy all the data on the old SD card into a personal computer, then format the new card using the SuperTrickler. After the formatting has completed, simply copy the data back onto the newly formatted card. The format function will automatically add some system files and folders and you can overwrite these with the old data.

### *How to invoke the format function.*

The format function is not immediately available to the operator, this is to prevent accidental formatting.

Step 1. Press and hold the Micro-SD card picture for 2 seconds (after the Write/Read test has completed) *this will enable the Format SD Card button.*

Step 2. Press and hold the 'Format SD Card' button for 2 seconds and the format will begin.

An hourglass ⌚ will be displayed during formatting and the screen will be refreshed when finished.

**Warning: Removing the card or the loss of power during the formatting process may destroy the card.**

## Scales (Balance) Menu,, Submenus, System, Peripherals

It is common to use the term scale or scales in place of balance. They are technically different however for the sake of clarity 'scale' has a more intuitive annotation.

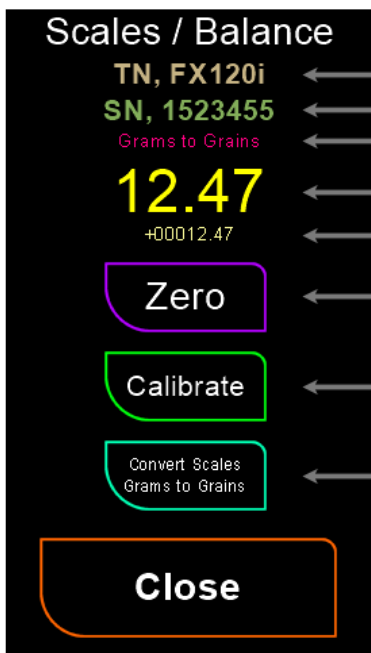

1. A&D model number.
2. A&D serial number.
3. Shows if the display has been converted from Grams to Grains (see button 8 just below).
4. The scale value.
5. The data stream sent from the scale to the SuperTrickler. This can be critical information when trying to diagnose a communications error.
6. This will re-zero the scale.
7. This button takes you to the Scales Calibration page.
8. As some A&D models only work in Metric Grams, turning this on will convert the weight from the scale into Grains.

## Powder Cup Scales Monitoring Menu, Submenus, System, Peripherals

The Powder Cup Setup uses the scale to read the weight to determine the status of the powder cup.



**On weight range min:** this will be a negative value just below zero where an empty cup would be considered close enough to “Empty on the scales”.

**On weight range max:** this will be a positive value just above zero where an empty cup would be considered close enough to “Empty on the scales”.

**Off weight:** this will be a negative value well below zero where the cup would be considered as removed or “Not on the scale”

**Ready Settling:** this is a time in milliseconds that allows the scale to stabilise after an empty cup has been put back on the scale. If this time is too short, you may be zeroing the scale before they are stable, generating an error and possible incorrect charge.

## Powder Cup Laser Sensor Menu, Submenus, System, Peripherals

**Note:** This is experimental technology, as a result is turned off by default.

The SuperTrickler is equipped with a laser sensor to detect the cup. This functionality is optional (enable/disable) and can help prevent starting a charge without the powder cup in position. This system is used, in conjunction with the powder cup monitoring system, to ascertain the status of the powder cup. Other systems on the market generally just use the weight on the scale to determine this and prevent starts without the cup in position. However, with this comes a serious compromise, in that the scale is not re-zeroed before each charge and only allows the use of one powder cup or cups that are precisely the same weight. The laser helps to overcome this issue and several cups can be used without any consideration to weight. It is recommended the same cup design be used to allow the laser to detect the same dynamics.

The program will display an oscilloscope-type wave form of the laser distance as a visual guide, along with the cup status picture as detected by the laser and the laser distance reading. There are 3 settings that need to be set in order to configure the laser, if enabled:

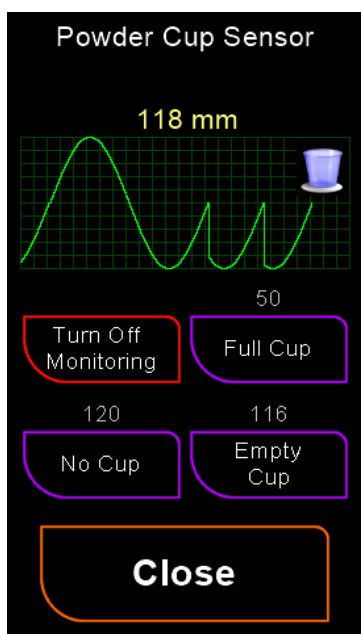

**Turn Off Monitoring:** disables the laser system, and the system will rely solely on the cup weight to determine the cup status. There is no compromise on accuracy doing this as the SuperTrickler will still perform a zero at the beginning of each charge. However, you can also start a charge accidentally without the powder cup in position.

**No Cup:** is the distance when no powder cup is present.

**Empty Cup:** is the distance when the powder cup is present and empty.

**Full Cup:** is the distance when the powder cup is present and full of material.

The best way to calibrate this is to simply place the cup in the state required and press the associated button (No Cup, Empty Cup or Full Cup) and the current reading will populate the keypad entry. You can press OK to accept that value or change it as required.

## Date & Time Menu, Submenus, System

The SuperTrickler has a built-in Real Time Clock, tracking the time and date. The format of the date can be selected to suit your country's standards and preference for 12- or 24-hour time format.

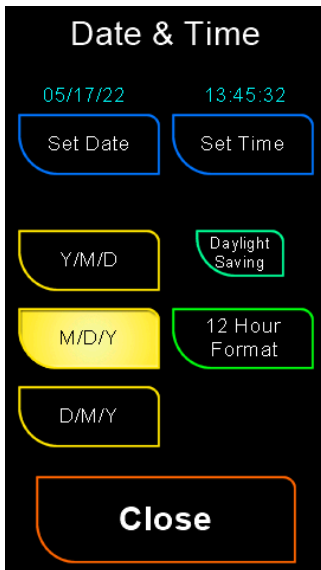

When selecting, the keypad will automatically format the time or date for you, so it is important to first select the date and time format preferred and daylight saving (on or off) before setting the time and date.

Daylight Saving does not automatically put the system into daylight savings tracking, rather it is a convenient way to subtract an hour (DLS on) or add an hour (DLS off) to the current time.

**Note:** Real Time Clocks are subject to drift. In order to keep your log file record times accurate, it is recommended to check the time regularly with a known accurate time source and adjust the time accordingly.

## Expansion Port Menu, Submenus, System

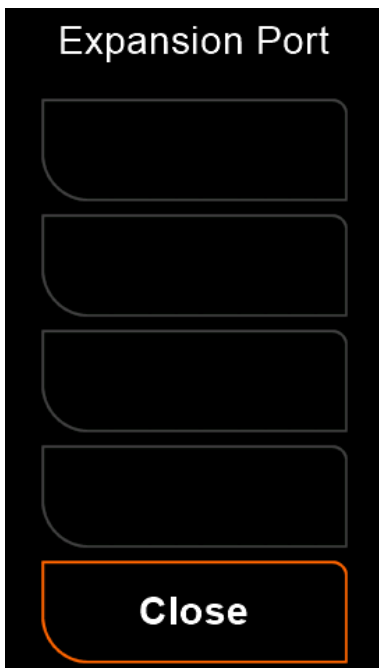

**Future:** At the time of writing there are no expansion port configurable devices.

**NOTE:** The standard robotic interface (External Control) is controlled via the Options Menu.

## Setup Menu *Menu, Submenus, System*

The system Setup menu is the operational core of the system's heart. From here you can configure the default powder profile, adjust the vibrator motor speed range, access the core system functionality and access the factory restore menu.

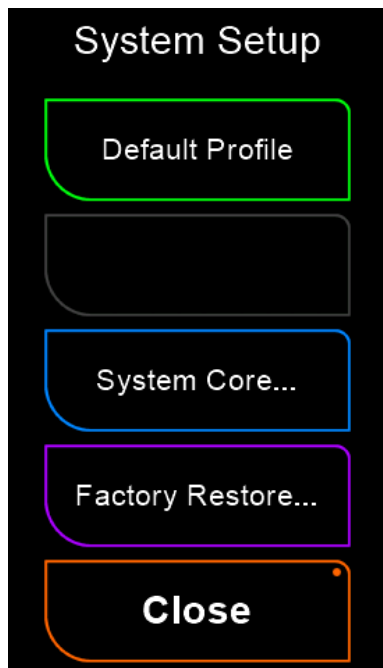

**Default Profile:** is the profile used when no other previous profile can be found for a given powder. It is also the profile used when initiating a "Restore default" to an existing profile. See Powder Profile for more details.

**System Core:** is a menu of the non-specific core system functionalities.

**Factory Restore:** takes you to a menu that allows you to select a section of the system that you may want to restore to factory defaults.

## Restore *Menu, Submenus, System, Setup*

Rather than a single factory restore that restores every setting back the factory setting, the SuperTrickler has broken this down into several sections. To do a complete factory restore all five of the restores must be carried out.

Each restore button must be held in for at least two (2) seconds before the restore will take place to avoid unintentional execution.

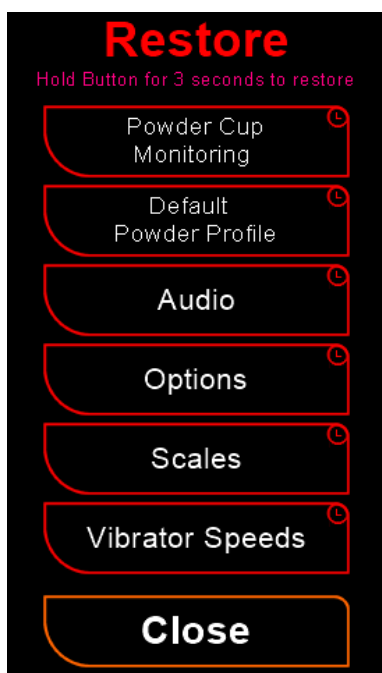

**Powder Cup Monitoring:** will restore both the laser and scales powder cup monitoring settings.

**Default Powder Profile:** will restore the current default powder profile to the factory settings. It does not change any of the powder profiles.

**Audio:** restores all the audio beeper settings.

**Options:** this will restore all of the options back to factory settings except for Audio.

**Scales:** will restore the scale stabilisation times etc. back to the factory settings

**Vibrator Speeds:** will restore the vibrator speeds back to the factory settings



## Core Menu, Submenus, System, Setup

The system core menu is the deepest area of the system's heart, allowing you to access the firmware updates and initiate a system basic self-test.

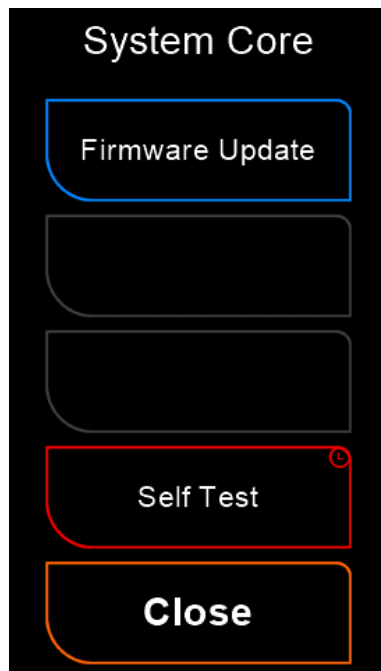

Firmware Update when the system detects a new firmware update on the SD card, it will automatically take you to this page. You may wish to simply exit the page and do the update at a later time.

**NOTE:** In some circumstances, an update may be initiated without intervention (as soon as it's detected).

Self Test will run a self-test program (mostly for use by service technicians).

## Firmware Update Menu, Submenus, System, Setup, Core

The firmware update system is a powerful system, where a single update file can be downloaded from the web, copied onto the Micro SD card and installed on the system. Unlike many other systems you may have encountered, the SuperTrickler update system takes great care to ensure each update file is 100% corruption free. These files are both tamper and corruption checked for 21 facets before beginning an update. The system can be reversed to previous versions if required. Upon completion of the update, the updated file will be removed from the Micro SD card.

### NOTE:

1. It is highly recommended that the update information be studied prior to running an update, as in some circumstances the update will initiate a factory reset of one or more areas of the system.
2. When the system detects a new firmware update on the SD card, it will automatically take you to this page. You may wish to simply to exit the page and do the update at a later time.
3. In some circumstances an update may be initiated without intervention (as soon as it's detected).

**Warning:** during an update, the green work light will flash, indicating firmware progress. Green was chosen, as it has the least potential to trigger epilepsy, however, if you are prone to epilepsy, it is recommended to look away during the update. Adequate time will be given with a warning before this process begins.

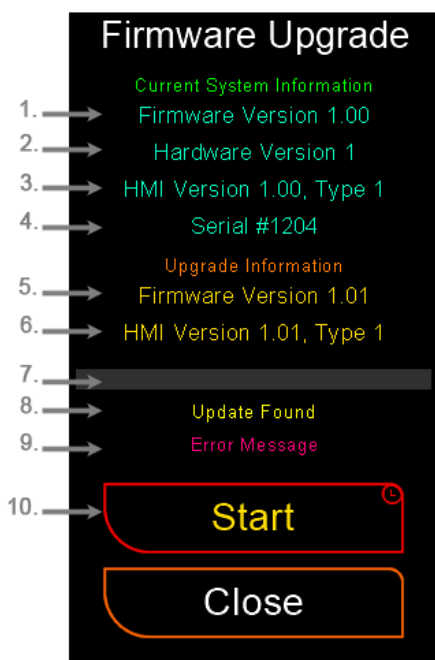

1. Current controller firmware version.
2. Hardware (controller board) version.
3. Current HMI (Human Machine Interface) touchscreen firmware version and hardware type.
4. Machine serial number.
5. The controller update firmware version.
6. The HMI update firmware version.
7. File unpacking and checking progress bar.
8. Status and process information messages.
9. Error message.
10. Start button; this button must be held in for over a second before the update starts to avoid unintentional execution.

To obtain firmware updates please go to: <https://supertrickler.com.au/st101firmware>

## Update Error codes

Code	Reason	Fix
E0: Undefined Error	This error is caused by undefined reasons and should not occur.	
E1: cannot open file	The .STF file cannot be opened.	Check SD disk format and reinstall the .STF file
E2: unknown format	The .STF file format is an unknown type.	Download & reinstall the .STF file
E3: descriptor size	The part of the file that has the update information is not the correct size.	This may be caused by upgrading from a very early version to a much later version.
E4: descriptor checksum	The descriptor data is corrupt	Download & reinstall the .STF file
E5: retired format	The update file is no longer supported	Download the latest or matching .STF file
E6: not valid file	The file marker STPK is not present	Download & reinstall the .STF file
E7: wrong product	The file is not suitable for your SuperTrickler product code	This is rare and is possibly caused by using a special .STF file
E8: wrong serial	The .STF is not compatible with registered serial number	
E9: ctrl firmware version	The controller board firmware is not compatible with HMI update.	Download the latest or matching .STF file
E10: HMI firmware version	The HMI version is not compatible with the controller firmware version.	Download the latest or matching .STF file
E11: ctrl hardware version	The controller board hardware (board type) is not suitable for this controller firmware	
E12: HMI hardware type	The HMI hardware (Display type) is not suitable for the HMI firmware.	
E13: creating ctrl file	There was a problem creating the file that the controller firmware is unpacked into.	Check SD disk format or disk space
E14: ctrl write size	The unpacked controller firmware file did not unpack to the correct size.	Check SD disk format or disk space
E15: ctrl read checksum	The data area of the .STF if corrupt.	Download & reinstall the .SFT file
E16: ctrl write checksum	The unpacked controller firmware file did not write correctly.	Try again
E17: ctrl position	The controller part of the .STF file could not be accessed	Download & reinstall the .SFT file
E18: HMI data size	The size of the HMI data in the .STF is not correct	Download & reinstall the .STF file
E19: HMI read checksum	The HMI data is corrupt	Download & reinstall the .STF file
E20: HMI baud rate	The HMI connection speed could not be established	Turn off and restart the SuperTrickler
E21: HMI file position	The position of the HMI data could not be found	Download & reinstall the .STF file
E22: ctrl firmware failed to load. (or the light does not flash for a while)	The controller firmware failed to load from the SD card. The format of the SD card is very important. The max size is 32GB (FAT 32)	Use a compliant SD card formatted using the SuperTrickler and retry.

## Charge Log Files

The data logging ability of the SuperTrickler is an important feature. There are two main log files stored on the micro-SD card under a folder called \log. The files are Comma Separated Values (CSV) files, which can be opened on any spreadsheet program or text editor.

The log file size is limited to 3.9 gigabytes (an enormous amount of data), however it is recommended from time to time to back the files up and remove them as they grow too large (see Data Log File Backup below).

**Note:** If you remove the files, the SuperTrickler will recreate the missing files.

For successful loads, the file is called “\log\loads.csv”. There are 2 formats available for this file. One saves some space by only writing the powder, batch and total powder used when the profile is changed. The ‘log every line’ format logs this information on every line. The file has the following standard fields:

**Date,Time,Preset,Powder,Batch,P.used,Consecutive,Fill Time,Volume,Setpoint,Tolerance,Error,Process**

Date is the date the charge occurred.

Time is the time of the charge.

Preset is the preset used to create this charge.

Batch is the batch value, if set.

P.used is a running total of the powder used for successful loads since the powder or preset was changed.

Consecutive is the number of charges since the last error.

Fill Time is the time it took to create the charge. Note: this does not include the ‘final’ analysis time.

Volume is the volume of the cartridge set under pre-sets if it has been set.

Setpoint is the target charge weight.

Tolerance is the tolerance setting for this charge.

Error is the difference between the Setpoint and the actual charge loaded.

Process is a coded string contain AI information on how the load was made.

**NOTE:** if you desire extra fields for your own records, you can edit in extra headings using spread sheet software or a text editor AFTER you save the log file locally on your computer.

For **failed** loads the file is called “\log\error.csv”.

The error file only logs failed loads and contains all the same fields as the successful loads (above), however has more extensive information that can be used by our support team to analyse the reasons why the failed load occurred. A single or rare failed load is not of particular interest to the support team. However, should you be continually having trouble this file can be emailed to our support team. [support@supertrickler.com.au](mailto:support@supertrickler.com.au)

## Log File Backup

Backing up your log files is recommended from time to time, using a laptop or personal computer. Note: You may need a Micro-SD to SD card adapter if your computer does not directly support Micro-SD cards.

1. Remove the Micro-SD card from the SuperTrickler (press down, release, then remove).
2. Insert the card into your computer.
3. Navigate into the Log folder.
4. Copy the .CSV file to a location on your computer.
5. If a file is getting large (nearing the 3.9GB limit) it is recommended to remove the large file, the SuperTrickler will recreate a new file automatically when the card is reinserted.
6. Once the backup has completed, reinsert the card back into the SuperTrickler (press in until it clicks).

## Powder Profile Menu, Start, Profile

The Powder Profile is a collection of information that defines the characteristics of the powder (or pre-set) and the SuperTrickler uses this information to control the process of dispensing the powder.

There are many settings in the powder profile that, at first, may seem overwhelming, however, with minimal experience, most of the main settings will become second nature. Many of the settings have adequate defaults and the (AI) self-learning will get you started. The trade-off for this complexity is speed and the variety of powders that it can handle.

The SuperTrickler is capable of dispensing with incredible speed but it's not going to be able to do that without a lot of details about the powder. Many machines on the market today struggle with the wide variety of powders available, so they compromise or trade the complexity required for simplicity, narrowing the range of powder that performs well with their machines.

Further to this, the SuperTrickler maintains a database of every powder or pre-set profile, so you are not repeating the learning, calibration or setup process every time you change powder. Each powder and pre-set has its own profile, starting with a default profile that is setup to allow the Artificial Intelligence (AI) self-learning to do most of the work to get you up and dispensing. You can either run with that or start tweaking the system to either optimise speed or consistency.

**Note:** do not expect 100% successful charges unless you want to trade dispensing speed for time.

## Terminology

- **AI:** Artificial Intelligence – a system that uses weighted factors in relation to the information at hand to create an outcome.
- **Tubes / Trickler:** The physical trickler tubes, the rotating bulk tube and the vibrating fine tube.
- **Instrument:** How the system uses a given tube to deliver powder. Bulk, Fine, Slow & Pulse.
- **Speed:** How fast an instrument is rotating or vibrating.
- **Ramp:** To change the speed smoothly up or down.
- **Inflight:** is the powder that has left the tube but not yet landed in the receiving powder cup.

At the core of the SuperTrickler, several separate AI engines work together to deliver you a result. The two of importance in this discussion are the:

1. AI Orchestrator: supervises the charging operation.
2. AI Self-Learning: learns the mistakes made by the AI Orchestrator. Even if the self-learning is disabled from making changes to the profile, it still runs in the background and can assist the operator in fine tuning the profile manually. How to do this will be released in a SuperTrickler Masters video series planned for the future.

### **Sequencing**

It is important to understand that there is no set sequence of dispensing control that you may have seen in other systems. The AI dynamically assesses the progress of the charge and might change the given instrument or method of dispensing at any point in the process. Each instrument used is trying to deliver the correct amount of powder. However, with speed comes inaccuracy, so if an instrument failed to deliver the exact amount of powder, the AI Orchestrator evaluates the next instrument to overcome the shortfall.

As you begin to understand how the AI thinks, you will be able to trim the profile settings to gain the optimal outcome for your needs. The AI Orchestrator does not have eyes and ears to observe the nature of the powder and how each charge is going; it uses relatively blind data to work so with and your eyes can be of great assistance to the Orchestrator, by manually adjusting some of the settings.

It is important to note at this stage that operators have different values; some will value consistency at the cost of time, some will value time, accepting more overcharges, some to the extreme and some to mediocrity. It is impossible for the AI to read your mind and to know what you value the most and exactly how you prefer the SuperTrickler to behave with a given powder.

Powder and grains are notoriously difficult to accurately dispense, as some tend to stick and clump while other powders will flow like water. Most dispensers on the market try to make a compromise (one size fits all) on the control system to suit most powders and generally, do a pretty good job. The SuperTrickler allows you to fine tune every powder with the system, remembering those settings, for the next time you select that powder. This feature gives the operator enormous power over how the SuperTrickler will operate across the spectrum of powders.

The problem is that not everyone wants to be a super-user and to fine-tune everything down to a tee. This is where the AI self-learning comes in. The AI self-learning ability adds a new dimension to powder dispensing, by trying to figure the characteristics of the powder on the fly and learning by its mistakes. It is important to understand that the AI self-learning job is not to optimise the system, rather to find a happy medium, where most charges will be consistently accurate with few rejected overcharges. The best fine tuner is the operator, as it is only the operator who knows what they value most. We intend in the future, to release one or more videos on how to fine-tune and optimise the profile for power users. For many users, simply putting the powder in the unit, selecting the powder from the list and letting the AI self-learning do its thing, will be more than adequate for their needs.

### **Control System Philosophy**

To optimise the results from the SuperTrickler, understanding the control system philosophy is an advantage. Similar dispensers on the market utilise either a Proportional Integral Derivative or a simple Proportional Sequenced Controller. We have chosen to go down a different path by utilising artificial intelligence on several areas of the operation. Any form of proportional controller suffers

from a fundamental problem, in that it relies on the reaction (how fast to run) as a proportion of the error (how much more to dispense). The closer to the target you get, the smaller the error, resulting in a smaller reaction.

Theoretically, a proportional controller alone can never reach the target. The closer you get to the target, the less reaction or the slower the machine runs to the point that no practical reaction or speed is taking place just before the target set-point. There are several ways to overcome this and commonly the systems employed are, either or both, having a minimum speed and or an aiming set-point above the desired outcome target set-point. These systems work exceptionally well, however proportional controllers need and take time to achieve their results.

The SuperTrickler in comparison, attempts with each instrument to throw the correct amount of powder as quickly as possible. The system has no set sequence, and the AI Orchestrator evaluates each attempt and then reacts to the results. Unlike proportional control systems, the SuperTrickler aiming set-point is always at the lower end of the tolerance. The disadvantage of this type of system is a greater susceptibility to overthrows. However, the advantages are speed, and the flexibility for the operator to choose fast times with a higher reject rate, or a conservative slower time with a low or no reject rate. The balance is at the operator's discretion and ability to command the parameters. Further to this, if so desired, the SuperTrickler can be configured to operate as a proportional controller, if speed is not an important factor over consistency.

## Vibrator Speed Settings

**Important: This must be set when an un-profiled powder is selected.**



These settings set the minimum and maximum speeds of the vibrator motor from a value between 1 and 255. Once set, the range will be represented by the rest of the system as a percentage of minimum (1%) and maximum (100%) setting speeds. Use the arrows to change the values, and the x10 button to change by 10 or by 1 for each press. To change between Maximum and Minimum either press the swap button or tap the appropriate heading.

Min is the value that represents 1% speed.  
Max is the value that represents 100% speed.

Set the Maximum speed high enough to obtain as high a flow as practical without having the kernels miss the cup. (Too fast and the kernels will overshoot the cup)

Set the Minimum speed low enough so a single or a small number of kernels are dispensing from the tube.

## Instruments

Instruments are the way in which a given tube is used in relation to a set of parameters. Apart from the pulsating instrument, all other instruments can be turned off by setting their speed to zero.

- **Bulk:** Rotation tube, design to dispense a large amount of powder as fast as possible. Note: The Fine Tube is used for a period within this process to ensure the tube is primed and ready for use (if required).
- **Fine:** Vibrating tube, designed to dispense any shortfall of the bulk instrument, again as fast as possible. This instrument has both a high and a low speed and at a given point nearing the target weight, it will ramp down from the high speed to the low speed. The purpose of this ramp down is not proportional control but rather to de-load the vibrating tube (reduce the powder loading in the tube) ready for any following instruments if required.
- **Slow:** The slow instrument runs the vibrating tube at a constant speed to make up the shortfall left by any of the previous instruments. Generally, if the Fine is set carefully, the slow instrument is not required and, as such, is defaulted to the off state.
- **Pulsating (Pulse):** Uses the fine tube, running at a constant speed while turning ON for a period of time, then OFF for a period of time, until any shortfall from the previous instruments has been fulfilled. This instrument cannot be disabled.

To help you set the speeds for the instruments, there is a handy tool under profile pages of each instrument that allows you to test-run the tubes and physically observe and set the speeds to gain a desirable powder flow. The AI self-learning will attempt to adjust the speed of the Fine and Slow instruments, unless they have been set via this method and a message “Self-learning speed locked” will appear on the profile screen to indicate this affect.

## Profile Variables

The powder profile is a container of variables that tell the AI how to react during the dispensing process. These variables are grouped into logical sections to reduce the overall complexity:

- Basic – tolerance, final stabilisation.
- The bulk delivery instrument.
- The fine delivery instrument.
- The slow delivery instrument.
- The pulsating delivery instrument.
- Self-Learning.

So, let’s look at the profile screens with a description of the variables and their functionality.

The opening screen: in this screen you can change the tolerance and behaviour, restore the default settings and branch into the instrument settings.



Tolerance: is the acceptable bandwidth of a given charge and has a range of 0.10 to 0.00 grains. Giving the system a tolerance value of 0.00 or no tolerance is the re-loaders dream, however, it does come with a price in that you are going to get many rejected over charges. It is important to also understand that with some powders you may have individual grains that can weigh 0.06 grains or more. However, testing has shown that the powders average out and having a tolerance below the grain weight is still achievable, especially with larger charges.

Tolerance offset: notice the clock on the top right hand side of the button. To avoid accidental activation of the button, it must be held for a short time before the selection changes.



The tolerance offset changes the way the AI will target the charge set point and evaluate an acceptable or unaccepted rejected charge.

{+/- Either Side} The default is + or – the tolerance value, this means in this case 0.02 grains below the set point or 0.02 above the set point is acceptable. Note the bandwidth is 0.04 grains.

{+ Above Setpoint} is the next option, where in this case, the AI will attempt to dispense to at least the set point (never below it) with an acceptable charge being from 0.00 to 0.02 above the set point.

{(-) Below Setpoint} is the last option, where in this case, the AI will consider an acceptable charge to -0.02 to 0.00 below the set point and never above it.

**Final Stabilization Time**: This is a critical time in milliseconds (1000 mS = 1 second) that is delayed at the end of the charge, allowing the scale to stabilize (settle) before evaluating if the charge needs more powder, or is within tolerance as a successful charge, or if the charge is to be rejected as an overshoot. If this value is too low, you may find the charges are resulting in undershoots and if it's too long, then you waste unnecessary time. Generally, two seconds (2000 mS) is about right, but for fine grain powers this value could possibly be reduced and for large grain powders, this value may need to be increased as the heavy grains create vibrations in the delivery powder cup and scale.

**Note**: A&D recommend at least one second minimum for the scale to stabilize.

**Restore default**: Will reset all the parameters to the default settings. To avoid accidental activation of this button, it must be held in for a few seconds.

**Bulk**: Will take you to the bulk specific settings page.

**Fine**: Will take you to the fine specific settings page.

**Slow**: Will take you to the slow specific settings page.

**Pulse**: Will take you to the pulse specific settings page.

**Self-Learning**: Will take you to the core self-learning enable/disable and behaviour settings.

## Bulk Instrument

This screen has all the relevant parameters for the bulk trickler tube. This tube is directly driven by a rotating stepper motor onto the base of the tube. Its fundamental purpose is to dispense the bulk of the powder as fast as possible.

### Process of the Bulk Instrument.

The fundamental process is as follows:

1. The bulk instrument is evaluated as being suitable for the charge at hand., and if so then;
2. The rotating trickler is ramped up from 0 to the operating speed over time;
3. About one second after it starts to turn, the vibrating trickler start to prime the tube for later use;
4. The flow rate is monitored and about 1 second before the rotating trickler is due to stop the vibrating trickler is stopped;
5. When the weight reaches the aim-point (set-point minus the bulk inflight) the rotating trickler stops;
6. The results of the instrument usage are evaluated.

### Bulk Instrument Parameters

The instrument has five parameters in its operation as follows...

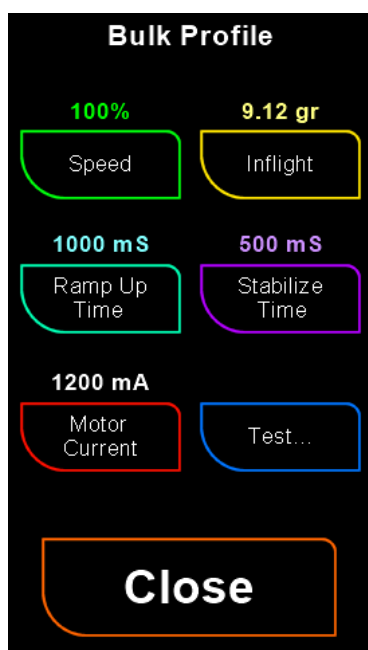

**Speed:** This is the rotation speed from 0 (off) to 100%. It is important to understand that although 100% is the default, this may not be the best speed for your powder. Powders that do not flow very well may clump and tumble inside the tube and slowing it down may give a more consistent output. The more consistent the output, the better the system will run, as it can more accurately predict the inflight powder amount, resulting in the bulk dispensing very close to, or on, the target weight.

Should the bulk instrument not be required, setting the speed to zero will disable its use.

**Inflight:** The material still in the air between the end of the tube and the powder cup once the trickler instrument stops and is a critical value for the dispensing process. In the case of the bulk trickler, the self-learning does not change the motor speed, however, any overshoot error will be recognised as powder inflight and this value will be changed.

**Ramp Up Time:** The bulk trickler motor is a hefty motor, and rather than force a huge strain on the componentry when the motor starts, the use of a soft start or ramp-up is employed. This is the time it takes to go from zero speed to the setting speed. You may want to slow this down with heavy powders or speed it up with light powders. A setting of 0 milliseconds is acceptable, but not recommended, with heavy powders.

**Stabilize Time:** This setting controls the amount of time in milliseconds (1000 mS = 1 second), to give the scale time to stabilize (settle) before evaluating the results. Ideally, this time should be at least one second, however practical testing has shown that, in general, around 500 milliseconds is adequate. If the time is too short, you may find another instrument will kick in operating in a manner unsuitable for the remaining charge, and, if the time is too long, you waste unnecessary

time. For power users seeking speed, you may want to set this very low to say around 100 mS, however, it is recommended that if you do this, then increase the inflight value to compensate for the reduced time.

**Motor Current:** Powder comes in many shapes and sizes, and some will put more strain on the motor and componentry than others. The setting can be changed between 500-2000mA (0.5-2A). Higher value will compensate for heavier powders, and it can be set to lower values for friendlier powders. The default is 800mA and in the event you find the bulk trickler tube stalling (failing to rotate), this value can be increased to compensate.

Values below 1400mA are shown in white and are considered low current settings and 1400mA or above will display in red, indicating high current settings. The higher the current, the noisier the motor will run and will put more strain on the motor and components to the point where it may shutdown due to thermal overload, shutting the motor off for a few seconds while the components cool - the lower the setting the better.

**Test:** This will take you to a page that will allow you to test the bulk speed. From this page you can run the motor and adjust the speed while observing the behaviour of the powder flow.

**Motor Current:** The test page also has an option to automatically set the motor current, by pressing the Auto Motor Current button. When you press this button, the speed will be set to 100% and the motor will start at the lowest current setting. If the motor stalls, it will be turned off, the motor current readjusted to a higher value, then restarted again, repeating until a stable current is found or the maximum is reached.

## Fine Instrument

The purpose of the fine instrument is to rapidly make up any shortfall left by the bulk instrument, if used, or rapidly fills smaller charges where the bulk instrument is not used.

A vibratory system is significantly different to a rotating trickler tube. In a rotating tube, changing the speed of the tube gives a relatively instantaneous change in powder flow. A change in the speed of a vibrating trickler tube does not give an instantaneous change in powder flow, as the amount of powder loading in the tube is a result of the speed of vibration that has previously taken place. However, it does have a significant advantage of being able to trickle very precise amounts of powder.

## Process of the Fine Instrument.

The fundamental process is as follows;

1. The fine instrument is evaluated as being suitable for the charge at hand, and if so then;
2. The remaining weight is evaluated and a decision for a start speed from between the high-speed setting and the low-speed setting is calculated;
3. The vibrating trickler starts;
4. At the aim-point weight, less the ramp down weight, the vibrating speed will begin to be reduced down to the low-speed setting;
5. When the weight reaches the aim-point (set-point minus the fine inflight) the vibrating trickler stops;
6. The results of the instrument are evaluated.

## Fine Instrument Parameters

The instrument has 6 parameters in its operation as follows:

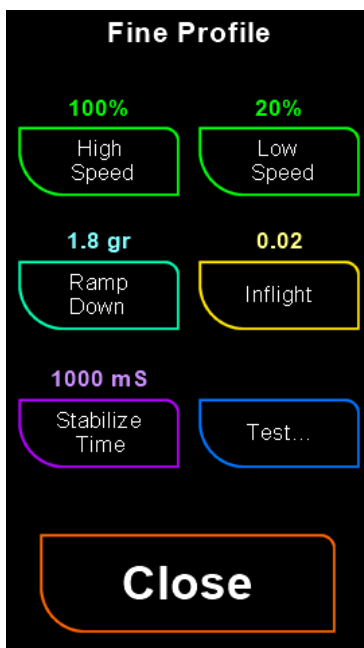

**High Speed:** This is the maximum speed as a percentage that the vibrating trickler operates. **Note:** this speed is not changed by the self-learning system. Setting the speed to zero will disable the use of the fine instrument.

**Low Speed:** This is the minimum speed as a percentage that the vibrating trickler will operate at the end of the ramp down. **Note:** this speed is changed by the self-learning system, unless locked. Setting the speed to zero will also disable the use of the fine instrument.

**Ramp Down:** This is the weight before the weight aim-point is reached, when the vibrating trickler will begin slowing down. If this is too small, the fine instrument may overshoot the aim-point. If this is too large, the trickler will take unnecessary time to slow down. The self-learning will only ever set this to an initial value.

**Inflight:** This is the material still in the air between the end of the tube and the powder cup once the trickler instrument stops and is a critical value for the dispensing process. The self-learning will change this value.

**Stabilize Time:** This setting controls the amount of time in milliseconds (1000 mS = 1 second), to give the scale time to stabilize (settle) before evaluating the results. Ideally this time should be at least one second, however, practical testing has shown that in general around 500 milliseconds is adequate. If the time is too short, you may find another instrument will kick in operating in a manner unsuitable for the remaining charge, and if the time is too long, you waste unnecessary time. For power users seeking speed, you may want to set this very low to say around 300 mS, however it is recommended that if you do this, then increase the inflight value to compensate for the reduced time.

**Test:** This will take you to a page that will allow you to test the fine speeds. From this page you can run the motor and adjust the speeds while observing the behaviour of the powder flow.

**Self-Learning Lock:** From the test page the motor speed can be locked from the self-learning system.

## Slow Instrument

The slow fine instrument will not generally be used; however, it may have a purpose for some charges and powders. It can be used in conjunction with the Fine and Pulse instruments, or can replace the role of either of these instruments.

The AI Orchestrator in its evaluation will generally follow this sequence:

1. Bulk Instrument if enabled and if suitable;
2. Fine Instrument if enabled and if suitable;
3. Slow Instrument if enabled and if suitable;
4. Pulse Instrument if enabled and if suitable.

### Process of the Slow Instrument.

The fundamental process is as follows:

1. The slow instrument is evaluated as being suitable for the charge at hand, and if so, then;
2. The vibrating trickler is started at the slow speed;
3. When the weight reaches the aim-point (set-point minus the slow inflight) the vibrating trickler stops;
4. The results of the instrument are evaluated.

### Slow Instrument Parameters

The instrument has 3 parameters in its operation as follows...

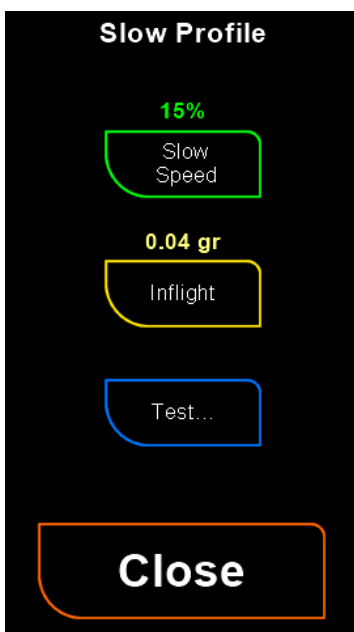

**Slow Speed:** This is the speed as a percentage that the vibrating trickler operates. **Note:** this speed is changed by the self-learning system unless locked. Setting the speed to zero will disable the use of the slow instrument.

**Inflight** is the material still in the air between the end of the tube and the powder cup once the trickler instrument stops and is a critical value for the dispensing process. The self-learning will change this value.

**Test:** This will take you to a page that will allow you to test the fine speeds. From this page you can run the motor and adjust the speed while observing the behaviour of the powder flow.

## Pulse Instrument

The purpose of the pulse instrument is to carefully make up any shortfall left by the previous instruments used. The pulse is the only instrument that cannot be disabled. Pulsing can deliver a small amount of powder down to a single grain if set up correctly. The downside of pulsing is that it takes time to release a quantity of powder, then stops and waits for it to land in the powder cup and be evaluated. The upside to pulsing is that it is very good at giving a precise final finish to the charge.

### Process of the Pulse Instrument.

The fundamental process is as follows:

1. The pulse instrument is evaluated as being suitable for the remaining charge at hand, and if so then;
2. The vibrating trickler is started for a short time measured in milliseconds at a set speed;
3. Once the on time has been achieved the vibrating trickler will stop. A wait time measured in milliseconds is allowed to pass, allowing for the powder to fall into the cup and be measured by the scale;
4. An evaluation is made and if the weight is still short of the aim-point, the process repeats until such time as the weight reaches the aim-point.

### Pulse Instrument Parameters

The instrument has 3 parameters in its operation as follows:

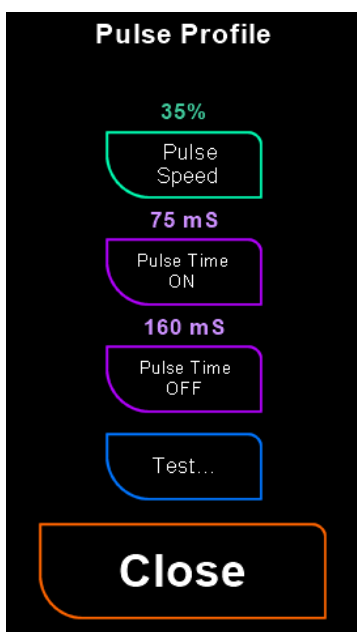

**Pulse Speed**: This is the speed as a percentage that the vibrating trickler operates. **Note**: this speed is changed by the self-learning system unless locked.

**Pulse Time ON**: Is the vibrating trickler running time in milliseconds.

**Pulse Time OFF**: Is the wait time in milliseconds that allows for the powder to fall to the cup and be measured by the scale.

**Note**: It is feasible to have the pulse ON times very short with lighter powders. The vibrating trickler can operate with very quick consecutive pulses. The caveat for this type of operation is that the powder granule weight and in-flight granules fall within the charge tolerance.

**Test**: This will take you to a page that will allow you to test the pulse speeds. From this page you can run the motor and adjust the speed while observing the behaviour of the powder flow.

## AI Self-Learning Settings

The self-learning feature is designed to help you quickly establish the profile settings. Nothing can beat the operator's eyes, ears and intuition when it comes to fine tuning. The goal of the self-learning is to get the settings in a good place for the operator, should they wish to make fine tunings.

The self-learning system uses artificial intelligence to make reasonable changes to the settings, determined by overshoots and operational performance monitoring (like what we as humans would do, but without eyes, ears and gut feelings). The systems use a combination of errors, state, expectations and neural triggers to determine if the self-learning should react and what to change. The system may make changes to the profile, even though the charge itself was successful, if it sees a potential to better control parameters. The system does not try to react to every error, as this would result in the system running slower and slower over time. It is the nature of gun powder to flow inconsistently and the AI attempts to take a reasonable guess, searching for a balance of speed and errors during this process.

It is beyond the scope of this manual to explain the complexities of AI self-learning, or even much of the terminology. Therefore, it is much easier to simply accept the parameters as a guide to the self-learning, giving you the type or near to the type of results you are after. In saying that, it is important to understand the functionality of the instrument's neurology.

## Neurology

Neurology is complex, however, in simple terms the neural receptors build with success and degrade with failure. Their function in the SuperTrickler is to prevent the self-learning from over-reacting to every little powder glitch. Without neurology, the self-learning would seek to make an adjustment to every single failure. It would end up never overshooting, but at the cost of speed - taking a long time to dispense every load so, the neural receptors look at both the successes and failures of an instrument, learning from them in order to prevent an error from overresponding. You could look at the neurology as a failure tolerance level.

## Self-Learning Parameters

The self-learning uses seven parameters to determine the type of learning. The screen shows the setting values and (in gray) the current successive count and a summation of the neural receptors count (if used). The parameters are as follows...

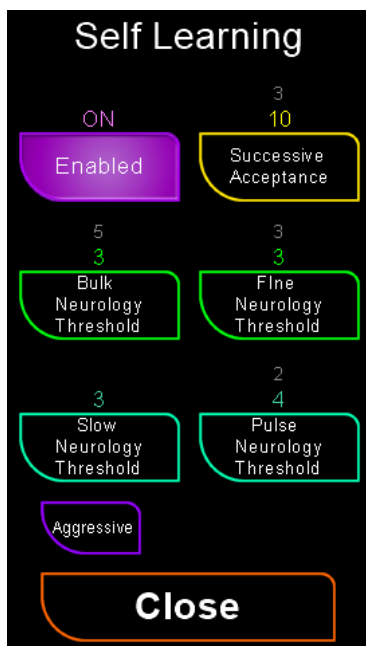

**Enabled:** Simply turns the self-learning on or off manually.

**Note:** When turning on the self-learning, all neural receptors will be reset and will require self-relearning.

**Successive Acceptance:** An automatic control that will turn off the self-learning after all the neurological thresholds have been reached and the values successful charges in a row with no failed charges in-between and been reached.

A low value will force the self-learning to be disabled after few good rounds in a row. A large value tells the self-learning to keep working until many good rounds in a row have occurred, however it may not do much once the instrument's neurology finds a happy place. If you want 100% success rate, set this value high along the neurology threshold.

**Instrument Neurology Threshold**: In some ways the neurology threshold is like the successive acceptance. The successive acceptance is an overall function to disable the self-learning and is looking only at the number of successful charges in a row. The neurology threshold is looking at individual instrument's 'neural receptors' that grow with success and degrade with failure and the threshold at which enough success has occurred to disable the self-learning for only that instrument. However, if that instrument (for whatever reason), starts to fail several times in a row, the self-learning will kick back in for that instrument. As an example, a value of three means three successes in a row by that instrument and learning stops for that instrument. However, if it succeeded three times then failed once, the instrument learning would start again. So how do we use this setting? If you desire speedy charges and are willing to forgo a few overshoots, set this value down to two or three. If you desire a 100% success rate, then set this value to a larger number. When seeking a good success rate, rather than set all the instruments to a high threshold, only set the instrument or instruments that are failing to a higher value, giving the occasional overshoot and yet maintaining good charging speed.

**Aggressive**: This switch turns on an aggressive self-learning mode. Once the AI has collected a reasonable amount of information about the powder metrics, it then reconfigures the profile to charge at an aggressive rate (fast). The advantage of the aggressive mode is its dispensing speed. The SuperTrickler is capable of some amazing speeds that are beyond the self-learning's ability to obtain, however this mode will take you a good step of the way.

**Note**: When the aggressive mode has kicked in, the self-learning scholar's hat icon, turns from blue to purple.

## **Powder Profile Summary**

Initially, the powder profile system and configuration may be overwhelming and appear complex, but with a little experience, you will find that the system is not that difficult to understand. The self-learning will manage much of the system for you, and in fact it is not unusual to simply ignore the profile and let the AI manage it completely.

Power users will always want to modify or optimise the system to suit their own values. If it all goes pear-shaped, simply hit the restore defaults and start again. At any time, you can set the inflight amounts back to zero and ensure the AI self-learning is running and let it fix the problem. In general, this is recommended after a speed change of any instrument.

The powder profile is a powerful tool, enabling great control of the system and yet can be ignored by the operator that prefers to sit back and let it do its own thing. We envisage in the future a series of Master Class videos that will give you the confidence to refine these setting to perfectly meet your needs.



## Interface Ports

Located on the rear of the SuperTrickler.

**Warning:** These connections are for the use with only SuperTrickler equipment or approved third party equipment. Any other use or connection may permanently damage the SuperTrickler and is not covered under warranty.

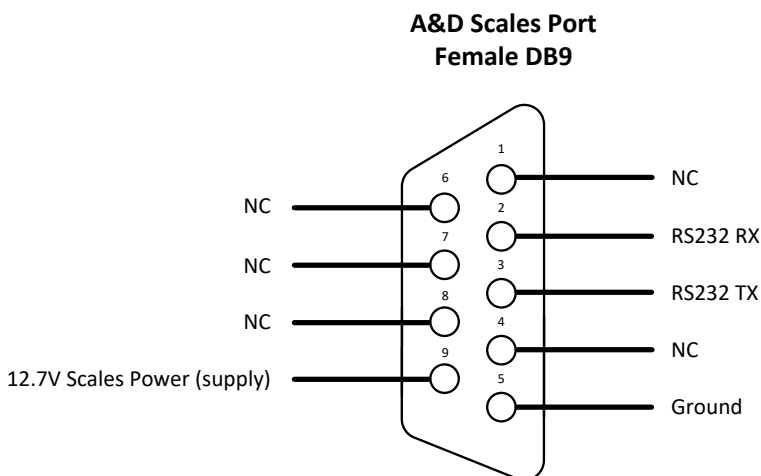
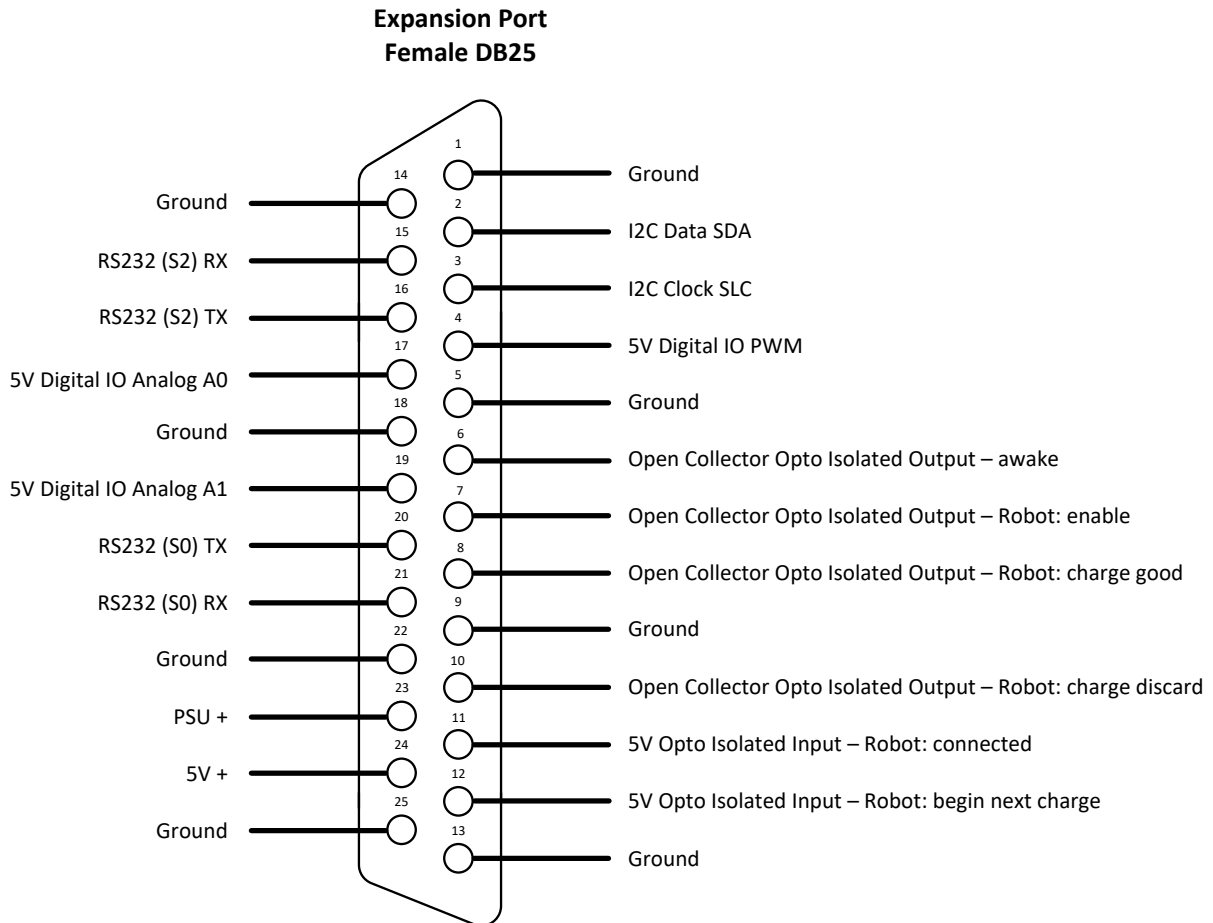

## Specifications

<b>SuperTrickler standalone unit</b>		
Empty Weight	1230 grams	
Height	265 mm (10.1")	
Width	183 mm (7.2")	
Depth	183 mm (7.2")	
Hopper volume (total)	725 grams of water	725CC (44.24 cubic inches)
Unusable Hopper volume	40 grams of water	40CC (2.44 cubic inches)
Scale Compatibility	A&D FZ/FX Series Precision Balance	With RS232 serial interface
Scale Weight Range Limit	-327.00 to 327.00 grains	Independent of attached scales
Scale Data Stream Weight Type	Grains or Grams	
Accuracy	0.02 grains	
Tolerance range	0.10 – 0.02 grains	
Compliance approvals	CE, EMC	With scale connected
<b>SuperTrickler seated on A&amp;D FZ/FX scale</b>		
Empty Weight	3760 grams	With the scale pan, powder cup and serial cable.
Height	336 mm (13.2")	
Width	187 mm (7.4")	
Depth	260 mm (10.2")	
<b>Power Supply Unit (PSU)</b>		
Type	AC to DC	
Format	Wall Socket Mount	
Input Voltage	Range 80 – 264V	Nominal 110/230V
Plug Type	AUS, EU, UK, US	
Compliance approvals	CE, UL	
Output Voltage	15V	
Output Current	4.0A	
Weight	200 grams	
Height	56.2 mm (2.21")	
Width	39.1 mm (1.54")	
<b>Power</b>		
Max	33.5W	Rotating motor shaft locked
Typical During Charge	~16W	Rotating motor at 2000 mA
Idle	6.5W	White work light on
Idle	6.1W	White work light off
Sleep	4.7W	Scale remain in sleep
Powder Down	1.4W	Via SuperTrickler control
<b>Powder Cup</b>		
Volume	25.9 grams of water	25.9CC (1.58 cubic inches)
Empty Cup Weight	43.9 grams	Standard Cup

## **Support**

Before contacting us, please refer to the frequently asked questions page:

<https://supertrickler.com.au/faq>

If you require additional help, you can contact our support team at [support@supertrickler.com.au](mailto:support@supertrickler.com.au), though please allow several days for a response as the support desk is not manned fulltime. A member of the support team may request you to email one or more files held on the Micro SD card to assist in the resolution of the problem.

## **Feedback**

The SuperTrickler was designed and developed on the concept of giving reloaders what they are asking for. We have always welcomed feedback from our followers and will extend that to our users. Not every idea is feasible however, when possible, with a great idea or with enough people asking for a change, we will endeavour to implement changes to refine the SuperTrickler moving forward. We maintain a list of future plans, ideas, and thoughts. Some of these have already been flagged for near future firmware releases that time has not permitted us to reveal in the first firmware version. The progression from idea to practical application and impact considerations is often a slow process and so it should be. The change benefit and potential negative impact, along with costs must be considered with every idea, but without ideas and an understanding of what our users want from the SuperTrickler, the product becomes a stagnate product like many similar products on the market. This is not what we want and therefore invite you to share your feedback and ideas with us by email at [feedback@supertrickler.com.au](mailto:feedback@supertrickler.com.au)